

FURUNO

MULTI FUNCTION DISPLAY

Model **TZMAP9/TZMAP13**
TZT9E/TZT13E

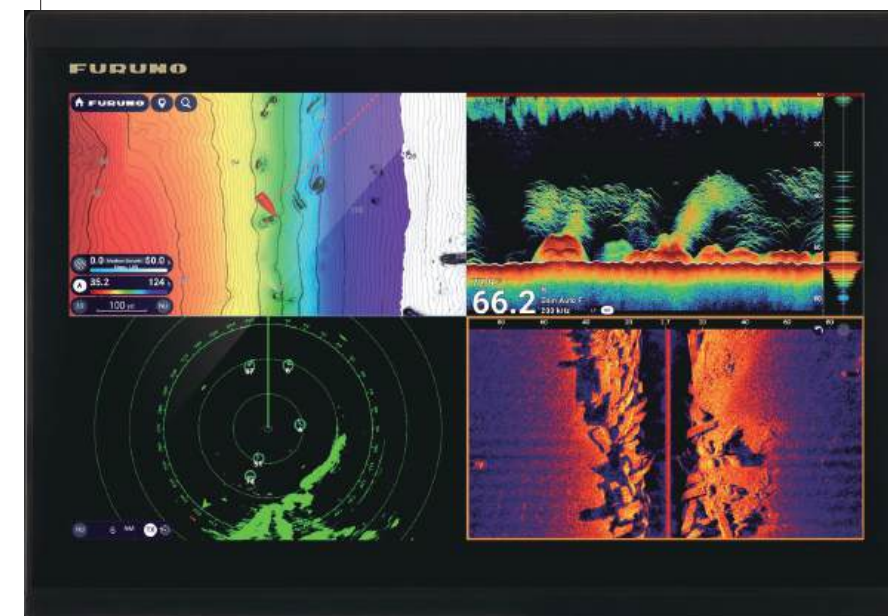
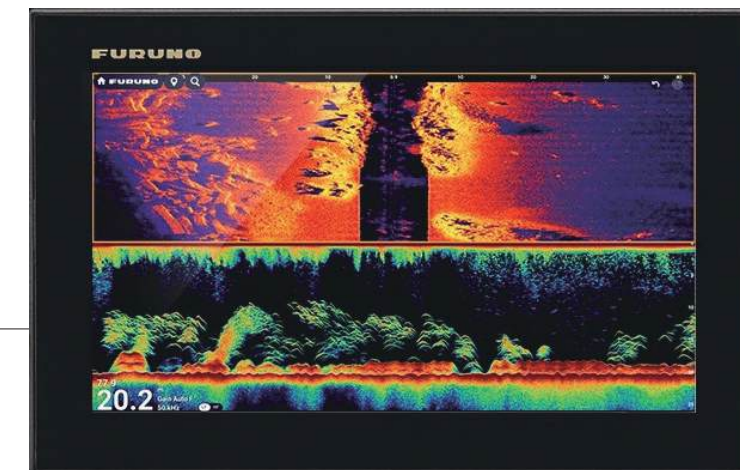

TZMAP9/TZMAP13/TZT9E/TZT13E OPERATOR'S MANUAL

FURUNO ELECTRIC CO., LTD.

FURUNO ELECTRIC CO., LTD.

9-52 Ashihara-cho,
Nishinomiya, 662-8580, JAPAN

FURUNO Authorized Distributor/Dealer

All rights reserved. Printed in Japan

A :DEC. 2025
A1 :APR.8, 2026

Pub. No. OME-45330-A1

(MENA) TZMAP9/TZMAP13/TZT9E/TZT13E



 **FURUNO ELECTRIC CO., LTD.**

www.furuno.com

IMPORTANT NOTICES

General

- This manual has been authored with simplified grammar, to meet the needs of international users.
- The operator of this equipment must read and follow the instructions in this manual. Wrong operation or maintenance can void the warranty or cause injury.
- Do not copy any part of this manual without written permission from FURUNO.
- If this manual is lost or worn, contact your dealer about replacement.
- The contents of this manual and the equipment specifications can change without notice.
- The example screens (or illustrations) shown in this manual can be different from the screens you see on your display. The screens you see depend on your system configuration and equipment settings.
- Save this manual for future reference.
- Any modification of the equipment (including software) by persons not authorized by FURUNO will void the warranty.
- The microSDXC logo is a trademark of the SD Card Association.
- The SD, SDHC and SDXC logos are trademarks of SD-3C LLC.
- Apple, App Store, iPhone, iPod, iPad are registered trademarks of Apple Inc, registered in the USA and other countries.
- Android, Google and Google Play are registered trademarks of Google, Inc.
- FLIR and ClearCruise are registered trademarks of FLIR Systems, Inc.
- FUSION-Link and PartyBus are registered trademarks of FUSION Entertainment Ltd.
- Bluetooth® mark and logo are trademarks of Bluetooth SIG, Inc.
- The following concern acts as our importer in Europe, as defined in DECISION No 768/2008/EC.
 - Name: FURUNO EUROPE B.V.
 - Address: Rotterdamseweg 30A, 2921 AP, Krimpen aan den IJssel, The Netherlands
- The following concern acts as our importer in UK, as defined in SI 2016/1025 as amended SI 2019 470.
 - Name: FURUNO (UK) LTD.
 - Address: West Building Penner Road Havant Hampshire PO9 1QY, U.K.
- All brand and product names are trademarks, registered trademarks or service marks belong to their respective holders.
- Bluetooth® module is built in the device.
- The following functions require valid license for TZ MAPS chart areas. After 1 year from the initial purchase of TZ MAPS charts, the functions will be unusable until the subscription is activated. AI Routing and AI Avoidance Route require valid TZ MAPS chart license for safety reasons.

Function	Description
AI Routing	The function is not usable without valid TZ MAPS chart license. Routes can be created and edited manually only.
AI Avoidance Route (TZT9E/13E only)	The function is not usable without valid TZ MAPS chart license and the AI Avoidance routes cannot be displayed.
Community Edit	Community objects cannot be created, edited, rated, or updated without valid TZ MAPS chart license. Downloaded community objects can be displayed on charts without valid license.
TZ MAPS chart update	TZ MAPS charts cannot be updated without valid license. Downloaded TZ MAPS charts can be displayed without valid license.

How to dispose of this product

Dispose this product according to local regulations for the disposal of industrial waste. For disposal in the USA, see the homepage of the Electronics Industries Alliance (<http://www.eiae.org/>) for the correct method of disposal.

How to dispose of a used battery

Some FURUNO products have a battery(ies). To see if your product has a battery, see the chapter on Maintenance. To dispose of a used battery, tape the + and - terminals of the battery before disposal to prevent fire, heat generation caused by short circuit.

In the European Union: The crossed-out trash can symbol indicates that all types of batteries must not be discarded in standard trash, or at a trash site. Take the used batteries to a battery collection site according to your national legislation and the Batteries Directive 2006/66/EU.

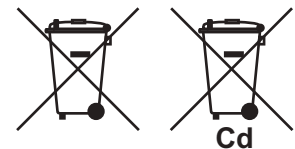

In the USA: The Mobius loop symbol (three chasing arrows) indicates that Ni-Cd and lead-acid rechargeable batteries must be recycled. Take the used batteries to a battery collection site according to local laws.

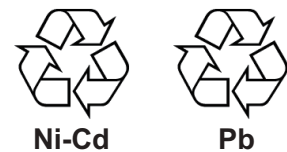



In the other countries: There are no international standards for the battery recycle symbol. The number of symbols can increase when the other countries make their own recycle symbols in the future.



SAFETY INSTRUCTIONS

Follow the safety instructions listed below and throughout this manual to prevent damage to your equipment or vessel and to prevent harm to the operator or other personnel on-board. The results of failing to follow the instructions and guidelines outlined herein are listed below.

 **WARNING** Indicates a condition that can cause death or serious injury if not avoided.

 **CAUTION** Indicates a condition that can cause minor or moderate injury if not avoided.

 Warning, Caution  Prohibitive Action  Mandatory Action

WARNING

 **The radar antenna sends electromagnetic radio frequency (RF) energy. This energy can be dangerous to you, especially your eyes. Do not look at the radiator or near the antenna when the antenna is rotating.**

The distances at which RF radiation levels of 100 W/m² and 10 W/m² exist are shown in the table.

Antenna Model	Distance to 100 W/m ² point	Distance to 10 W/m ² point	Antenna Model	Distance to 100 W/m ² point	Distance to 10 W/m ² point
DRS2D-NXT	N/A	0.7	DRS6A-NXT* (XN12A)	N/A	0.6
DRS4D-NXT	N/A	0.7	DRS6A-NXT* (XN13A)	N/A	0.4
DRS4DL+	N/A	0.9	DRS12A-NXT* (XN12A)	0.2	1.9
DRS6A X-Class* (XN12A)	N/A	2.2	DRS12A-NXT* (XN13A)	0.15	1.8
DRS6A X-Class* (XN13A)	N/A	1.9	DRS25A-NXT* (XN12A)	0.3	2.8
DRS12A X-Class* (XN12A)	0.3	3.1	DRS25A-NXT* (XN13A)	0.2	2.65
DRS12A X-Class* (XN13A)	0.2	2.9	DRS4D X-Class	0.53	1.7
DRS25A X-Class* (XN12A)	0.8	7.7	DRS4DL X-Class	N/A	0.73
DRS25A X-Class* (XN13A)	0.7	6.8			









*: Not compatible with the TZMAP9/13.







 **Check that no person is near the open-type radar antenna before you turn on the radar.**
Serious injury or death can occur if a person is hit by a rotating radar antenna.

 **Turn off the power immediately at the switchboard if water, metallic object or other foreign matter gets inside the equipment.**
Failure to turn off the equipment can cause fire or electrical shock.

 **Do not open the equipment.**
Only qualified service technicians are permitted to work inside the equipment.

 **The front panel of the display unit is made of glass. Handle it with care.**
Injury can result if the glass breaks.

 WARNING	
	<p>Keep the display unit away from areas subject to rain or water splash.</p> <p>Fire or electrical shock can occur if water gets inside the equipment.</p>
	<p>Do not disassemble or modify the equipment.</p> <p>Fire or electrical shock can occur if the equipment is disassembled or modified.</p>
	<p>Do not operate the equipment with wet hands.</p> <p>Electrical shock can occur.</p>
	<p>Use the correct fuse.</p> <p>A wrong fuse can cause fire or serious damage to the equipment.</p>
	<p>Do not rely solely on depth indication when navigating.</p> <p>Grounding can result.</p>
	<p>This equipment provides various information useful for navigation. However, never rely solely on a single navigation method, for safety of vessel and crew. Use all available navigational equipment (radar, direction finder, etc.) and always maintain a vigilant watch while underway.</p>
	<p>Guard zone warnings help prevent collisions. However, their use does not exempt the navigator from following the relevant guidelines for preventing collision at sea.</p>
	<p>Do not leave any objects near the radar antenna.</p> <p>Fire, electrical shock or injury can result if something gets caught in the radar antenna.</p>

 CAUTION	
	<p>Do not insert or remove the microSD card while the power is on.</p> <p>The contents of the microSD card may be damaged.</p>
	<p>The fish finder picture is not refreshed when the picture advance setting is “OFF”.</p> <p>It is dangerous to maneuver the vessel while referring to the depth indication in this condition.</p>
	<p>Do not use high-pressure cleaners to clean this equipment.</p> <p>This equipment has the waterproof rating outlined in the specifications, at the back of this manual. However, the use of high-pressure cleaning equipment can cause water ingress, resulting in damage to, or failure of, the equipment.</p>
	<p>Be sure to attach caps to all unused connectors.</p> <p>The unit may be damaged. Electrical shock can result.</p>
	<p>Do not connect/disconnect the cables connected to the unit while the power is turned on.</p> <p>The unit may be damaged.</p>

WARNING

The ARPA function is a valuable aid to navigation. However, the navigator must check all aids available to avoid collision.

- The ARPA automatically tracks an automatically or manually acquired radar target and calculates its course and speed, indicating them with a vector. Since the data generated by the ARPA depends on the selected radar targets, the radar must be optimally tuned for use with the ARPA, to ensure required targets will not be lost or unnecessary targets, like sea returns and noise, will not be acquired and tracked.
- A target is not always a landmass, reef, ship, but can also be returns from the sea surface and from clutter. As the level of clutter changes with the environment, the operator must correctly adjust the sea and rain clutter controls and the gain control so that the target echoes do not disappear from the radar screen.

CAUTION

The plotting accuracy and response of this ARPA meets IMO standards. Tracking accuracy is affected by the following:

- Tracking accuracy is affected by course change. One to two minutes is required to restore vectors to full accuracy after an abrupt course change. (The actual amount depends on gyrocompass specifications.)
- The amount of tracking delay is inversely proportional to the relative speed of the target. Delay is approx. 15-30 seconds for the higher relative speed; approx. 30-60 seconds for the lower relative speed. The following factors can affect accuracy:
 - Echo intensity
 - Radar transmission pulse length
 - Radar bearing error
 - Gyrocompass error
 - Course change (own ship and targets)

About the TFT LCD

The TFT LCD is constructed using the latest LCD technology, and displays 99.99% of its pixels. The remaining 0.01% of the pixels may drop out or be constantly lit. Additionally, the LCD has a limited viewing angle and may flicker. However these are not indications of malfunction.

TABLE OF CONTENTS

FOREWORD	xvii
SYSTEM CONFIGURATION	xx
1. SYSTEM INTRODUCTION	1-1
1.1 Controls, Touch Screen Operations	1-1
1.2 Remote Control Units (option).....	1-4
1.2.1 MCU-005.....	1-4
1.2.2 MCU-006, MCU-006H.....	1-6
1.2.3 Remote Control Unit group settings	1-7
1.3 How to Turn the Power On or Off.....	1-9
1.3.1 How to turn the power on	1-9
1.3.2 How to turn the power off	1-11
1.3.3 How to turn the power off remotely (TZT9E/13E only).....	1-11
1.4 How to Adjust the Brilliance and Hue of the Display	1-12
1.5 Home Page	1-13
1.6 How to Select a Display	1-15
1.6.1 How to select a display from the Home page.....	1-15
1.6.2 How to select a display from the Quick page	1-15
1.7 How to Edit the Display Icons	1-16
1.7.1 How to add a new display icon.....	1-17
1.7.2 How to edit a display icon	1-18
1.8 Edge Swipe Functions	1-18
1.9 Data Window.....	1-21
1.9.1 How to change the order of the data boxes	1-22
1.9.2 How to change the contents of a Data window	1-22
1.9.3 How to add a data box to a Data window.....	1-24
1.9.4 How to delete a data box	1-25
1.9.5 How to change the display method for the data in a Data window	1-25
1.9.6 How to adjust the transparency of the Data window	1-25
1.9.7 How to display 3-axis speed from the SC-33/SCX-20	1-26
1.10 User Interface.....	1-26
1.11 How to Use Storage Media	1-27
1.11.1 USB flash memory	1-27
1.11.2 MicroSD cards.....	1-28
1.12 Chart Plotter Introduction	1-29
1.13 Fish Finder Introduction	1-31
1.14 Radar Introduction.....	1-32
1.15 Settings Menu	1-33
1.16 Two-Finger Tap Function	1-36
1.17 Event Icon (long) Tap Operation Function	1-37
1.18 Language	1-38
1.19 Man Overboard (MOB).....	1-38
1.20 Wireless LAN Settings	1-39
1.20.1 How to connect the existing LAN	1-40
1.20.2 How to create a local wireless network	1-41
1.21 How to Create and Login to Your My TimeZero™ Account.....	1-42
1.22 PIN Code Lock.....	1-44

2. CHART PLOTTER	2-1
2.1 Chart Plotter Layers Menu.....	2-1
2.2 Chart Type.....	2-2
2.3 Range Zoom In, Zoom Out.....	2-3
2.4 Orientation Mode.....	2-4
2.5 How to Move the Chart.....	2-4
2.6 The Vessel Icon.....	2-5
2.6.1 Description.....	2-5
2.6.2 How to show or hide the COG vector, heading line.....	2-5
2.6.3 COG vector length.....	2-5
2.6.4 Vessel icon orientation.....	2-6
2.7 How to Find Information Chart Object and Chart Information.....	2-7
2.7.1 Chart object information.....	2-7
2.7.2 Chart information.....	2-8
2.8 Smart Search Function.....	2-9
2.9 How to Find the Range and Bearing Between Two Locations.....	2-10
2.10 Multiple Chart Plotter Displays.....	2-11
2.11 TZ MAPS Settings.....	2-12
2.11.1 How to set chart display color theme.....	2-12
2.11.2 How to select chart style.....	2-12
2.11.3 How to select land features type.....	2-13
2.11.4 How to set object size.....	2-13
2.11.5 How to set safety depths.....	2-13
2.11.6 Control visibility of text and object information in vector charts.....	2-14
2.11.7 How to send the TZ MAPS feedback.....	2-16
2.12 Alarms.....	2-16
2.12.1 Cross Track Error alarm.....	2-17
2.12.2 Sea surface temperature alarm.....	2-18
2.12.3 Depth alarm.....	2-19
2.12.4 Speed alarm.....	2-19
2.12.5 Wind speed alarm.....	2-19
2.12.6 Anchor watch alarm.....	2-20
2.12.7 Low fuel alarm.....	2-21
2.12.8 Other Alarms menu items.....	2-22
2.12.9 Alarms list.....	2-22
2.13 Track.....	2-23
2.13.1 How to start, stop recording the track.....	2-23
2.13.2 How to show or hide the track display.....	2-23
2.13.3 Track recording interval.....	2-24
2.13.4 Track color.....	2-25
2.13.5 Track thickness.....	2-28
2.13.6 How to create a route with past track (follow track).....	2-28
2.13.7 How to create a route with track currently being recorded (track back).....	2-29
2.13.8 Tracks list.....	2-30
2.13.9 How to find the number of track points used.....	2-33
2.13.10 How to delete tracks.....	2-34
2.14 Chart Plotter Menu.....	2-36
2.15 NAVpilot Series Auto Pilot.....	2-38
2.15.1 How to enable use of the NAVpilot.....	2-38
2.15.2 How to show the NAVpilot control box in the Data window.....	2-39
2.15.3 How to change the steering mode.....	2-39
2.15.4 How to change the NAVpilot settings.....	2-42
2.16 Community Maps.....	2-42
2.16.1 How to activate, deactivate Community Maps.....	2-42
2.16.2 How to create a chart object.....	2-43
2.16.3 How to create a mooring.....	2-45

TABLE OF CONTENTS

2.16.4	How to set up display information for chart objects/mooring.....	2-47
2.16.5	How to edit chart object/mooring information.....	2-48
2.16.6	How to move a chart object/mooring.....	2-49
2.16.7	How to delete a chart object/mooring.....	2-49
2.16.8	How to undo a modification.....	2-49
2.16.9	How to display chart object/mooring information	2-50
2.17	TZ iBoat.....	2-51
2.18	TZ First Mate.....	2-52
2.19	Photos.....	2-53
2.20	Fleet Tracking	2-56
2.20.1	How to set up fleet tracking.....	2-56
2.20.2	How to show/hide fleet target (sister ship) symbols.....	2-56
2.20.3	How to show fleet target information.....	2-57
2.20.4	How to clear fleet target symbols temporarily from the screen	2-57
2.20.5	Fleet target list.....	2-58
2.20.6	How to put a fleet target at the center of the chart plotter display.....	2-60
2.20.7	How to share user objects.....	2-60
2.21	Fish-It.....	2-60
3.	3D DISPLAY, OVERLAYS.....	3-1
3.1	3D Display.....	3-1
3.1.1	How to activate the 3D display.....	3-2
3.1.2	How to make the 3D view clearer	3-3
3.2	Overlays.....	3-4
3.2.1	Depth shading overlay	3-4
3.2.2	Satellite photo overlay.....	3-6
3.2.3	Radar overlay.....	3-6
3.2.4	Sonar overlay (TZT9E/13E only).....	3-8
3.2.5	Tide heights overlay	3-8
3.2.6	Tidal currents overlay.....	3-10
3.2.7	How to show the ACCU-FISH icon on the overlay.....	3-12
4.	POINTS, BOUNDARIES	4-1
4.1	About Points & Event Marks	4-1
4.2	How to Enter Points, Event Marks	4-2
4.2.1	How to enter points (chart plotter and radar displays only).....	4-2
4.2.2	How to enter event marks	4-3
4.2.3	How to enter an event mark at a specific location.....	4-5
4.3	How to Display Point, Event Mark, Catch Information	4-5
4.4	How to Enter a Comment for an Event Mark	4-6
4.5	Default Point, Event Mark Settings	4-6
4.5.1	Default point settings.....	4-6
4.5.2	Default event mark settings.....	4-8
4.6	How to Find Number of Points Used.....	4-8
4.7	Points List.....	4-9
4.7.1	How to show the Points list, process points.....	4-9
4.8	How to Move Points	4-12
4.8.1	How to move on-screen points.....	4-12
4.8.2	How to move points using the Pop-up menu	4-12
4.8.3	How to move points from the Points list.....	4-12
4.9	How to Delete Points.....	4-13
4.9.1	How to delete on-screen points.....	4-13
4.9.2	How to delete points from the Points list.....	4-13
4.9.3	How to delete points collectively from the Points list.....	4-13
4.9.4	How to delete all points from the menu.....	4-14
4.10	How to Edit Points.....	4-14

4.10.1	How to edit on-screen points	4-14
4.10.2	How to edit points from the Points list	4-15
4.10.3	How to edit points collectively from the Points list	4-16
4.11	How to Move a Point to the Screen Center	4-17
4.12	How to Show or Hide All Points, Points Names	4-17
4.13	How to Set Point Naming Functions	4-17
4.14	How to Set Point Density	4-18
4.15	How to Set Point Filters	4-18
4.16	How to Go to a Point	4-19
4.16.1	How to go to an on-screen point	4-19
4.16.2	How to go to a position selected on screen	4-21
4.16.3	How to go to a point selected from the Points list	4-23
4.16.4	How to use the NAVpilot to steer to a point	4-24
4.16.5	How to display the point information for the active Goto point	4-24
4.17	How to Restart or Cancel Navigation to a Point	4-25
4.17.1	How to restart navigation to a point	4-25
4.17.2	How to cancel navigation to a point	4-26
4.18	Boundaries	4-26
4.18.1	How to create boundaries	4-26
4.18.2	How to show or hide all boundaries	4-28
4.18.3	How to set default boundary attributes	4-28
4.18.4	Boundaries list	4-29
4.18.5	How to edit boundaries	4-32
4.18.6	How to add a point to a boundary	4-34
4.18.7	How to move a point on a boundary	4-34
4.18.8	How to delete a point from a line or area boundary	4-34
4.18.9	How to set an alarm for a boundary	4-35
4.18.10	How to find the number of boundary points used	4-36
4.18.11	How to display a boundary at the screen center	4-36
4.18.12	How to delete boundaries	4-37
5.	ROUTES	5-1
5.1	What is a Route?	5-1
5.2	How to Create a Route	5-2
5.2.1	How to create a route by selecting positions	5-2
5.2.2	How to create a route with previously entered points	5-3
5.2.3	How to create a route from the Points list	5-4
5.2.4	How to create a route automatically using the AI routing feature	5-4
5.3	How to Edit a Route	5-6
5.3.1	How to insert a route point into a route	5-6
5.3.2	How to move a route point within a route	5-6
5.3.3	How to delete a point on a route	5-7
5.3.4	How to extend a route	5-7
5.4	Routes List	5-7
5.5	How to Find Number of Routes Created	5-13
5.6	How to Find a Route on the Chart	5-13
5.7	How to Delete a Route	5-14
5.7.1	How to delete a route on the screen	5-14
5.7.2	How to delete a route via the Routes list	5-14
5.7.3	How to delete routes collectively via the Routes list	5-14
5.7.4	How to delete all routes	5-15
5.8	How to Show or Hide All Routes	5-15
5.9	How to Set Route Density	5-15
5.10	How to Follow a Route	5-16
5.10.1	How to follow an on-screen route	5-16
5.10.2	How to follow a route selected from the Routes list	5-17

TABLE OF CONTENTS

5.10.3	How to start navigation from a route point	5-18
5.10.4	How to show the detailed information about a route	5-19
5.11	Operations Available When You Follow a Route	5-20
5.11.1	How to restart navigation	5-20
5.11.2	How to follow a route in the reverse direction	5-20
5.11.3	How to stop following a route	5-21
5.11.4	How to skip a point on a route	5-21
5.11.5	Waypoint switching mode	5-21
5.11.6	How to automatically zoom a route	5-22
5.11.7	XTE lines	5-22
5.11.8	Waypoint arrival notification	5-22
5.11.9	End of route notification	5-22
5.11.10	How continue navigation at end of route	5-23
5.11.11	Steering a route with the NAVpilot	5-23
5.12	Risk Visualizer™ (TZT9E/13E Only)	5-24
5.13	Avoidance Route (TZT9E/13E Only)	5-25
5.14	SAR Operations	5-27
5.15	Fuel Level Indicators	5-30
5.16	Laylines	5-30
5.16.1	How to enable the layline feature	5-30
5.16.2	How to show layline data in the Data window	5-31
5.16.3	How to change the polar wind file	5-31
5.17	Routes Menu	5-32
6.	FISH FINDER	6-1
6.1	Fish Finder Layers Menu	6-1
6.2	How the Fish Finder Operates	6-2
6.3	How to Start, Stop Transmission	6-2
6.4	How to Select a Display	6-2
6.4.1	Single frequency display	6-2
6.4.2	Dual frequency display	6-3
6.4.3	Zoom displays	6-4
6.4.4	A-scope display (monitoring only)	6-6
6.4.5	Bottom discrimination display	6-6
6.5	How to Select the Range	6-8
6.6	How to Adjust the Gain	6-8
6.6.1	Automatic gain adjustment	6-8
6.6.2	Manual gain adjustment	6-9
6.7	How to Reduce Clutter	6-10
6.8	Picture Advance Speed	6-11
6.9	How to Reduce Interference	6-12
6.10	How to Erase Unnecessary Echoes	6-12
6.11	How to Measure Range, Depth to an Object	6-13
6.12	Echo History Display	6-13
6.13	How to Balance Echo Strength	6-14
6.14	Fish Finder Alarms	6-15
6.14.1	How to set an alarm	6-15
6.14.2	How to activate or deactivate an alarm	6-16
6.14.3	Alarm sensitivity	6-16
6.14.4	Reset the fish alarm menus to default	6-16
6.15	ACCU-FISH™	6-16
6.15.1	How to set ACCU-FISH™	6-17
6.15.2	Fish size correction	6-18
6.15.3	How to turn the fish symbol indication on or off	6-18
6.15.4	How to display the fish information	6-18
6.15.5	How to set the minimum size of ACCU-FISH™ symbols	6-18

6.16 RezBoost™ (TZT9E/13E Only).....	6-19
6.17 White Edge	6-19
6.18 Water Temperature Graph	6-20
6.19 Preset Frequency	6-21
6.20 Color Range Expansion.....	6-22
6.21 Fish Finder Menu	6-23
6.22 How to Interpret the Display	6-27
7. RADAR	7-1
7.1 Layers Menu.....	7-1
7.2 How to Transmit, Set the Radar in Stand-by	7-2
7.3 Tuning.....	7-4
7.4 How to Adjust the Gain.....	7-4
7.5 How to Reduce the Sea Clutter.....	7-6
7.6 How to Reduce the Rain Clutter	7-7
7.7 Range Scale	7-7
7.8 Orientation Mode	7-7
7.9 How to Measure the Range and Bearing from Your Ship to a Target	7-8
7.9.1 How to display the range rings	7-8
7.9.2 How to set the number of the range rings to show	7-9
7.9.3 How to select the range rings mode	7-9
7.9.4 How to measure the range and bearing to an object	7-10
7.9.5 How to measure the range with the VRM.....	7-11
7.9.6 How to measure the bearing with the EBL	7-13
7.9.7 How to select the EBL reference	7-14
7.10 How to Measure the Range and Bearing Between Two Targets	7-15
7.11 How to Off-center the Picture	7-15
7.12 Heading Line	7-16
7.13 How to Reduce Radar Interference	7-16
7.14 Echo Average	7-17
7.15 Guard Zone	7-17
7.15.1 How to set a guard zone	7-17
7.15.2 How to activate or deactivate a guard zone	7-18
7.15.3 How to hide a guard zone	7-18
7.16 Watchman	7-19
7.17 Echo Trail	7-19
7.17.1 How to show or hide echo trails	7-20
7.17.2 How to clear echo trails	7-20
7.17.3 How to select echo trail length	7-20
7.17.4 How to select the echo trail mode (reference).....	7-20
7.17.5 How to select echo trail color	7-21
7.17.6 How to select echo trail shading.....	7-21
7.17.7 How to reset Trail menu items to default.....	7-22
7.18 How to Show or Hide or Cancel an Active Route	7-23
7.19 How to Show or Hide the Own Ship Icon	7-23
7.20 Echo Color.....	7-23
7.21 Background Color.....	7-24
7.22 Dual-Range Display.....	7-25
7.23 Bird Mode	7-26
7.24 Target Analyzer™	7-27
7.25 RezBoost™	7-29
7.26 ARPA Operation	7-31
7.26.1 How to show or hide the ARPA display.....	7-31
7.26.2 How to manually acquire a target.....	7-32
7.26.3 How to automatically acquire a target	7-32
7.26.4 How to automatically acquire targets by Doppler	7-33

TABLE OF CONTENTS

7.26.5	Full auto tracking (TZT9E/13E only)	7-33
7.26.6	How to display target data	7-35
7.26.7	How to stop tracking targets	7-35
7.26.8	ARPA list	7-36
7.26.9	How to clear lost targets	7-38
7.26.10	CPA/TCPA alarm	7-38
7.26.11	CPA graphic display	7-39
7.26.12	Risk Visualizer™ (TZT9E/13E only)	7-39
7.27	Connecting With FAR-2xx7/FAR-2xx8/FAR-15x3/FAR-15x8 Series Radars (TZT9E/13E Only)	7-40
7.28	Radar Menu	7-41
7.29	How to Interpret the Radar Display	7-43
7.29.1	False echoes	7-43
7.29.2	Search and rescue transponder (SART)	7-45
7.29.3	RACON (Radar Beacon)	7-45
8.	CHIRP SIDE SCAN	8-1
8.1	CHIRP Side Scan Display	8-1
8.2	CHIRP Side Scan Menu	8-2
8.3	How To Start, Stop Transmission	8-3
8.4	How to Change the TX Rate	8-3
8.5	How to Change the Echo Color	8-4
8.6	How to Change the Range	8-4
8.7	How to Adjust the Gain	8-4
8.8	Depth/Water Temperature/Gain Display	8-5
8.9	How to Change the Picture Advance Speed	8-5
9.	MULTI BEAM SONAR DFF-3D (FOR TXT9E/13E ONLY)	9-1
9.1	Menu Operations	9-1
9.1.1	How to start/stop transmission	9-1
9.1.2	How set the background color	9-1
9.1.3	How to adjust the bottom range shift	9-2
9.1.4	How to change the TX rate	9-2
9.2	Display Screens Overview	9-3
9.3	Multi-Sounder Display Operations	9-6
9.3.1	How to switch between TX and STBY	9-6
9.3.2	How to switch between single beam and triple beam presentations	9-6
9.3.3	How to set the TX beam angle	9-6
9.3.4	How to set the TX beam width	9-7
9.3.5	How to change the picture advance speed	9-7
9.3.6	How to change the display mode	9-7
9.3.7	How to show or hide the depth/water temperature/gain/ frequency indications	9-7
9.3.8	Fish alarm	9-8
9.3.9	How to manually adjust the gain	9-8
9.3.10	Availability of points and event marks registration, and go to a point	9-8
9.3.11	How to reset the Multi-Sounder menu settings to default	9-9
9.4	Side Scan Display Operations	9-9
9.4.1	How to switch between TX and STBY	9-9
9.4.2	How to change echo color	9-9
9.4.3	How to change the range	9-9
9.4.4	How to change the picture advance speed	9-10
9.4.5	How to show or hide the depth/water temperature/gain/ frequency indications	9-10
9.4.6	How to manually adjust the gain	9-10
9.4.7	Availability of points and event marks registration, and go to a point	9-11

9.4.8	How to reset the Side Scan menu settings to default.....	9-11
9.5	Cross Section Display Operations.....	9-12
9.5.1	How to switch between TX and STBY.....	9-12
9.5.2	How to show or hide the grid.....	9-12
9.5.3	Zoom display.....	9-12
9.5.4	How to smooth echoes (distance).....	9-13
9.5.5	How to smooth echoes (time).....	9-13
9.5.6	How to apply correction to the speed of sound.....	9-13
9.5.7	How to show or hide the depth/water temperature/gain/ frequency indications.....	9-13
9.5.8	How to manually adjust the gain.....	9-14
9.5.9	Availability of points and event marks registration, and go to a point.....	9-14
9.5.10	How to reset the Cross Section menu settings to default.....	9-14
10.	CSH-10 SCANNING SONAR (TZT9E/13E ONLY).....	10-1
10.1	Sonar Display.....	10-1
10.2	Sonar Menu.....	10-2
10.3	How to Protrude and Retract the Transducer.....	10-4
10.4	How to Switch to Transmission/Standby State.....	10-5
10.5	How to Adjust the Gain.....	10-5
10.6	How to Adjust Near Gain/Far Gain.....	10-6
10.7	How to Suppress Bottom Tail.....	10-6
10.7.1	How to set AGC near/far.....	10-6
10.7.2	How to set pulse length.....	10-7
10.7.3	How to suppress the unwanted echoes.....	10-7
10.8	How to Set the Transmission Power.....	10-8
10.9	How to Reject Sonar Interference and Noise.....	10-8
10.9.1	How to reject noise with the interference rejector.....	10-8
10.9.2	How to reject noise with the noise limiter.....	10-9
10.9.3	How to set the transmission interval.....	10-10
10.9.4	How to shift the transmission frequency.....	10-11
10.9.5	How to adjust echo average.....	10-11
10.10	How to Adjust Beamwidth.....	10-12
10.11	How to Remove Weak Echoes.....	10-12
10.12	How to Set Smooth Echo.....	10-13
10.13	Tilt Angle.....	10-13
10.13.1	How to set the tilt angle.....	10-13
10.13.2	How to turn automatic tilt on/off.....	10-13
10.14	How to Adjust the Heading Line.....	10-14
10.15	Background Color.....	10-14
10.16	How to Restore Scan Settings (Range, Tilt Angle, Gain).....	10-14
10.16.1	How to restore the settings for scanning.....	10-15
10.17	Program Settings.....	10-15
10.17.1	How to register preset setting.....	10-15
10.17.2	How to recall program settings.....	10-16
10.18	Display On/Off Settings.....	10-16
10.19	Sonar Event Mark.....	10-16
10.19.1	How to register an event mark.....	10-16
10.19.2	How to show sonar event marks in the data box.....	10-17
10.19.3	How to delete event marks.....	10-17
10.20	How to Navigate Points.....	10-17
10.21	Fish-It Selection.....	10-17

11. FILE OPERATIONS	11-1
11.1 Files Menu.....	11-2
11.2 How to Set the Export Format.....	11-2
11.3 How to Export User Objects.....	11-3
11.4 How to Import User Objects.....	11-3
11.5 How to Export Tracks.....	11-3
11.6 How to Import Tracks.....	11-4
11.7 How to Export Equipment Settings	11-4
11.8 How to Import Equipment Settings.....	11-4
11.9 My TIMEZERO Cloud Data Service.....	11-5
11.9.1 How to export data to the cloud	11-5
11.9.2 How to restore data from the cloud.....	11-5
11.10 How to Convert NavNet vx2 Data.....	11-5
12. FUSION-Link.....	12-1
12.1 FUSION Display.....	12-1
12.2 FUSION Operation Bar	12-2
12.3 FUSION Settings.....	12-3
13. INSTRUMENT DISPLAYS	13-1
13.1 How to Show the Instrument Display	13-1
13.2 Instrument Displays.....	13-2
13.2.1 Full-screen instrument displays.....	13-2
13.2.2 Split screen instrument display	13-4
13.2.3 How to switch between instrument displays.....	13-7
13.2.4 How to pin instrument screens.....	13-7
13.3 How to Edit the Instrument Displays	13-8
13.3.1 How to prepare for editing.....	13-8
13.3.2 How to rearrange the indications in an instrument display.....	13-8
13.3.3 How to edit, remove an indication in an instrument display	13-9
13.3.4 How to add an indication to an instrument display.....	13-11
13.3.5 How to rename an instrument display.....	13-12
13.3.6 How to remove an instrument display.....	13-12
13.3.7 How to add an instrument display	13-12
13.3.8 SC-33/SCX-20 3-axis speed display.....	13-13
13.4 Instrument Theme, Instrument Background.....	13-13
13.5 Fuel Management System	13-14
13.5.1 How to manually enter fuel tank capacity.....	13-14
13.5.2 How to check remaining fuel amount.....	13-14
13.6 CZone	13-15
13.6.1 How to use CZone	13-15
13.6.2 CZone control.....	13-16
13.6.3 CZone modes.....	13-17
13.6.4 CZone monitoring.....	13-19
13.7 SUZUKI Engine Function	13-21
13.7.1 SUZUKI engine instrument display examples.....	13-21
13.7.2 Troll mode	13-26
13.7.3 Auto trim.....	13-27
13.7.4 Keyless.....	13-27
13.7.5 Quick Response (QR) code	13-28
13.7.6 Reset data.....	13-30
13.7.7 Device list.....	13-30
13.7.8 SUZUKI engine alarms	13-31

14. WEATHER OPERATIONS	14-1
14.1 Weather Display Introduction	14-1
14.2 Weather Display Layers Menu	14-2
14.3 TZ Weather.....	14-3
14.3.1 How to set up for TZ weather	14-3
14.3.2 How to set the TZ weather download data size	14-4
14.3.3 How to download the TZ weather data.....	14-5
14.3.4 How to display the TZ weather data.....	14-6
14.4 Meteogram Display.....	14-8
14.5 SiriusXM Weather.....	14-9
14.5.1 SiriusXM weather Layers menu	14-10
14.5.2 How to set up for SiriusXM weather	14-11
14.5.3 How to display the SiriusXM weather data.....	14-12
14.6 Weather Icons (SiriusXM Weather).....	14-14
14.7 Weather Data (TZ Weather or SiriusXM Weather).....	14-14
14.8 SiriusXM Weather Diagnostics	14-18
14.9 SiriusXM Satellite Radio.....	14-18
14.9.1 How to activate the radio.....	14-18
14.9.2 How to operate the radio controls	14-19
14.9.3 Radio diagnostics	14-20
14.10 Fish Mapping	14-20
14.10.1 How to show the fish mapping display	14-21
14.10.2 Fish mapping features.....	14-22
14.10.3 How to show fish mapping data	14-27
14.10.4 How to change fish mapping settings.....	14-27
14.10.5 How to show or hide overlays	14-28
14.10.6 How to show or hide user objects	14-28
15. AIS, DSC MESSAGE	15-1
15.1 What is AIS?.....	15-1
15.2 How to Show or Hide the AIS Symbols	15-1
15.3 AIS Target Symbols.....	15-1
15.4 Proximity AIS Target Alarm	15-2
15.5 How to Ignore Slow Moving AIS Targets.....	15-3
15.6 How to Display AIS Safety Messages	15-3
15.7 How to Display AIS Target Data.....	15-4
15.8 How to Show or Hide the Target IDs	15-4
15.9 AIS List.....	15-5
15.10 AIS SART Display.....	15-7
15.11 CPA/TCPA Alarm	15-7
15.12 How to Register an AIS or DSC Target to the Buddies List.....	15-8
15.13 CPA Graphic Display	15-9
15.14 AIS Transponder FA-30, FA-50	15-10
15.15 DSC Message Information.....	15-11
15.15.1 DSC distress message.....	15-11
15.15.2 How to set a DSC marker as destination	15-11
15.15.3 How to display DSC marker information	15-12
15.15.4 The DSC list	15-12

TABLE OF CONTENTS

16. OTHER FUNCTIONS	16-1
16.1 General Menu	16-1
16.2 Units Menu	16-3
16.3 Initial Setup Menu	16-5
16.4 Facsimile Receiver FAX-30.....	16-10
16.5 How to Check, Update the Software	16-11
16.6 How to Manage Your Charts.....	16-14
16.6.1 How to update or add TZ MAPS charts	16-14
16.6.2 How to update TZ MAPS charts.....	16-16
16.6.3 How to display the MM3D charts catalog.....	16-18
16.6.4 How to add MM3D charts.....	16-19
16.6.5 How to delete MM3D charts.....	16-19
17. MAINTENANCE	17-1
17.1 Maintenance.....	17-1
17.2 Replacement of Parts.....	17-2
17.3 Troubleshooting	17-3
17.3.1 General troubleshooting.....	17-3
17.3.2 Chart plotter troubleshooting.....	17-3
17.3.3 Radar troubleshooting.....	17-4
17.3.4 Fish finder troubleshooting.....	17-4
APPX. 1 MENU TREE	AP-1
APPX. 2 TRANSDUCER LIST	AP-16
APPX. 3 ALERT MESSAGES	AP-18
APPX. 4 RADIO REGULATORY INFORMATION	AP-26
SPECIFICATIONS	SP-1
INDEX.....	IN-1

FOREWORD

A Word to the Owner

Congratulations on your choice of the TZMAP9/13 and TZT9E/13E Multi Function Display. We are confident you will see why the FURUNO name has become synonymous with quality and reliability.

Since 1948, FURUNO Electric Company has enjoyed an enviable reputation for innovative and dependable marine electronics equipment. This dedication to excellence is furthered by our extensive global network of agents and dealers.

Your equipment is designed and constructed to meet the rigorous demands of the marine environment. However, no machine can perform its intended function unless properly installed and maintained. Please carefully read and follow the operation and maintenance procedures set forth in this manual.

We would appreciate feedback from you, the end-user, about whether we are achieving our goal.

Thank you for considering and purchasing FURUNO.

Features

The TZMAP9/13 and TZT9E/13E, equipped with a touch screen with multi touch capacity, is a networked navigation system that gives you functions such as radar, chart plotter, fish finder, and AIS. Information is transferred between TZTMAP9/13 and TZT9E/13E units through Ethernet and/or NMEA 2000. The plug-and-play format allows expansion and you can connect a maximum of six TZT9E/13E units.

Note: The features that require network connection with other TZtouch devices are only available for the TZT9E/13E. Multiple TZMAP9/13s cannot be connected in the same network, neither can be connected to the TZT9E/13E devices.

Main features

- Intuitive touch control operation.
- Instrument display provides comprehensive navigation data with connection of appropriate sensors.
- The latest weather information can be downloaded via the Internet.
- Points (waypoints) and routes can be transferred and shared between TZT9E/13E units, via Ethernet.
- Large memory stores, 30,000 Points, 200 Routes, 100 Areas & Lines, 100 Circles, 1,000 Photos, 1,000 Catches, 100,000 Track Points.
- TZ MAPS chart licenses can be renewed and chart data downloaded online.
- TZ BathyVision displays detailed contour lines.
- Write and read data (points, routes, tracks, etc.) using a USB flash memory.
- Community maps feature lets users create and edit chart objects.
- Automatic route creation using TZ MAPS.
- AIS function (requires connection of AIS transponder) receives AIS data from AIS equipped vessels, shore stations and navigational aids and displays relevant data.

FOREWORD

- The fish finder functions described below are available.
 - ACCU-FISH™ provides at-a-glance estimation of length and depth of individual fish.
 - Bottom discrimination display helps identify probable bottom composition with graphics and colors.
 - CHIRP side scan provides high resolution, low-noise images of underwater conditions.
- Dual-range radar display available for watch on short and long distances at the same time.
- DSC (Digital Selective Calling) message information feature provides the MMSI no. and position of vessels that have transmitted a DSC message to you. (Requires DSC capable radiotelephone.)
- Control audio of FUSION-Link™ equipment.

Software used in this product

- Ubiquitous QuickBoot™ Copyright© Ubiquitous AI Corporation. All rights reserved.
- This product includes software to be licensed under the GNU General Public License (GPL) version 2.0, GNU Lesser General Public Software License (LGPL) version 2.0, Apache, BSD and others. The program(s) is/are free software(s), and you can copy it and/or redistribute it and/or modify it under the terms of the GPL version 2.0 or LGPL version 2.0 as published by the Free Software Foundation. Please access to the following URL if you need source codes: https://www.furuno.co.jp/contact/cnt_oss01.html.

Program no.

TZMAP9/13:

1950257-XX.XX

TZT9E/13E:

1950259-XX.XX

“XX” denotes software version number.

CE/UKCA declaration

With regards to CE/UKCA declarations, please refer to our website (www.furuno.com), for further information about RoHS conformity declarations.

Disclosure of information about China RoHS

With regards to China RoHS information for our products, please refer to our website (www.furuno.com).

Standards used in this manual

- Key names are shown in boldface type. For example, **CURS** key (on the MCU-005/006/006H).
- Menu items, on-screen indications, and the names of Pop-up menus are shown in brackets. For example, the [Settings] menu.
- Messages shown on the screen (including the Status bar) are enclosed in quotations. For example, "No Network Connected".

- The [Settings] menu is comprised of several sub menus. When you are asked to select one of its sub menus, [Settings] is followed by an arrow and the sub menu name. For example, “[Settings]→[General]”.
- The colors mentioned in this manual are the default colors. Your colors may be different.
- The screenshots shown in this manual are taken from the TZT9E/13E. The screens you see may be slightly different on your display, depending on your system configuration and equipment settings.

Security considerations

Keep in mind the following security considerations when using this equipment.

- To prevent accidental or unauthorized operation, unauthorized use of the product, and leakage of information, it is recommended to use the password function (including PCs and smart devices that can be connected to this device).
- Be aware of scam calls from a third party that asks you for your TeamViewer access code to prevent a risk of unauthorized access to your TeamViewer remotely. FURUNO never calls the user directly.

SYSTEM CONFIGURATION

TZMAP9/13

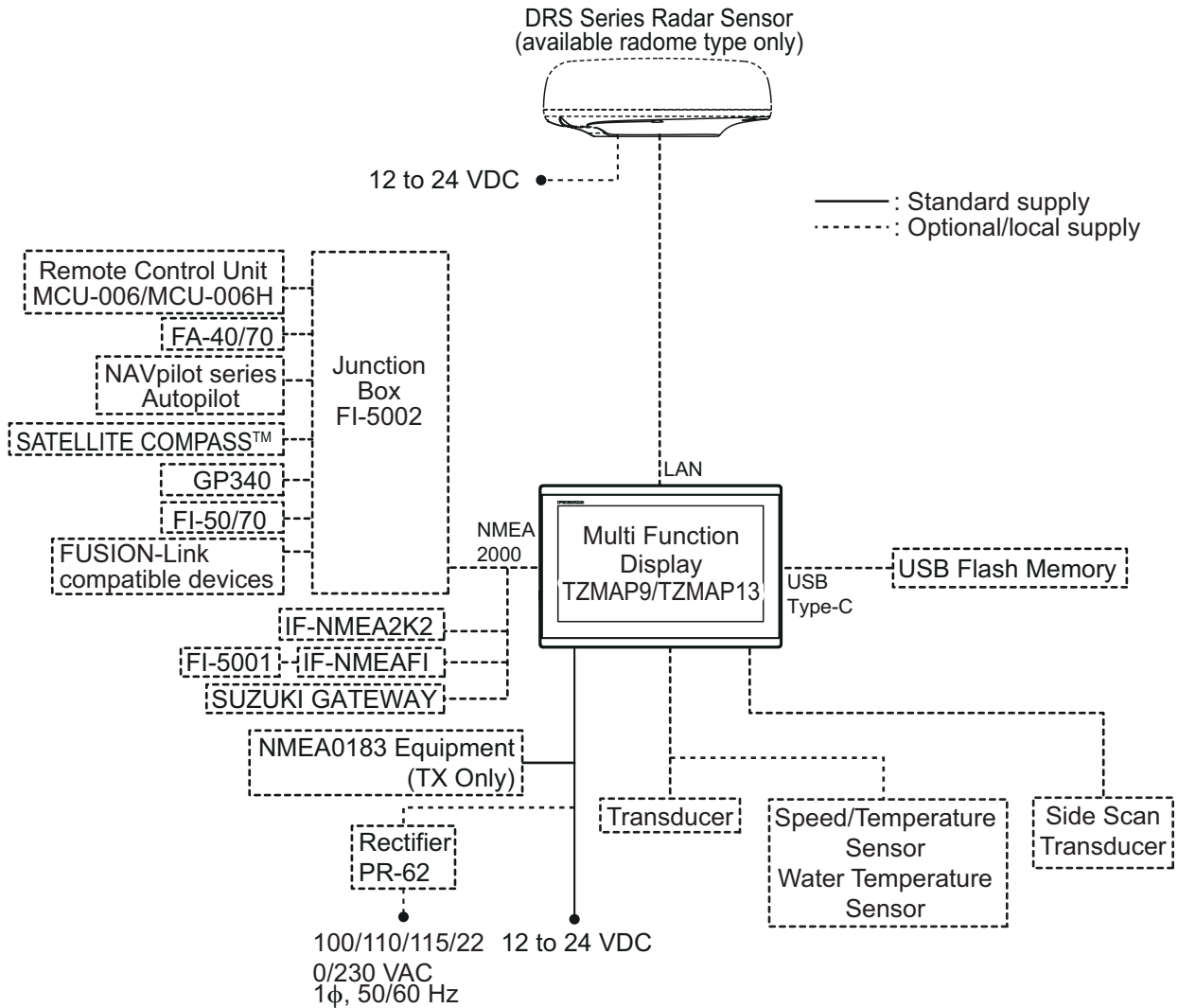

Category of units

Antenna unit: Exposed to the weather.

Other units: Protected from the weather.

TZT9E/13E

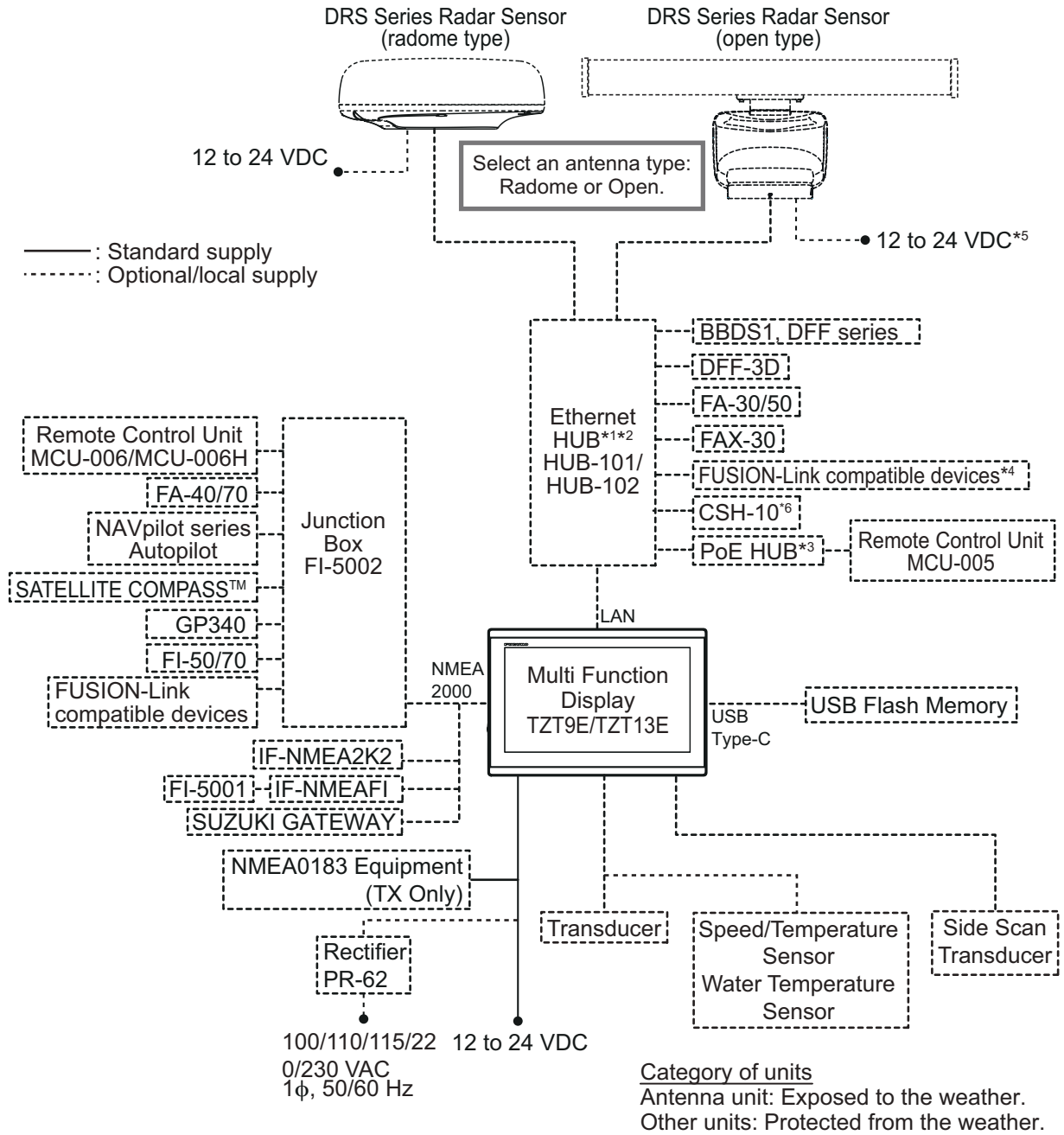

- *1: For the multi-stage (cascade) connection, a maximum of four units of HUB-101/HUB-102 can be connected to the MFDs.
- *2: With the Ethernet HUB, up to six NavNet TZtouch series units can be connected (up to four units when the TZT2BB is included). NavNet TZtouch (TZT9/14/BB) and TZTL12F/15F of NavNet TZtouch2 cannot be connected. For connection combinations, see “TZT series network connections” at the end of this chapter for details.
- *3: Use a commercially available PoE HUB. The NETGEAR GS108PE has tested as compatible. The basic functions of the hub were verified, however the compatibility of all functions were not checked. FURUNO cannot guarantee proper operation.
- *4: Available when FUSION-Link compatible equipment is connected via Ethernet.
- *5: 12 VDC is only used with DRS6A-NXT. All other open array DRS sensors require 24 VDC.
- *6: The software version of the CSH-10 must be “Ver. 01.02” or later.

TZT series network connections

The TZT series can be connected on the same network in the following combinations.

	TZtouch: TZT9/14/ BB	TZtouch2: TZTL12F/15F	TZtouch2: TZT2BB^{*1}	TZtouch3: TZT9F/12F/16F/ 19F^{*2}	TZtouch XL: TZT10X/13X/16X/ 22X/24X/BBX^{*3}
TZtouchE: TZT9E/13E	No	No	Yes	Yes	Yes

^{*1}: Available in the future (from version 9.9).

^{*2}: Available in the future (from version 3.9).

^{*3}: Available in the future (from version 26.11).

1. SYSTEM INTRODUCTION

1.1 Controls, Touch Screen Operations

This multi function display unit can be operated by its touch screen, or using the optional remote control.

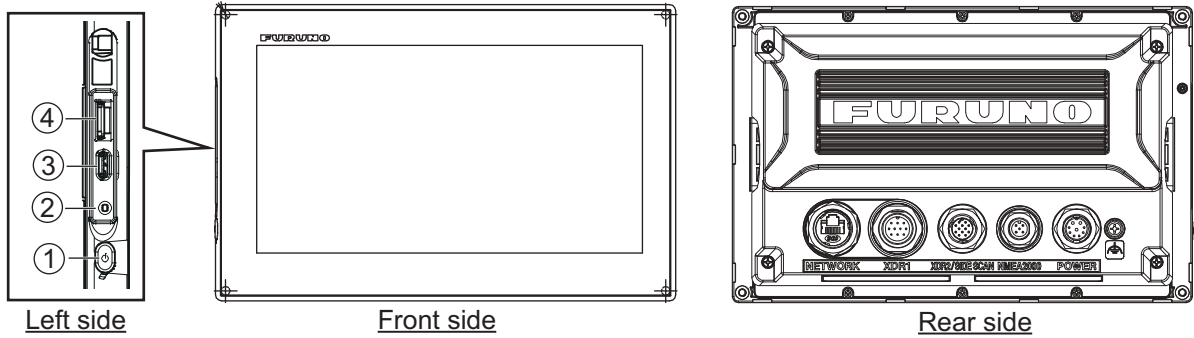

No.	Item	Function
1	Power button	Turns the power on. Tapping the switch with the unit powered displays the [Quick Access] window. [Quick Access] window <ul style="list-style-type: none"> • Toggles radar, fish finder, multi beam sonar and NAVpilot between transmit and stand-by. • Adjusts the display brilliance and hue. • Turns the power off (device or other devices on the network (for TZT9E/13E only)). • Locks, unlocks the touch screen.
2	Reset button	Press reset button to force the system shutdown. Use this if the program or window freezes, etc.
3	USB port (Type-C)	Connects a USB flash memory (Type-C).
4	Micro SD card slot	Port for chart cards

How to attach, detach the sun cover

The sun cover protects the LCD when the display unit is not in use. To remove the cover, grasp the cover at the locations circled in the figure below and pull forward.

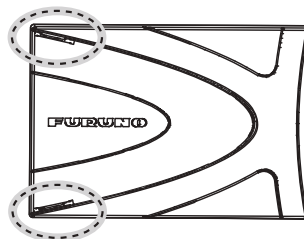

1. SYSTEM INTRODUCTION

Touch screen operations

The tables shown below outline the available touch screen operations.

Operations with a finger

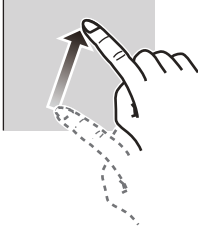
Operation with a finger		Function
Tap		<ul style="list-style-type: none"> • Selects a menu item. • Selects an object or position to display the applicable Pop-up menu.
Long tap		<ul style="list-style-type: none"> • Edits display icon (on Home page).
Drag		<ul style="list-style-type: none"> • Pans the charts. Note: The drag speed can be adjusted from the [Pan Speed] menu (see section 16.1). • Scrolls the menu.
Swipe		<ul style="list-style-type: none"> • Shows the Slide-out menu, Layers menu. See section 1.8.

Operations with two fingers

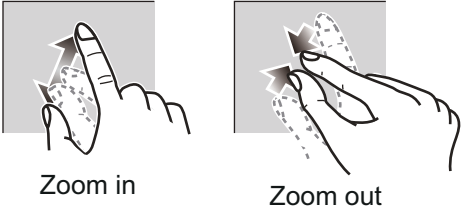
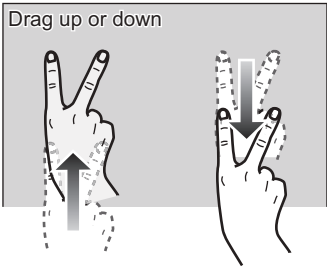
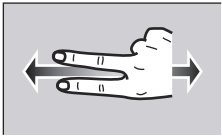
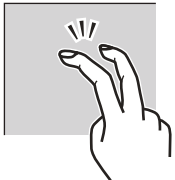
Operation with two fingers		Function
Pinch	 <p>Zoom in Zoom out</p>	<ul style="list-style-type: none"> • Zooms in or out the display range in the 2D/3D modes or weather display. Note: The pinch speed can be adjusted from the [Pinch Speed] menu (see section 16.1). • Selects range for the radar and fish finder displays.
Drag	 <p>Drag up or down</p>	<p>Up: Switches from 2D display to 3D display. Down: Switches from 3D display to 2D display.</p>
		Changes 3D viewing point.
Tap		Does the function assigned to [Two Finger Tap Function], or [Two Finger Long Tap Function]. Setting method: Home page→[Settings]→[General]→[This Display]→[Two Finger Tap Function]/[Two Finger Long Tap Function]. See section 1.16.
Long Tap		

Notes on touch screen operations

- Waterdrops on the screen can cause mis-operation and slow touch response. Wipe the screen with a dry cloth to remove the water.
- This equipment uses a capacitive touch screen. Tap the screen with your fingertips directly. Do not use sharp objects (needle, pen, nail) or a stylus pen. Be careful not to scratch the screen.
- Touch screen sensitivity may be reduced when wearing gloves.
- Do not put objects (adhesive-backed paper, etc.) on the screen. Mis-operation can result.
- Keep the equipment away from radio antennas, fluorescent lights, solenoid valves and electronic devices, to prevent unintended operation caused by electrical noise.
- The front panel is made of glass. If the front panel is damaged, do not try to repair it yourself. Unauthorized repair will void the warranty. Contact your dealer about repair or replacement.

How to lock the touch screen

The touch screen can be locked to prevent operation. With the power applied, press the power button to show the [Quick Access] window. Tap the [Touch Screen] icon to lock or unlock the touch screen.

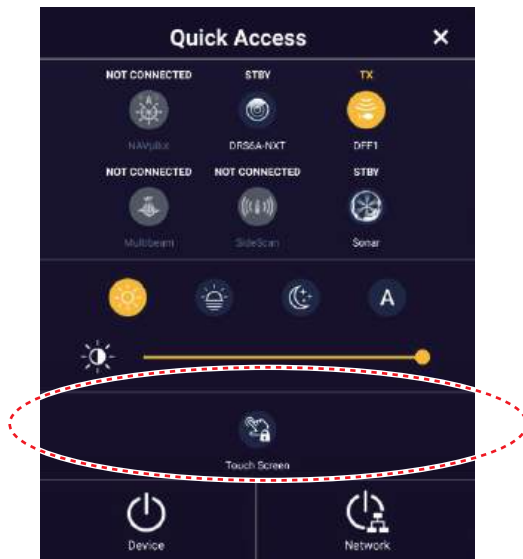

When the screen is locked, a small padlock-shaped icon appears on the [FURUNO] icon (top-left of the screen), as shown in the figure below.



1.2 Remote Control Units (option)











The Remote Control Units let you operate the system without touching the screen. When the power is applied and a Remote Control Unit is connected, an orange cursor (selection cursor) marks current selection in menus.

Note: When the Remote Control Unit is connected, a frame is displayed in the four corners of the screen to indicate that the remote control is performed.

1.2.1 MCU-005

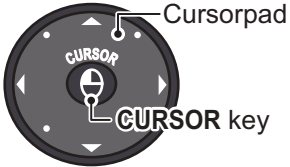
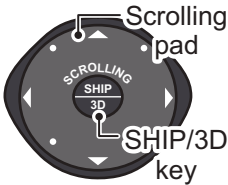

No.	Key, control	Description
1	Power lamp	When the power is applied to the MCU-005, the lamp is lit.
2	EVENT key	<ul style="list-style-type: none"> • Short push: Registers current position as event mark 1. • Long push: Registers current position as event mark 2. The event mark 1 and event mark 2 are registered in the symbol and color selected with [Default Event Mark 1(2) Symbol] and [Default Event Mark 1(2) Color] in the [Points & Boundaries] menu.
3	GAIN/TX key	<ul style="list-style-type: none"> • Short push: Adjusts the radar gain/AC SEA/AC RAIN, fish finder/multi-beam sounder gain. • Long push: Toggles between standby and transmit for the radar/fish finder/multi-beam sonar.
4	MENU key	Opens/closes the menu.
5	HOME/BRILL key	<ul style="list-style-type: none"> • Short push: Opens the Home page. • Long push: Opens the [Quick Access] window
6	CANCEL/MOB key	Short push: <ul style="list-style-type: none"> • Closes menus/windows. • Stops the aural alarm. • Ends the tool mode ([End Route], [End Move], etc.). Long push: <ul style="list-style-type: none"> • Enters the MOB mark (at the own ship's position).
7	CTRL key	Switches control between multiple displays when more than one display is in the system (TZT9E/13E only).

No.	Key, control	Description
8	 <p>(EDGE key)</p>	<ul style="list-style-type: none"> • Activates the selected item. • Press the  key, then operate the CursorPad or scroll pad to open Layers menu, Quick page, Slide-out menu, Data window. <p>• Opens Layers menu • Opens Quick page</p> <p> Push  Tap  Push  Tap</p> <p>• Opens Slide-out menu • Opens Data window</p> <p> Push  Tap  Push  Tap</p>
9	<p>FUNC key</p>	<ul style="list-style-type: none"> • Short push: Performs the function assigned to two finger tap function. • Long push: Performs the function assigned to two finger long tap function.
10	<p>CURSOR key and Cursorpad</p> 	<p>CURSOR key: short push</p> <ul style="list-style-type: none"> • Opens pop up menus. • Activates/confirms the item selected by the cursor. <p>CURSOR key, long push:</p> <ul style="list-style-type: none"> • Edit display icon (on Home page). <p>Cursorpad operation:</p> <ul style="list-style-type: none"> • Moves the selection cursor.
11	<p>STBY/AUTO key</p>	<p>Switches the steering mode of the FURUNO NAVpilot series Autopilot between the STBY (Stand-by) and AUTO modes. When switching occurs, a beep* sounds and a message informs you of Navpilot mode change.</p> <ul style="list-style-type: none"> • STBY mode→AUTO mode: "Navpilot Engaged". • AUTO mode→STBY mode: "Navpilot Disengaged". <p>*: The beep sound can be turned on or off with [Alarm Sound when NAVpilot is engaged]. See page 2-22.</p>
12	<p>POINTS/ROUTE key</p>	<p>Short push: Sets the cursor location as a point. Long push: Starts a route from the cursor location.</p>
13	<p>RotoKey™</p>	<p>Short push:</p> <ul style="list-style-type: none"> • Opens pop up menus. • Activates/confirms the item selected by the cursor. <p>Long push:</p> <ul style="list-style-type: none"> • Edit display icon (on Home page). <p>Rotate:</p> <ul style="list-style-type: none"> • Moves the selection cursor. Selected items are highlighted. • Zooms the display in/out.
14	<p>RANGE OUT/IN key</p>	<ul style="list-style-type: none"> • Zooms the display in/out.
15	<p>SHIP/3D key and Scrolling pad</p> 	<p>SHIP/3D key, short push:</p> <ul style="list-style-type: none"> • Returns own ship to center of screen (Chart Plotter/Weather/Radar display). • Cancels the echo history (Fish finder display). <p>SHIP/3D key, long push:</p> <ul style="list-style-type: none"> • Switches between 2D and 3D display. <p>Scrolling pad:</p> <ul style="list-style-type: none"> • Scrolls chart, radar picture.

1.2.2 MCU-006, MCU-006H



MCU-006



MCU-006H

No.	Key, control	Description
1	Home/Setting key	<ul style="list-style-type: none"> • Short push: Goes to the Home page. • Long push: Opens the Settings menu.
2	Event/GOTO key	<ul style="list-style-type: none"> • Short push: Creates an event mark* at the current position. • Long push: Go to the cursor-selected point. <p>*: Default event mark shape and color are set with [Default Event Mark 1 Symbol] and [Default Event Mark 1 Color], in the [Points & Boundaries] menu.</p>
3	Joystick/Roto key	<p>Push: Confirms selection of item by cursor.</p> <p>Joystick:</p> <ul style="list-style-type: none"> • Moves the cursor in the cursor mode. • Scrolls the screen in the scroll mode. <p>Roto key:</p> <ul style="list-style-type: none"> • Selects items on menus. • Zooms the display in, out. • Increments, decrements numerical display.
4	CURS/SCRL key	Switches between cursor shift, screen scroll.
5	CANCEL/MOB key	<p>Short push</p> <ul style="list-style-type: none"> • Closes menu, window. • Goes back one layer in menu. • Ends the tool mode ([End Route], [End Move], etc.). <p>• Long push: Inscribes a MOB mark at the current position.</p>
6	CTRL/Full Screen key	<ul style="list-style-type: none"> • Short push: Switches the active screen. • Long push: Switches the active screen between full screen, divided screen.
7	EDGE Swipe/Switch MFD to Control key	<ul style="list-style-type: none"> • Short push: Enables edge swipe operation with the joystick. • Long push: Switches the MFD to operate.
8	NAV INFO/F1 (short) key	<ul style="list-style-type: none"> • Short push: Opens the NAV INFO window. • Long push: Performs the function gesture assigned to the “two finger tap function.”

No.	Key, control	Description
9	GAIN/F2 (long) key	<ul style="list-style-type: none"> • Short push: Enables gain setting with the Roto key. • Long push: Performs the function gesture assigned to the “two finger long tap function.”
10	AUTO/STBY key	<p>Switches autopilot steering mode between automatic and manual, when connected to a FURUNO NAVpilot. When the mode is switched, a beep* sounds and one of the following messages appear.</p> <p>Manual mode→Automatic mode: "Navpilot has started". Automatic mode→Manual mode: "Navpilot navigation canceled".</p> <p>*: The beep sound can be turned on or off with [Alarm Sound when NAVpilot is engaged]. See page 2-22.</p>
11	Brill key	<ul style="list-style-type: none"> • Opens the [Quick Access] window. • Displays the brilliance adjustment window when the [Quick Access] window is open.

1.2.3 Remote Control Unit group settings

If multiple units are installed in the network, you can select the display to show on a unit, using the MCU-005, MCU-006, MCU-006H*. Additionally, you can select the order in which to cycle through the displays.

*: Not supported by NavNet TZtouch 2.

Note: Confirm that there are no duplicate unit nicknames in the network. If a duplicate name is found, change the name on the [Sensor List] ([Initial Setup]→[Data Sensors]→[Sensor List]).

1. Home page→[Settings]→[Initial Setup].
2. Tap [Remote Controller Configuration] twice.

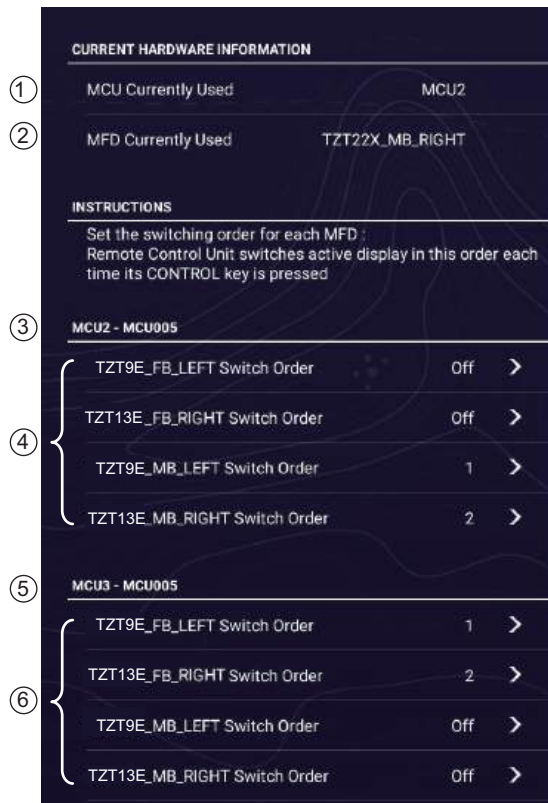

Example remote configuration - MCU-005

1. SYSTEM INTRODUCTION

No.	Description
1	The nickname automatically assigned to the MCU-005.
2	The nickname assigned to the TZMAP9/13 or TZT9E/13E unit currently being operated.
3	Setting for MCU2. See the figure below.
4	Set the selection and ranking of displays operated by MCU2. Displays set to [Off] cannot be operated.
5	Setting for MCU3. See the figure below.
6	Set the selection and ranking of displays operated by MCU3. Displays set to [Off] cannot be operated.

Based on the menu settings shown on the previous page, the installed configuration should look similar to the following image.

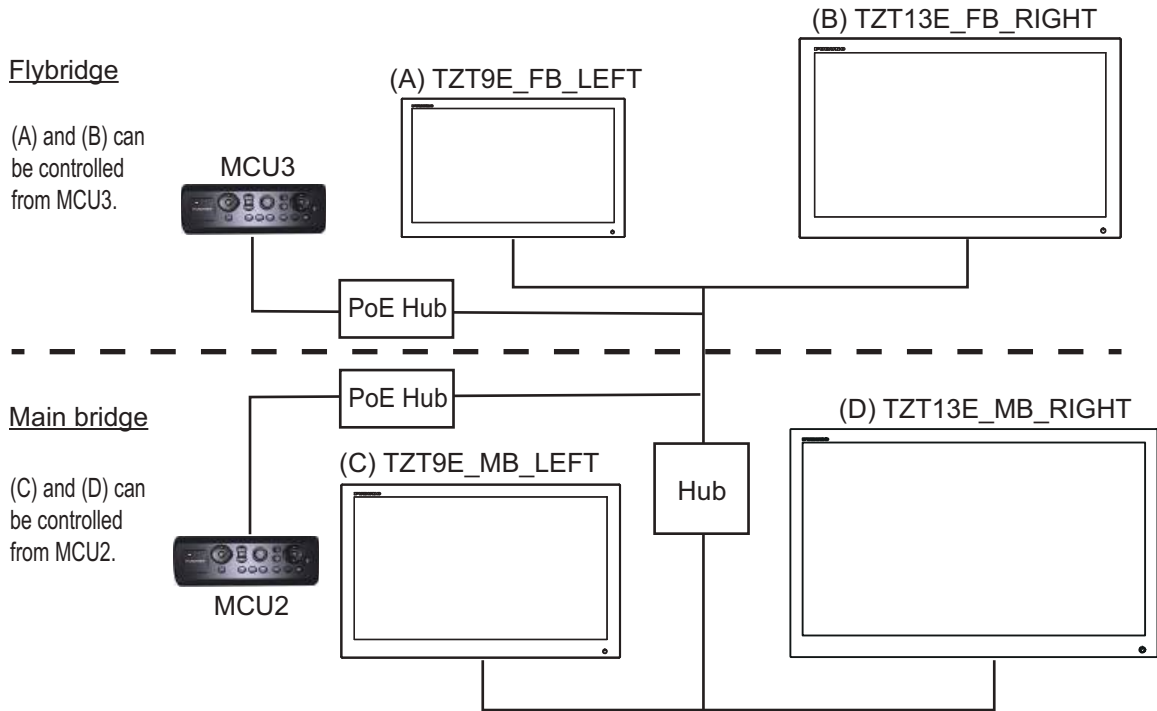

3. Select the displays to cycle.

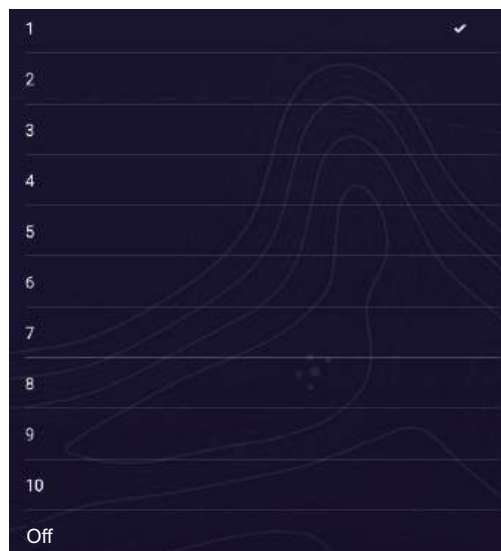

4. Set the order. To skip a display, select it to [Off].
5. Tap [<] on the title bar to return to the [REMOTE CONTROLLER CONFIGURATION] menu.
6. Tap the [Confirm] button on the title bar to save settings and close the menu.

1.3 How to Turn the Power On or Off

1.3.1 How to turn the power on

Press the power button on the left side of the display unit to turn the power on. The equipment beeps twice and the start-up screen appears. After the startup process is completed, the welcome screen appears, as shown below.

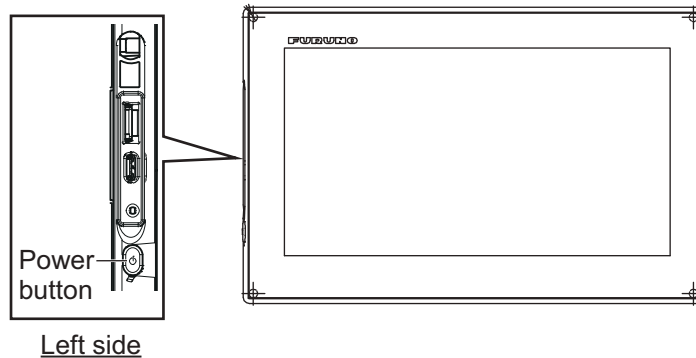

Tap desired function, referring to the descriptions below.

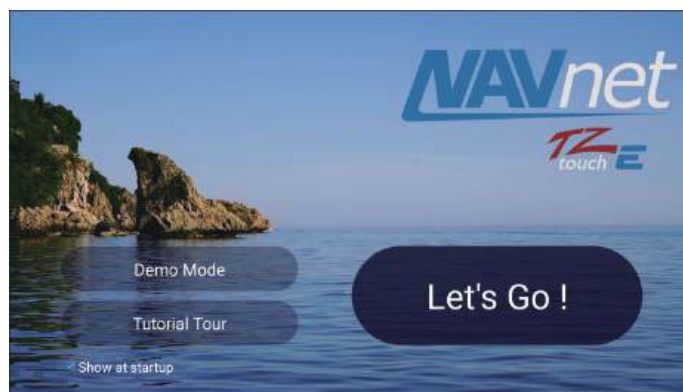

Note: When the password is registered for [Password Lock at startup], the password input screen appears. Enter the password to show the welcome screen (see section 1.22 for details).

Note: The Demo mode is intended for use by dealers. Do not use this mode. Improper use may cause loss of setting data.

[Demo Mode]: Tap [Start] to start the Demo mode. To stop the Demo mode, Home page→[Settings]→[General]→[Demo]→[Stop Demo].

[Let's Go!]: Start normal operation (the equipment starts up with the last-used display).

[Tutorial Tour]: Tap to start the tutorial tour. You can stop the tour at any time by tapping the screen. A confirmation message appears; tap [OK] to stop the tour.

[Show at startup]: Check its box to get the welcome screen each time the equipment is powered. Remove the checkmark to hide the welcome screen at power-up. You can also show or hide the welcome screen* from the menu.

*: To show or hide the welcome screen, Home page→[Settings]→[General]→[Demo]→turn [Show Welcome Screen at startup] on or off.

1. SYSTEM INTRODUCTION

After the welcome screen is cleared, the [NAVIGATION WARNING] screen appears. Read the warning, then tap [OK].

Note: If the password is not registered, a pop-up screen appears. Select [YES] to show the password input screen to set the password, or select [NO] to close the pop-up screen. If [DO NOT ASK AGAIN] is selected, the pop-up screen does not appear at the next startup. However, certain menu settings can not be changed without the password registration. See section 1.22 for how to set the password.

The [WARNING - LIMITATIONS ON USE] screen appears. Read the warning, then tap [OK].

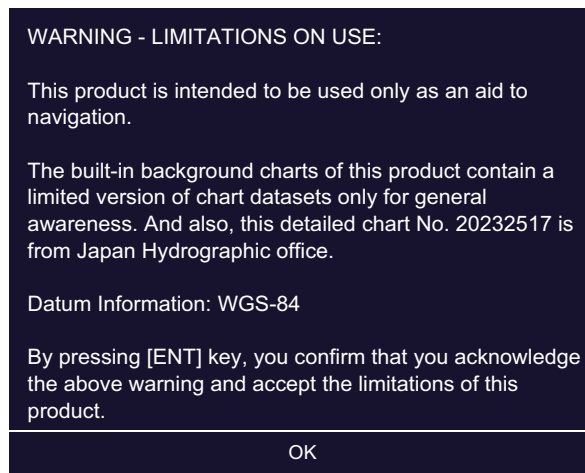
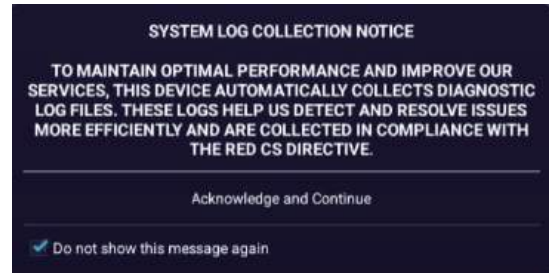

At the system startup, the system asks the user for permission to collect diagnostic logs for security hardening to identify and resolve issues more efficiently. Select [Acknowledge and Continue]. If you put check mark ✓ to [Do not show this message again], this message will not appear anymore during system startups.

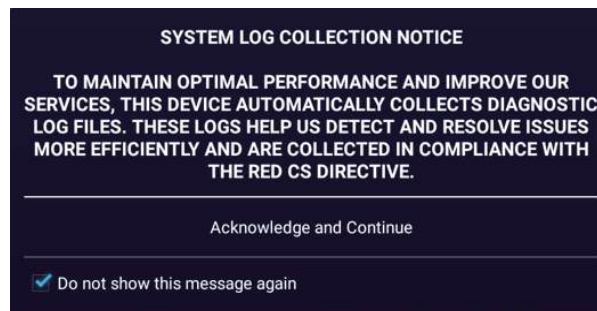

1.3.2 How to turn the power off

Press the power button on the left side of the display unit to show the [Quick Access] window.

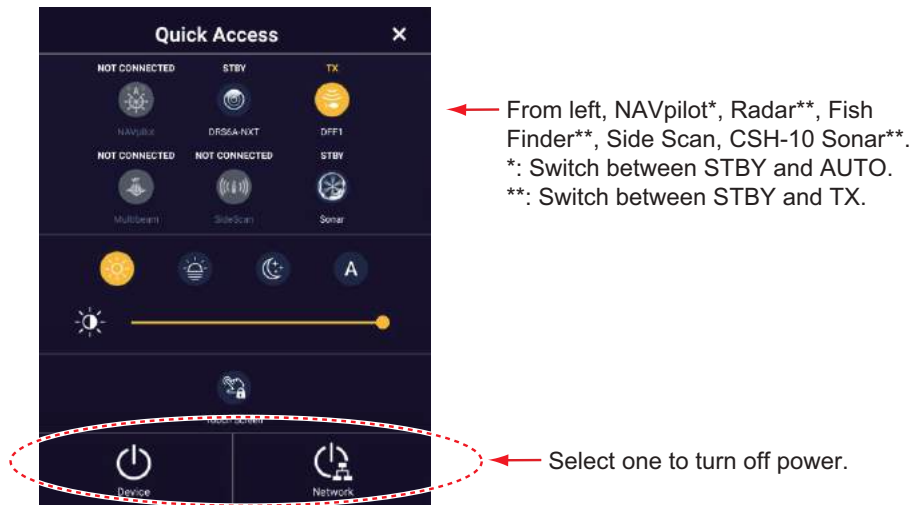

Tap [Device] to power off only the TZMAP9/13 or TZT9E/13E unit, or [Network] to power off the TZT9E/13E unit and all other units in the network. A beep sounds, the message "Shutdown in progress" appears, then the unit shuts down shortly thereafter.

Note 1: If you cannot turn off the power as shown above, or the screen has frozen, press the reset button to restart the system.

Note 2: Do not turn off the power during the start-up. Wait until the start-up is completed before turning off the power.

Note 3: The screen refreshes slower in low ambient temperature.

1.3.3 How to turn the power off remotely (TZT9E/13E only)

To turn the power off from other connected devices, tap Home page→[Settings]→[General]→[This Display]→ tap [Allow Remote Shutdown] flip-switch to on.

Note 1: The [Allow Remote Shutdown] setting is password protected. When the password is required, the menu is masked and the lock icon is shown. Tap and enter the registered password to unlock the password protection and change the setting.

Note 2: When this function is set to on, the system can be turned off remotely at any time, which may affect navigation.

1.4 How to Adjust the Brilliance and Hue of the Display

With the power applied, Press the power button to show the [Quick Access] window.

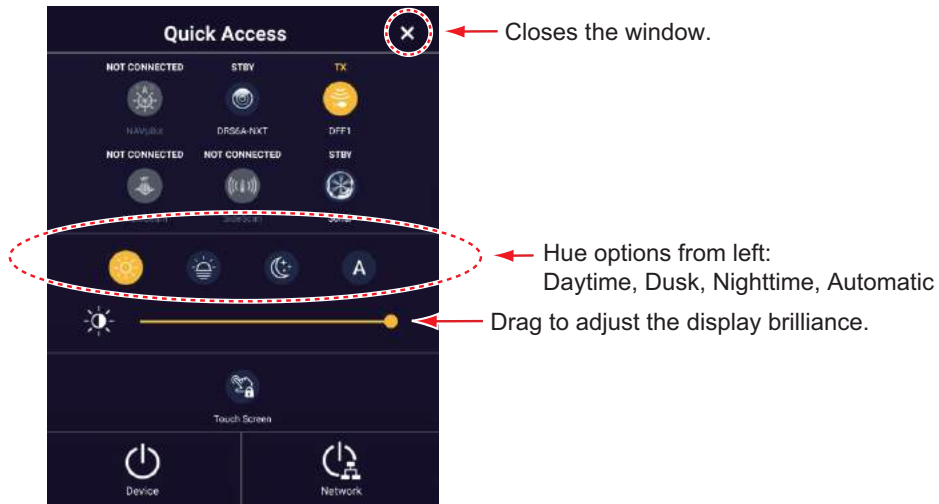

To adjust the brilliance, drag the slider thumb on the slider bar, or tap the slider bar.

To select the hue, tap the applicable icon above the slider bar. The [A] (Auto) icon automatically adjusts the hue according to the time of day at your ship's position.

Note: If the brightness setting is less than 14 at power off, the brightness is automatically set to 14 at the next power up.

How to synchronize brilliance of units in the network (TZT9E/13E only)

Home page→[Settings]→[General]→[This Display]→turn on [Brilliance Synchronization] to synchronize the brilliance among units in the network.

Note: Hue settings are not synchronized among multi function displays in the network.

1.5 Home Page

The Home page is where you access functions and menus, select displays, and check sensor status. Tap the [FURUNO] icon at the top left corner to show the Home page. The Home page is automatically closed, and the previous operation display restored, when no operation is detected for approximately one minute.

The figure below shows an example display with all sensors and corresponding devices connected.

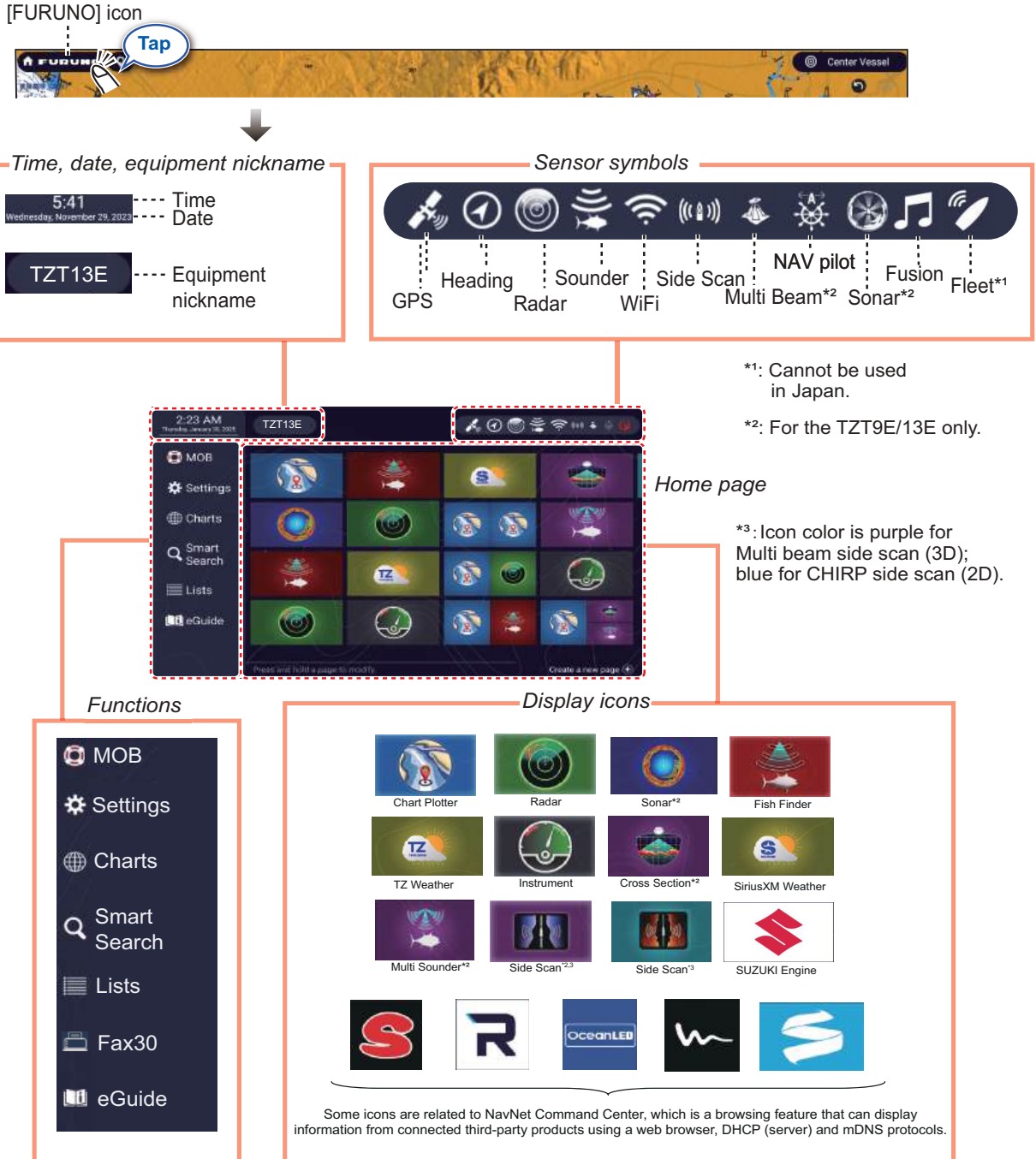

1. SYSTEM INTRODUCTION

Time/Date/Equipment nickname show the date/time and the nickname of your unit, which can be changed to your liking. Tap the nickname to show the software keyboard. Change the nickname. See section 1.15 for how to use the software keyboard.

The **Sensor symbols** show the sensors connected in the system and their status, in the following colors.

White: Sensor normal

Red: Sensor error

Gray: Sensor inactive (stopped)

The **Functions** section provides the features mentioned below. ([MOB] is permanently fixed.)

[MOB]: Enters a MOB mark, which marks man overboard location on the chart plotter and radar displays. See section 1.19.

[Settings]: Menus (general, chart plotter, radar, fish finder, etc.) for customization of the system. See section 1.15.

[Charts]: Provides various chart-related operations - chart update, TZ MAPS store (chart purchase), and chart catalog.

[Smart Search]: Search for routes, AIS, points, tides, marinas, or moorings (harbors) (see section 2.8).

[Lists]: Accesses the lists (points, routes, tracks, boundaries, photos, catches, AIS, DSC, ARPA, Alarms, Active Route Detail, Planning Route Detail (Fleet)).

[FAX30]: Opens the FAX-30 operation screen. Requires FAX-30. See section 16.4.

[eGuide]: Opens the abbreviated operator's manual.

The **Display icons** select corresponding displays. See the next section for details.

How to reset the Home page

You can easily reset the Home page to default. Home page→[Settings]→[Initial Setup]→[Home Page]→[Factory Reset]. A message asks if you are sure to reset your Home page configuration. Tap [OK] to reset the Home page to default.

1.6 How to Select a Display

You have two methods from which to select a display, the Home page and the Quick page.

1.6.1 How to select a display from the Home page

Tap the [FURUNO] icon to show the Home page, then tap the applicable display icon. (It may be necessary to swipe the screen if you have programmed a number of display icons.)



Note: The display icons can be edited (size changed, layout rearranged, icon deleted, etc.). See subsection 1.7.2.

1.6.2 How to select a display from the Quick page

The Quick page lets you change the display from the current display without having to go the Home page.

To show the Quick page, swipe the top of the screen downward. Tap desired display icon to change the display.

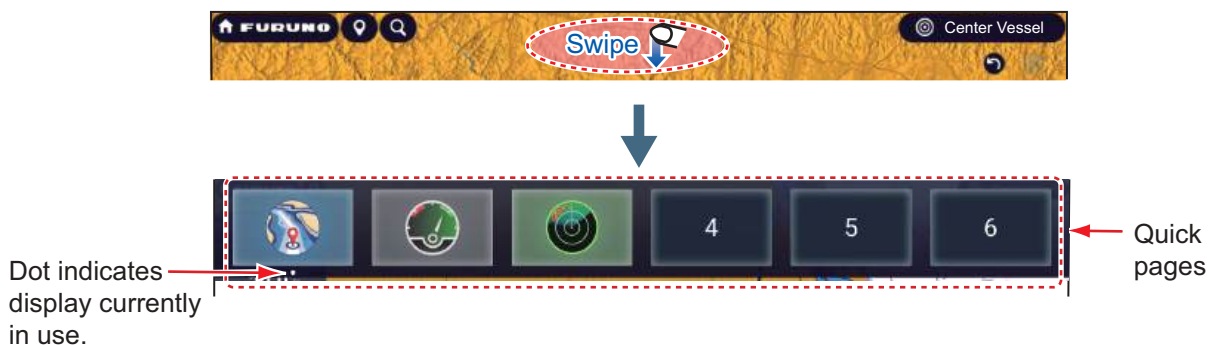







How to add the current display to the Quick page

Select the display that you want to add to the Quick page. Show the Quick page, then long tap an icon. The icon corresponding to the current mode appears in the Quick page.

1.7 How to Edit the Display Icons

The default Home page arrangement provides display icons in a configuration according to the equipment that you have in your network. If the arrangement does not meet your requirements, you can rearrange the icons to suit your needs. You can have a maximum of 32 display icons, and a screen may be divided in 10 different ways.

Note: The available configurations depend on the display division selected and your system configuration. The table below outlines the screen divisions and the displays available. An icon is greyed out when it cannot be selected to a multi-split screen. See subsection 1.7.1.

Screen division	Available display
	Chart plotter, radar, sonar* ³ , fish finder, weather, instrument, cross section* ³ , multi sounder* ³ , side scan* ³ , SUZUKI engine, browse
	1, 2: Chart plotter, radar, sonar* ^{1,3} , fish finder* ¹ , multi sounder* ^{1,3} , side scan* ^{1,3} , browser.
	1: Chart plotter, radar, sonar* ^{1,3} , fish finder, multi sounder* ³ , side scan* ³ . 2, 3: Chart plotter, radar, sonar* ^{1,3} , fish finder* ¹ , instrument, cross section* ^{1,3} , multi sounder* ^{1,3} , side scan* ^{1,3} , SUZUKI engine, browser.
	1~4: Chart plotter, radar* ² , sonar* ^{1,3} , fish finder* ¹ , instrument, cross section* ^{1,3} , multi sounder* ^{1,3} , side scan* ^{1,3} , SUZUKI engine, browser.
	1, 2: Chart plotter, fish finder* ¹ , cross section* ^{1,3} , multi sounder* ^{1,3} , side scan* ^{1,3} , browser.
	1~3: Chart plotter* ² , radar* ² , sonar* ^{1,3} , fish finder* ¹ , multi sounder* ^{1,3} , side scan* ^{1,3} , browser.
	1, 2: Chart plotter, radar, sonar* ^{1,3} , fish finder* ¹ , instrument, cross section* ^{1,3} , multi sounder* ^{1,3} , side scan* ^{1,3} , SUZUKI engine, browser. 3: Chart plotter, fish finder, cross section* ³ , multi sounder* ³ , side scan* ³ , browser.

*1: Only one screen can be registered.

*2: Two screens can be registered.

*3: For the TZT9E/13E only.

1.7.1 How to add a new display icon

1. Tap the [FURUNO] icon to show the Home page.
2. Tap the [Create a new page ] icon on the right bottom corner.
Note: When all available display icons (32) have been used, a new icon cannot be added. Erase an unnecessary icon to make room.
3. Follow the instructions in the figure below to create a display icon.

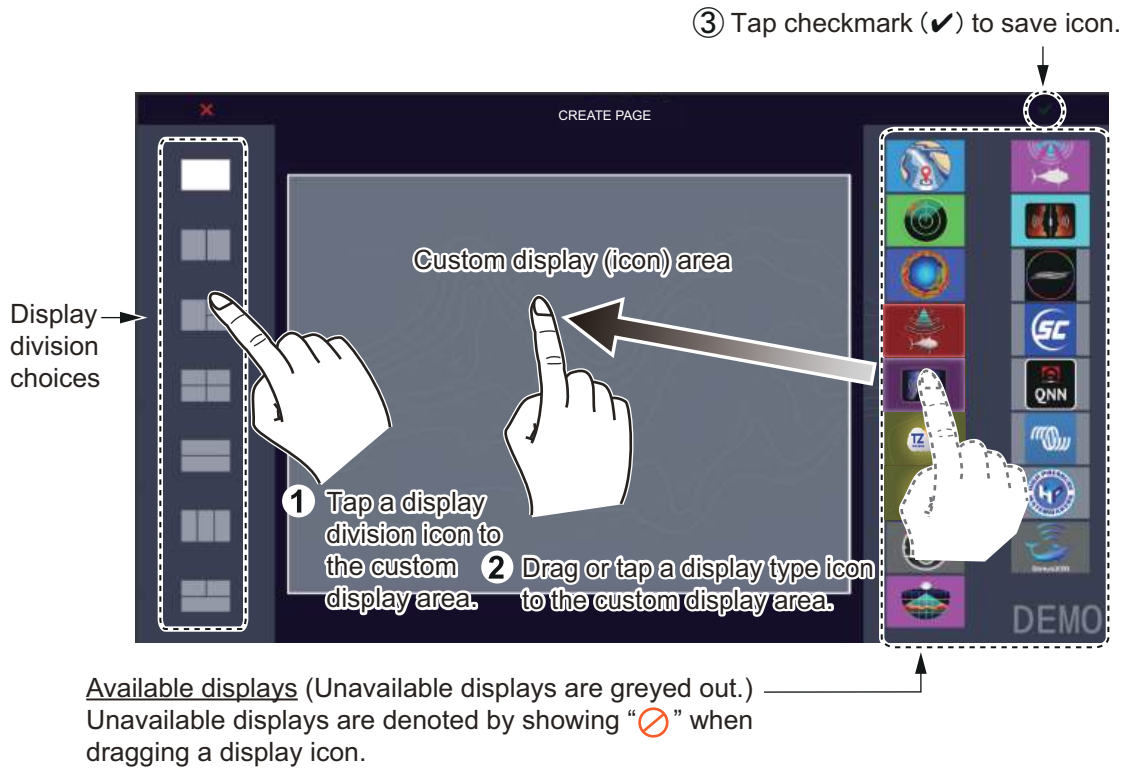

Tap the checkmark (✓) to finish and close the window. The display screen created appears, and the Home page is updated to reflect the addition.

1.7.2 How to edit a display icon

To organize the screens (icons) on the Home page, long-tap the screen icon you want to change, then tap the appropriate icon at the corners of the display (see the figure below) - change contents of icon, remove icon, or change size of icon.

Note: The chart plotter display icon, which initially appears at the top left corner of the display screen icons, cannot be deleted or edited, but it can be resized. Other display screen icons can be deleted, edited, resized as desired.

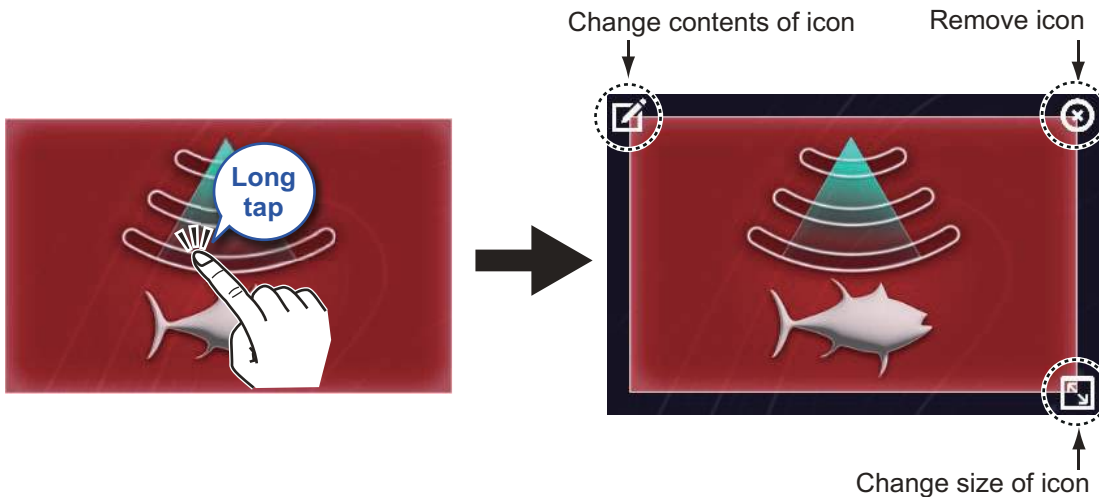

Edit icon content: Tap the icon to show the [EDIT PAGE] display (see subsection 1.7.1). Then, change the configuration as necessary.

Remove icon: Tap the icon to delete the corresponding display icon from the Home page.

Change icon size: Tap the icon to switch the size between large and small. Tap anywhere other than an icon to confirm change.

Any changes made on the Home page are not reflected on the Home pages of other NavNet TZtouch series connected on the network.

1.8 Edge Swipe Functions

This equipment has four edge swipe functions and a tap Pop-up menu.

- Quick page
- Slide-out menu
- Pop-up menu
- Layers menu
- Data window

Swipe the screen (tap for the Pop-up menu) at the locations shown below to access those functions.

Windows other than the Data window are automatically erased from the screen when it is not operated within the time specified. You can specify how long to leave a window open with Home page→[Settings]→[General]→[This Display]→[User Interface Auto-Hide]. You can erase a window at any time by tapping the screen. To close the Layers menu, tap [×] on the title bar.

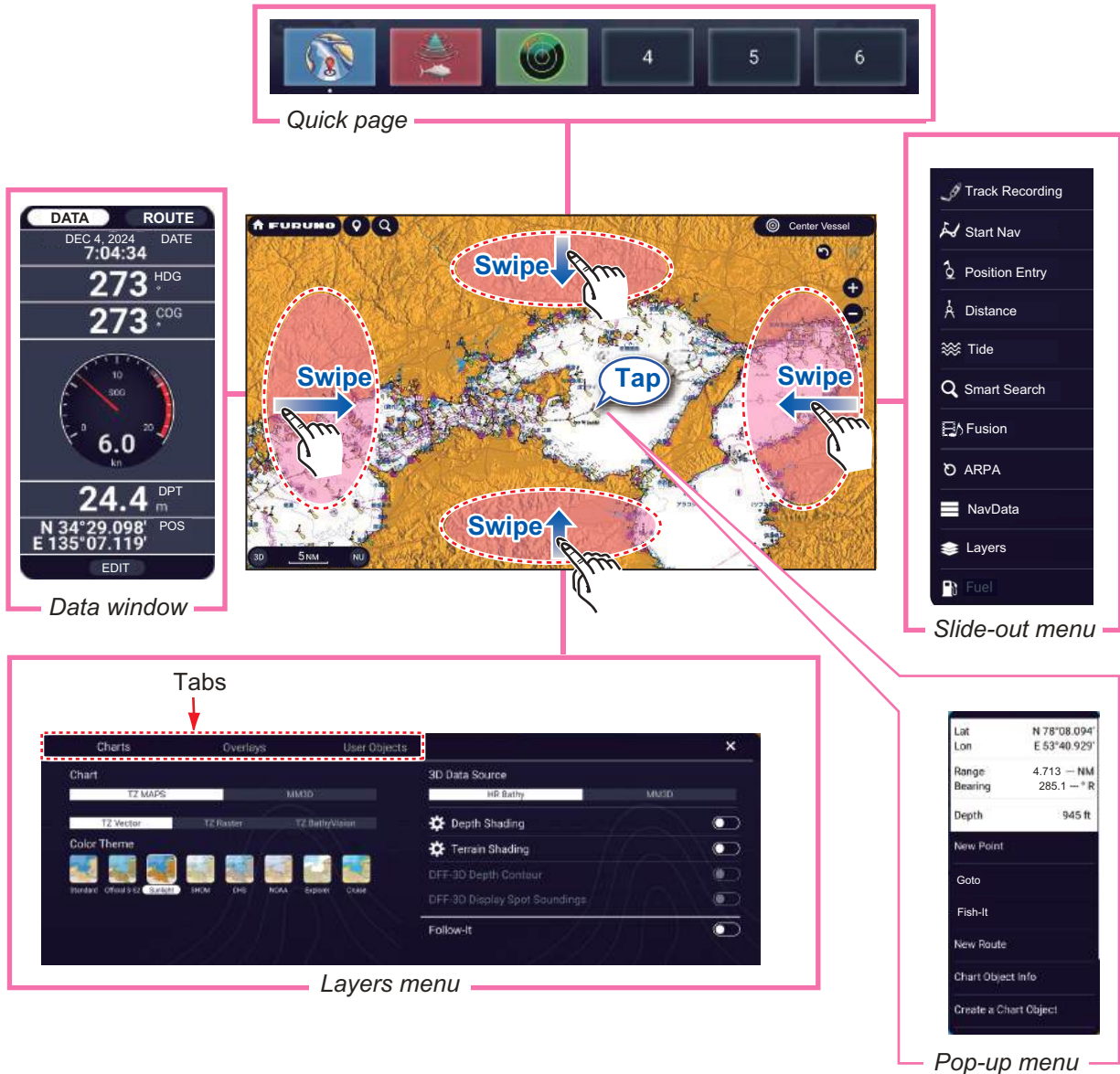

Function description

The **Quick page** selects displays. See subsection 1.6.2.

The **Slide-out menu** provides quick access to several universal functions. Swipe from the left or right edge of the screen to show the Slide-out menu. To execute a function, tap the function name. Unavailable functions are grayed out. The color of the icon changes according to function status, yellow for On, white for Off.

The **Pop-up menu** provide a subset of functions that are relevant to the object or location tapped. To execute a function, tap the function name. Unavailable functions are grayed out. Functions that have “>” at the end of their name indicate additional functions are available.

The **Layers menu**, organized by tabs, provides quick access to often-used functions and detailed settings for the active display. To show the Layers menu, swipe up from the bottom edge of the screen. Tap a flipswitch to turn a function on (☑) or off (☐). Unavailable functions are grayed out. This menu can also be opened from the Slide-out menu. You can switch between tabs by swiping or tapping them.

1. SYSTEM INTRODUCTION

Note 1: For the multi-screen display, the active display, which is circumscribed with an orange rectangle, can be operated from the Layers menu.

Note 2: The Layers menu is not available with the instrument display. All functions are available on all other displays (items displayed vary depending on the display type).

The figure below shows examples of the main tab of the Layers menu for the fish finder, radar, and weather displays. The content changes according to the device connected.

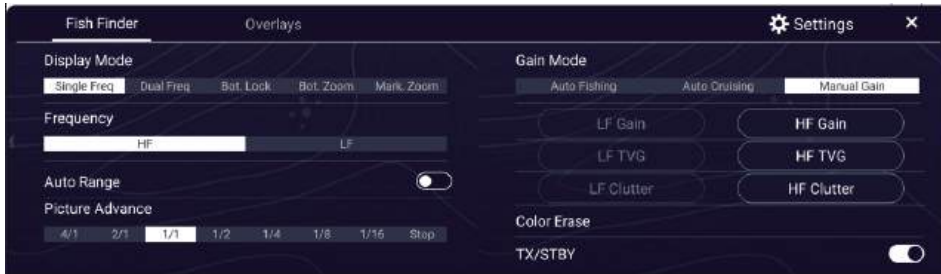

Fish Finder Layers menu

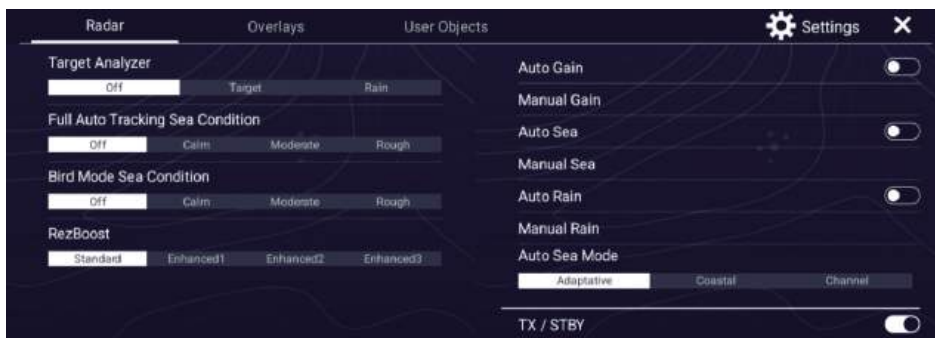

Radar Layers menu



Weather Layers menu

The **Data window** shows navigation data. See the next section for details.

1.9 Data Window

The Data window, which appears at the left side of the screen, shows various navigation data, in movable and editable data boxes. You can select the data to display, select display format, and change the arrangement of the data boxes in the window. Any changes are reflected to other connected units in the network. The data that can be displayed depends on system configuration.

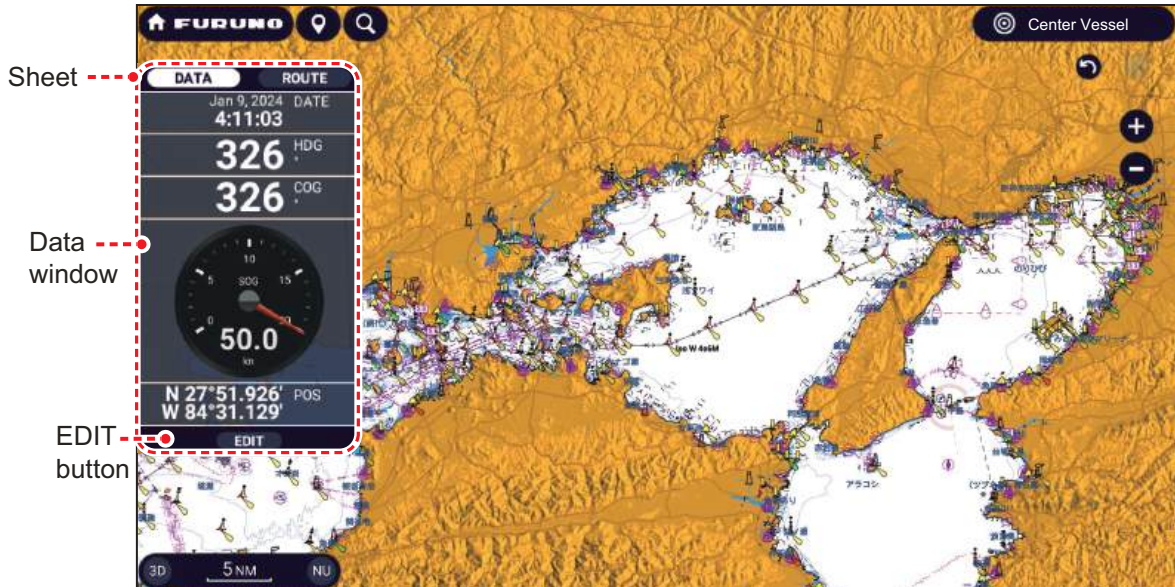

Note: The Data window is also available in all split screens, on the left edge.

To show the Data window, swipe the screen rightward from the left edge of the screen, or open the Slide-out menu and tap [NavData]. Three yellow bars appear to the left of [NavData] when the Data window is displayed. A maximum of two “tabs”* of nav data can be shown in the Data window, and the current categories are named at the top of the Data window. To switch category names, tap the applicable category name. Each category contains numerous data boxes. Hidden data boxes can be shown by scrolling the Data window up or down.

* The seven categories are as shown in the table below.

Data category	Content
[DATA]	Shown on all display modes.
[ROUTE]	Shown with the chart plotter display.
[RADAR]	Shown with the radar display.
[FISH FINDER]	Shown with the fish finder display.
[DFF-3D]	Shown with the DFF-3D display (multi beam sonar, cross section). (Excluding side scan.)
[SIDE SCAN]	Shown with the side scan display.
[SONAR]	Shown with the CSH-10 display (scanning sonar).

1. SYSTEM INTRODUCTION

1.9.1 How to change the order of the data boxes

1. Tap the [Edit] button below the Data window to show the [Edit NavData] display screen.

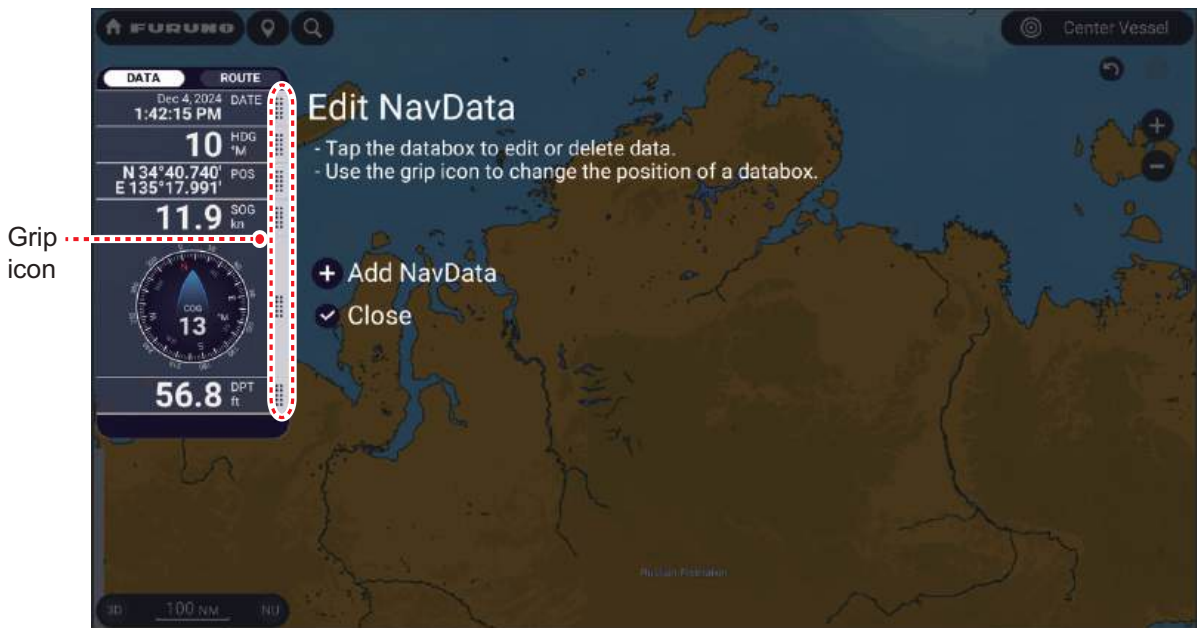

2. Press and hold the grip icon of the data box to move, then drag and drop the box to its new location.
3. Tap [✓] to finish and close the [Edit NavData] display screen.

1.9.2 How to change the contents of a Data window

1. Tap the [Edit] button below the Data window to show the [Edit NavData] display screen.
2. Tap the data for which you want to change its contents. The [Modify NavData] window appears.

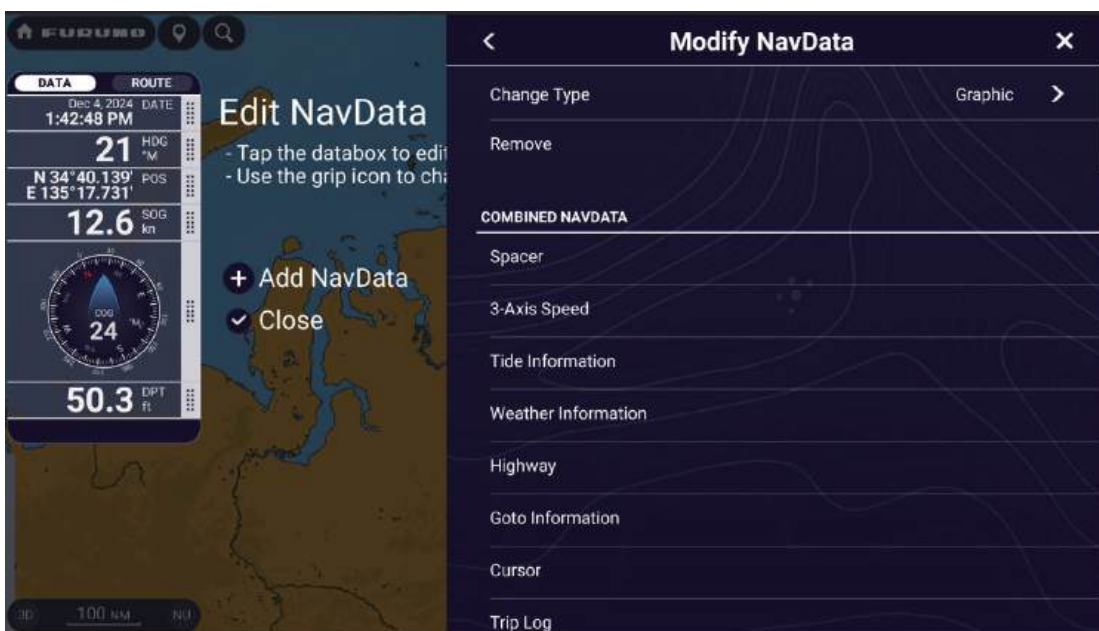

3. In the [Modify NavData] window, tap desired data. Displayable data is shown in the table below. Greyed out data cannot be used.

COMBINED NAVDATA		
Spacer	Laylines Information	3-Axis Speed
Tide Information	Weather Information	Highway
Intercept	Goto Information	Cursor
Trip Log	Trip Log 2	NAVpilot
Radar	Sonar*	Sonar Tilt Angle*
Sonar Event History*	EBL / VRM	Fish Finder Gain Control
Multi-Sounder Gain Control*	Bottom Discrimination	Boundary Alarm Zone
Trim Tabs		
NAVIGATION DATA		
Date/Time	COG - Course Over Ground	SOG - Speed Over Ground
Boat Position	HDOP	DPT - Depth
HDG -Boat Heading	CTW - Course Through Water	STW - Speed Through Water
Set - Current Direction	Drift - Current Speed	ROT - Rate of Turn
ODO - Total cumulative distance	Roll	Pitch
Power Supply Voltage	Rudder	
ROUTE INFORMATION		
BTW - Bearing To Waypoint	NEXT - Next Course	TTG - Time To Go (using VMC)
DTW - Distance To Waypoint	XTE - Cross Track Error	ETA - Estimated Time of Arrival
TTA - Total Time to Arrival	DTA - Distance to Arrival	HTS - Heading to Steer
VMG - Velocity Made Good	VMC - Velocity Made Course	
WIND AND WEATHER		
SST - Sea Surface Temperature	TWD - True Wind North	TWA - True Wind Angle
TWS - True Wind Speed	AWA - Apparent Wind Angle	AWS - Apparent Wind Speed
Atmospheric Pressure	Air Temperature	Humidity
Dew Point	Wind Chill Temperature	
ENGINE AND TANK		
ENGINE**	ENGINE 2**	ENGINE 3**
ENGINE 4**	ENGINE 5**	ENGINE 6**
TOTAL ENGINE Fuel Rate	FUEL	FUEL 2
FUEL 3	FUEL 4	FUEL 5
FUEL 6	MANUAL FUEL	FRESH WATER
WASTE WATER	LIVE WELL	BLACK WATER
OIL	Total Fuel	Fuel Time to Empty
Fuel Distance to Empty	Fuel Consumption	Fuel Economy

*: Available for the TZT9E/13E only.

** : The following options are available for ENGINE to ENGINE 6.

Fuel Rate	RPM	Boost Pressure
Oil Pressure	Oil Temperature	Temperature
Trim	Alternator Potential	Coolant Pressure
Fuel Pressure	Load	Hours
Transmission Oil Pressure	Transmission Oil Temperature	

4. Tap [✓] to finish and close the [Edit NavData] display screen.

1. SYSTEM INTRODUCTION

1.9.3 How to add a data box to a Data window

1. Tap the [Edit] button below the Data window to show the [Edit NavData] display screen.
2. Tap an unoccupied area in the Data window to show the [Add NavData] window. You can also show this window by tapping [Add NavData].

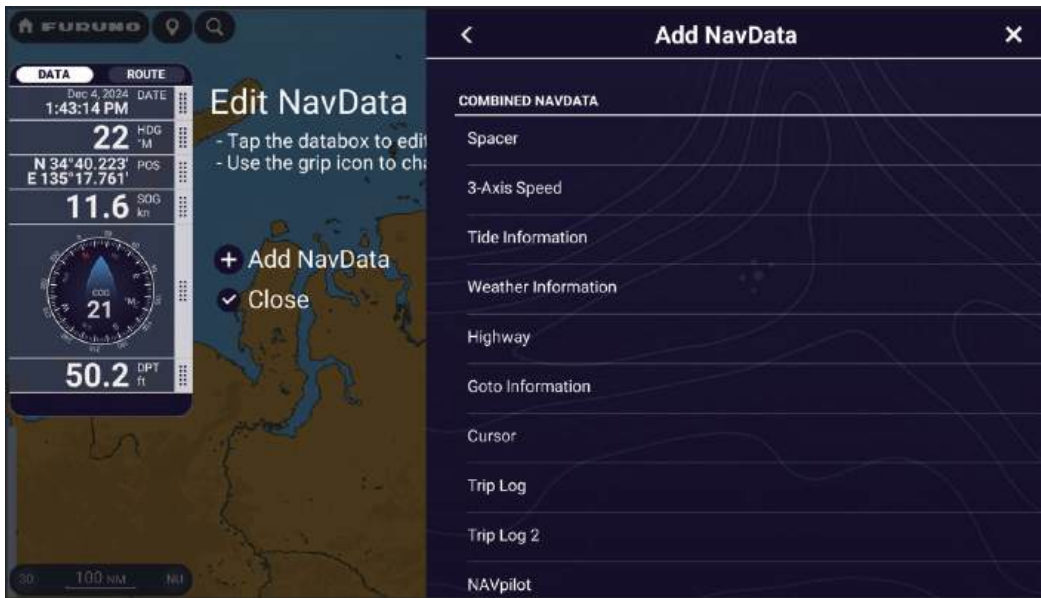

3. Tap desired data in the menu. See step 3 of section 1.9.2 for available data. The data added appears at the bottom of the Data window. In the example below, the [Cursor Information] data box has been added.

Note: When Spacer is selected, a space is added between the data boxes. Adding Spacer between unrelated data, such as between fish finder and a radar data boxes, makes the data easier to observe.



4. Tap [✓] to finish and close the [Edit NavData] display screen.

1.9.4 How to delete a data box

1. Tap the [Edit] button below the Data window to show the [Edit NavData] display screen.
2. Tap the data box to delete, and the [Modify NavData] window appears.
3. Tap [Remove].
4. Tap [✓] to finish and close the [Edit NavData] display screen.

1.9.5 How to change the display method for the data in a Data window

The data in the data boxes can be shown in graphic, numeric, or graph format.

1. Tap the data box for which to change its display method.
2. At the top of the [Modify NavData] window, tap [Change Type].
3. Tap [Graphic], [Numeric] or [Graph] as appropriate. The figure below shows the appearance of SOG data in the available display formats.



[Graphic]
Analog format



[Numeric]
Digital format



[Graph]
Graph format

For [Graph], the plotting period (horizontal axis) and plotting range (vertical axis) can be changed.

- 1) Tap the data box to change.
- 2) Tap [Plot Period]*, then tap desired period, among 1'00s, 5'00s, 10'00s, 30'00s, 1h00, 3h00', 6h00', 12h00', 1d00h, and 2d00h.
* Depending on the display time, the number of data points displayed on the graph may decrease, and the graph may become coarse.
- 3) Tap [Plot Range Value], and a software keyboard appears. Enter range value, then tap [✓].
- 4) Tap [×] to close the keyboard.
4. Tap [✓] to finish and close the [Modify NavData] window.

1.9.6 How to adjust the transparency of the Data window

1. Home page→[Settings]→[Chart Plotter]→[Transparencies].
2. Tap [NavData Transparency], then set desired transparency, from 0-80(%). The higher the transparency setting, the more the background becomes visible.
3. Tap [×] to finish and close the menu.

Note: Alpha blending technology is used for transparency effects.

1. SYSTEM INTRODUCTION

1.9.7 How to display 3-axis speed from the SC-33/SCX-20

When a SC-33/SCX-20 Satellite Compass™ is connected in your network, you can use a box in the Data window as a dedicated SC-33/SCX-20 display.

This function requires PGN 130578 Vessel Speed Components to be output from the SC-33/SCX-20.

Referring to section 1.9.2 and section 1.9.3, select the 3-Axis Speed display.

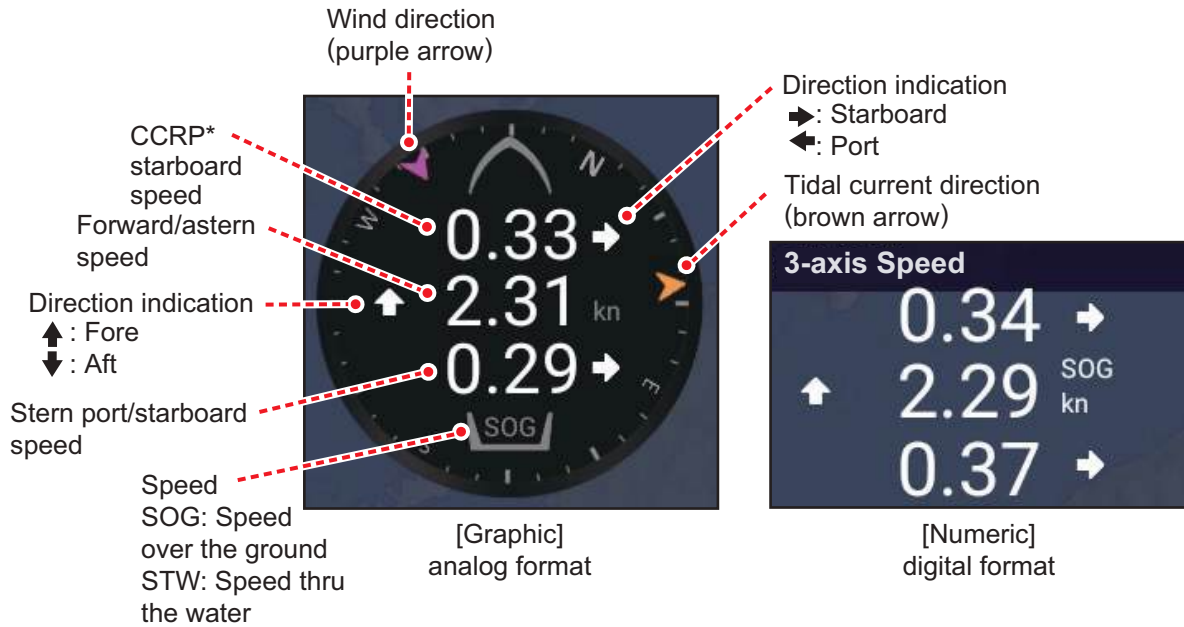

* CCRP (Consistent Common Reference Point) is determined at installation, and is either the bow, transducer location, or center of vessel.

1.10 User Interface

You can change the size of some items in the user interface, and those items are circumscribed in the figure below. The example shows the items in the [Medium] setting.

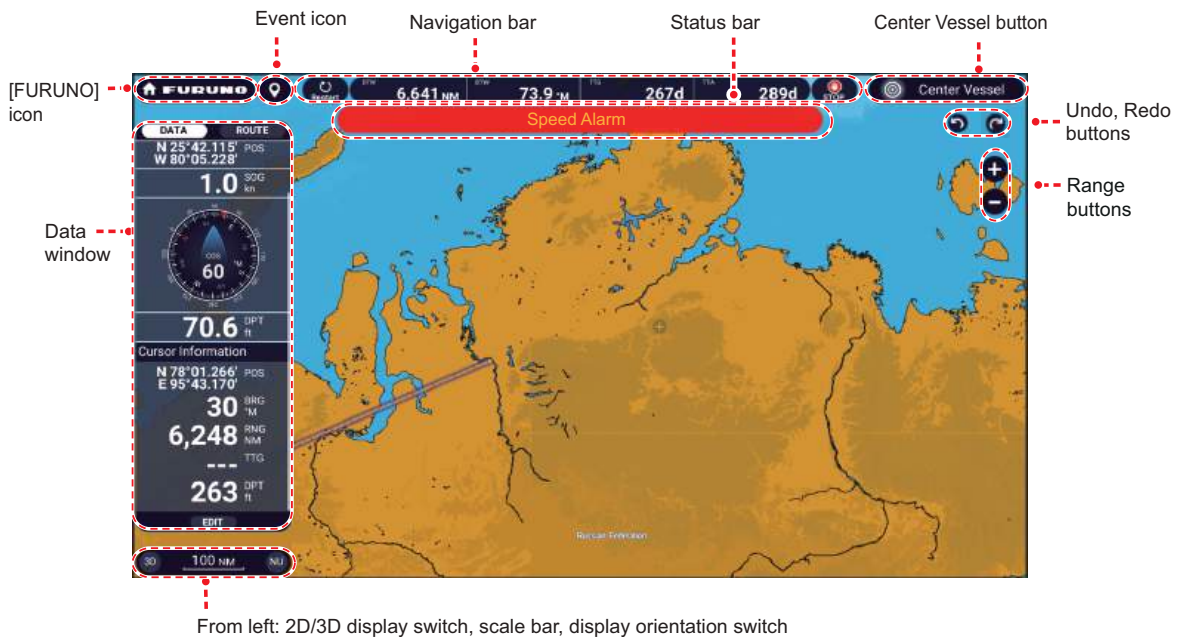

1. Home page→[Settings]→[General]→[This Display]→[Scale & Layout].

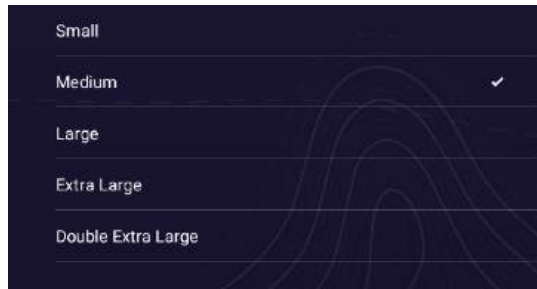

2. Tap desired size.
3. Tap [x] to finish and close the menu.

1

1.11 How to Use Storage Media

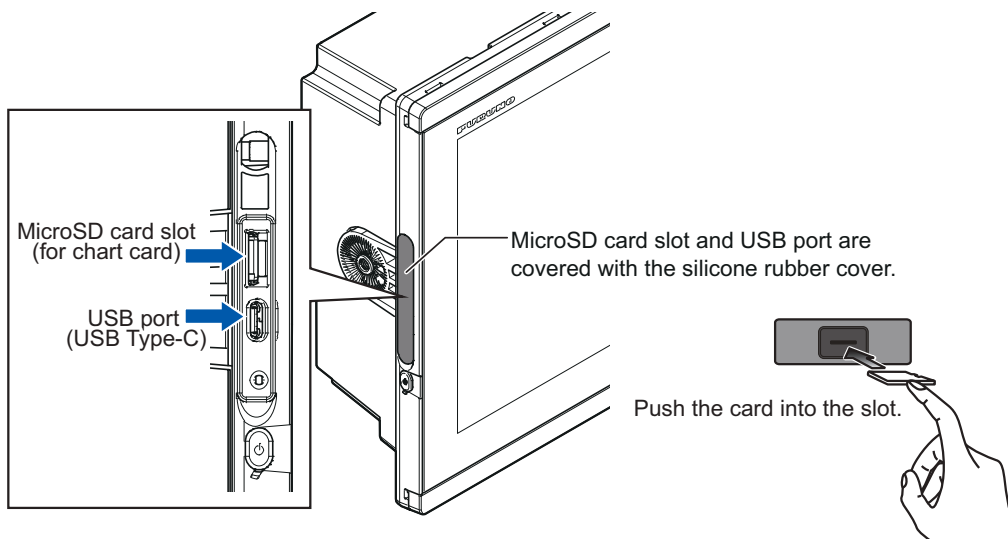

Note 1: The MicroSD card slot and USB port are positioned at a slight angle.

Note 2: To ensure the waterproofing performance, make sure to close the cover for the MicroSD card slot and USB port.

1.11.1 USB flash memory

Insert a USB flash memory (Type-C) into the USB port (Type-C) located on the left side of the display unit.

Usage guidelines

- The bus power output of the USB port is limited to 500mA. If the connected USB device is bus-powered, make sure its power output specification is within 500mA.
- Handle the USB flash memory carefully. Improper use can corrupt its contents.
- Do not remove a USB flash memory while the device is transferring or accessing information.
- Do not use the USB flash memory in rainy weather, during navigation, or in any situation where it may be exposed to water.
- To ensure waterproofing, check that the cover is securely closed.

1.11.2 MicroSD cards

How to insert a microSD card

Insert the microSD card into the card slot located on the left side of the display unit.

Note 1: Turn off the power before inserting or removing a microSD card.

Note 2: When closing the card slot cover, be sure to orient the logo (micro SD XC) on the cover in the correct direction. If installed in the opposite direction, waterproof properties may be lost.

How to format a microSD card

You do not normally need to format a microSD card. However, if the card becomes unreadable, format the card with a formatting program that is compatible with the specifications of the card. Formatting erases all data on the card.

How to remove a microSD card

1. Open the card drive cover.
2. Push the card to release the card from the card drive.
3. Remove the card with your fingers then close the cover.

About the microSD cards

- Handle the cards carefully. Improper use can damage the card and destroy its contents.
- Make sure the slot cover is closed at all times.
- Remove a card with only your fingers. Do not use metal instruments (tweezer, etc.) to remove a card.
- Do not remove a card while the device is transferring or accessing information.
- Do not use the card in rainy weather, during navigation, or in any situation where it may be exposed to water.



1.12 Chart Plotter Introduction

The chart plotter provides a world map in raster format, a vector chart for the US coast-line (with Alaska and Hawaii), and a vector chart with detailed contour lines. The chart plotter-related chapters show you how to enter points, and create and plan routes, on the chart plotter display.

The chart plotter receives position data fed from the internal GNSS receiver (TZT10X/13X/16X) or an external GPS receiver to mark your position on the display, with the vessel icon.

The points and routes you have entered are shown on the chart plotter display. You can move, delete and edit the points and routes from their respective Pop-up menus.

The chart plotter also provides the following functions:

- Displays own ship's track.
- Sets destination.
- Marks man overboard (MOB) position.
- Controls alarm functions.
- Measures distance and bearing.

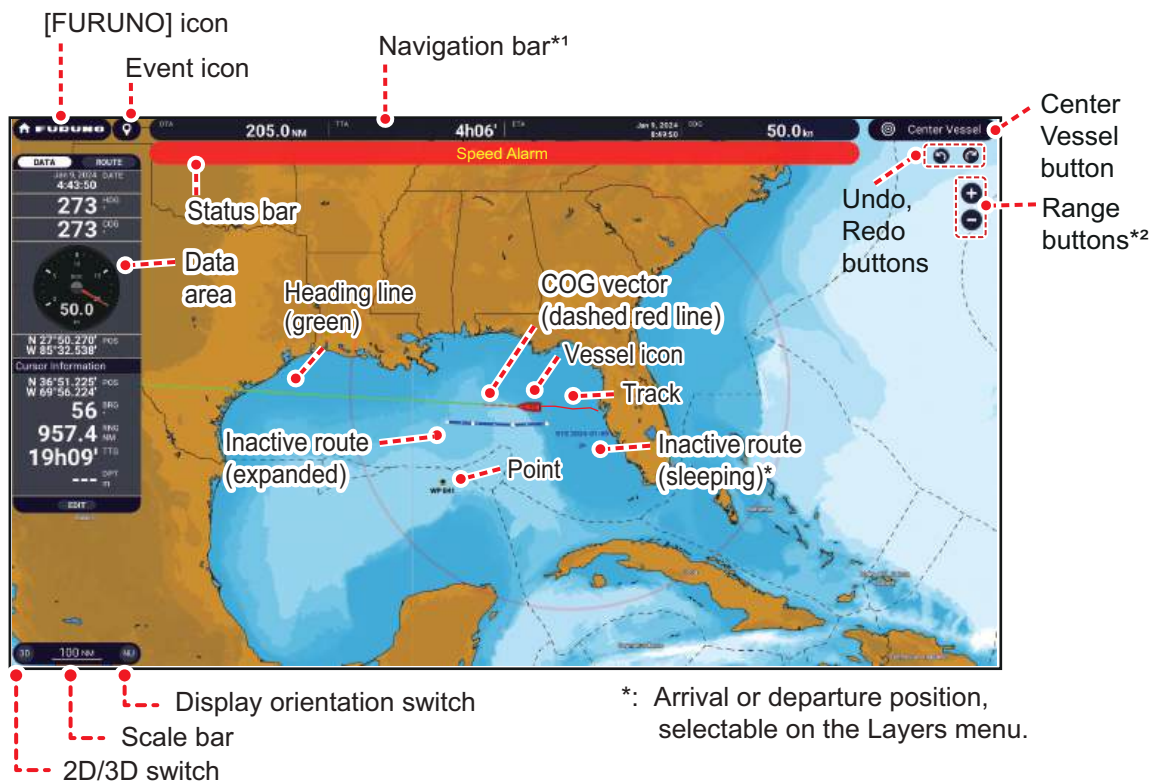

*1: When navigation bar is not shown, the Smart Search icon appears next to the Event icon (right side). See section 2.8 for details.

*2: When the [Show Range Slider] setting is turned on, the slider bar appears between the range (zoom in/out) buttons.

1. SYSTEM INTRODUCTION

Status bar

The Status bar, common to all modes, alerts you to equipment status. The color of both the bar and the status message change according to message category.

- **Red bar, yellow characters:** warning (alarm violation, equipment error, etc.)
- **Yellow bar, black characters:** caution (system message, notifications, etc.)

When an alert condition occurs, the equipment beeps (if enabled to do so), the name of the alert appears in the bar, and the bar flashes. You can stop the flashing and silence the beep by tapping the bar. The alert message remains in the bar until the cause for the alert is removed, or the offending alarm is disabled.

Undo, redo buttons

The **undo, redo** buttons have the following functions with points and routes.

- Undo button: Reverse the last change done.
- Redo button: Restore the undo action.

BathyVision display

When [TZ BathyVision] is selected as the chart type, an icon related to the contour line display appears above the scale bar at the bottom left of the screen, as shown in the figure below. You can choose density and density level for the contour lines. Additionally, you can also smooth the depth contours by averaging (smoothing).

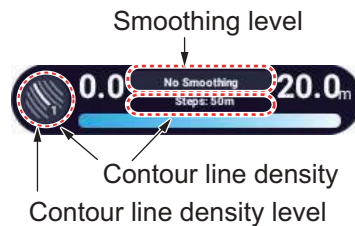

Contour line density

The contour line density changes according to the chart scale. For level 5, contour lines appear at maximum intervals of 0.1 m.

Smoothing

The settings are [Light Smoothing], [Medium Smoothing], [Strong Smoothing], [No Smoothing]. [Strong Smoothing] provides the greatest degree of smoothing.

1.13 Fish Finder Introduction

The fish finder display shows underwater images fed from a fish finder. Echoes are scrolled across the screen from the right position to the left position, which allows you to grasp the situation directly below the transducer in real time.

The echoes at the right position on the display are the current echoes. These echoes can be from individual fish, a school of fish, or the bottom. Depth to the bottom is indicated always (at the bottom left corner), provided the gain is set correctly. Past echoes can be viewed.

Both low and high TX frequencies are provided. (Frequencies determined according to the transducer connected.) The low frequency has a wide detection area, which is suitable for general detection and understanding bottom conditions. The high frequency has a narrow beam that helps you inspect fish in more detail when in shallow waters.

The gain can be adjusted automatically (fishing, cruising) or manually. When set to “fishing,” the image is automatically adjusted to suit fish detection. “Cruising” adjusts the image to suit sailing or cruising.

Note: The external fish finder is compatible with the TZT9E/13E only.

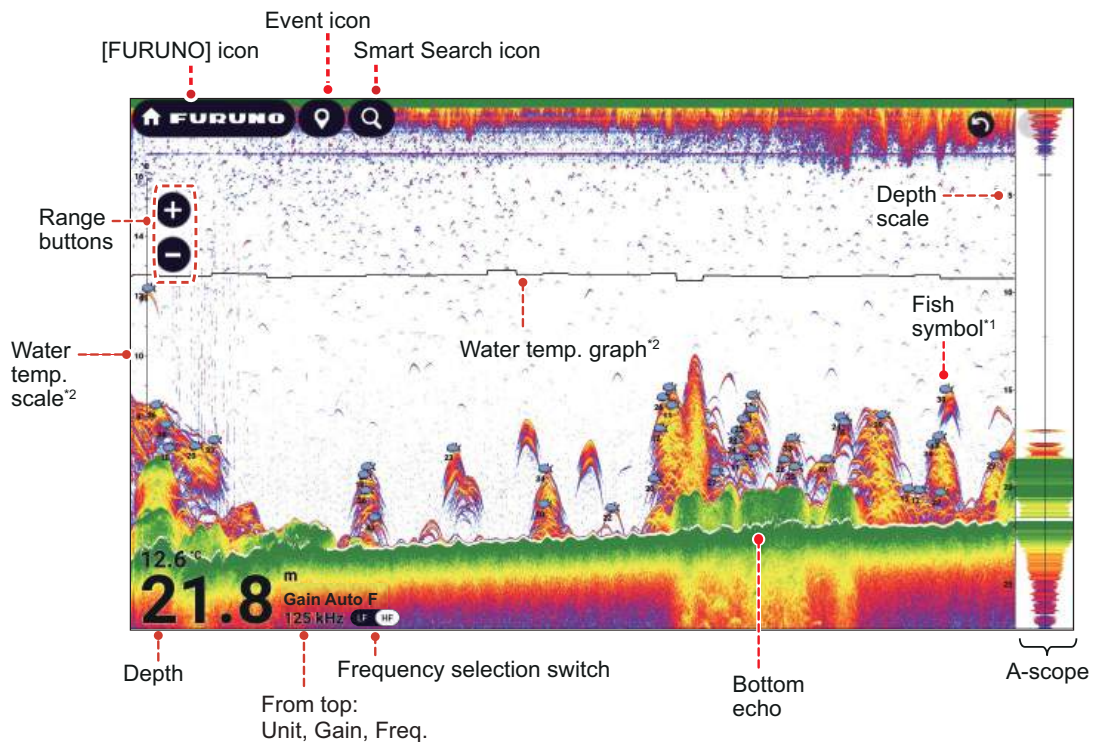

*1: Requires ACCU-FISH™ compatible transducer on the network.

*2: Requires water temperature sensor.

*3: When the [Show Range Slider] setting is turned on, the slider bar appears between the range (zoom in/out) buttons.

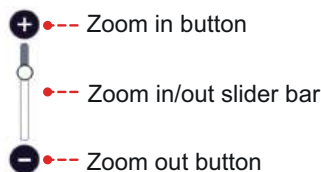

1.14 Radar Introduction

A radar system operates in the microwave part of the radio frequency (RF) range. The radar detects the position and movement of objects. Objects are shown on the radar display at their measured distances and bearings in intensities according to echo strength.

The orientation can be chosen from head up or north up.

A guard zone, set by the radar operator, tells you when a radar target has entered the area you specify.

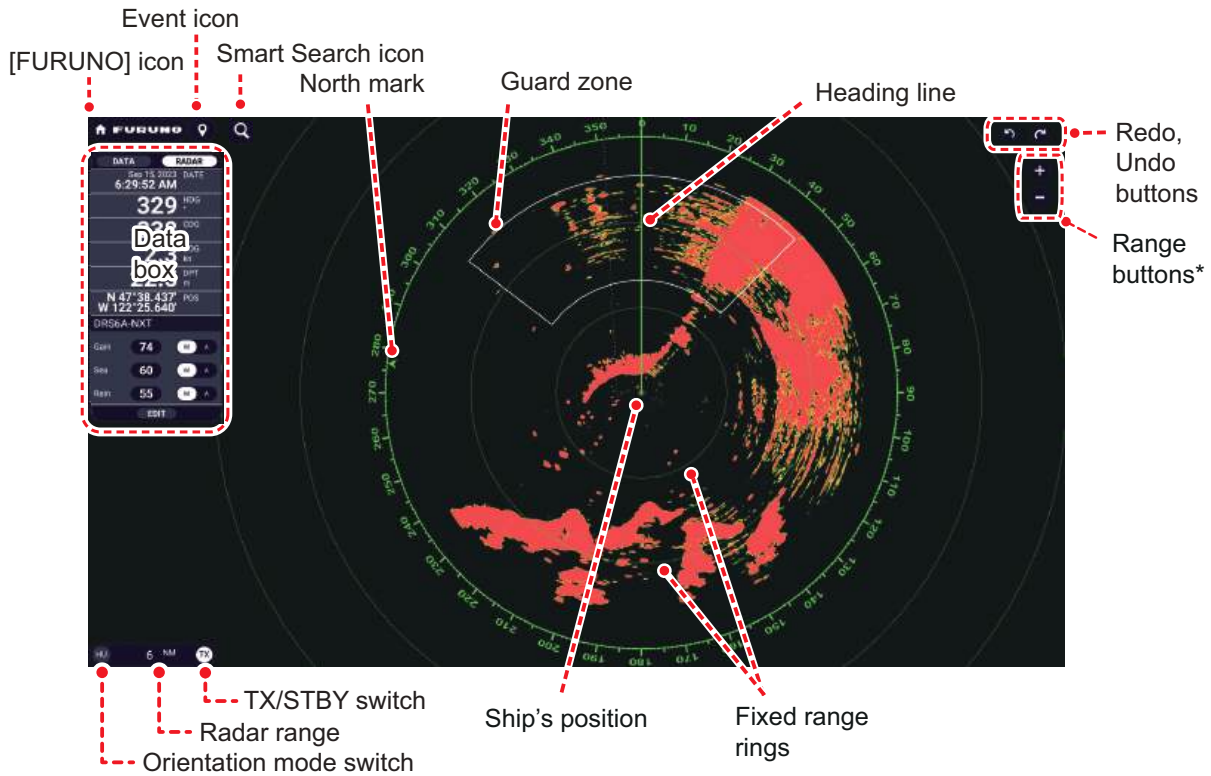

*: When the [Show Range Slider] setting is turned on, the slider bar appears between the range (zoom in/out) buttons.

1.15 Settings Menu

The [Settings] menu provides the options for customizing your system. The [Settings] menu, as well as all other items on the Home page, is automatically closed, and the previous operation display restored, when no operation is detected for approx. one minute.

1. Tap the [FURUNO] icon to go to the Home page.
2. Tap [Settings].

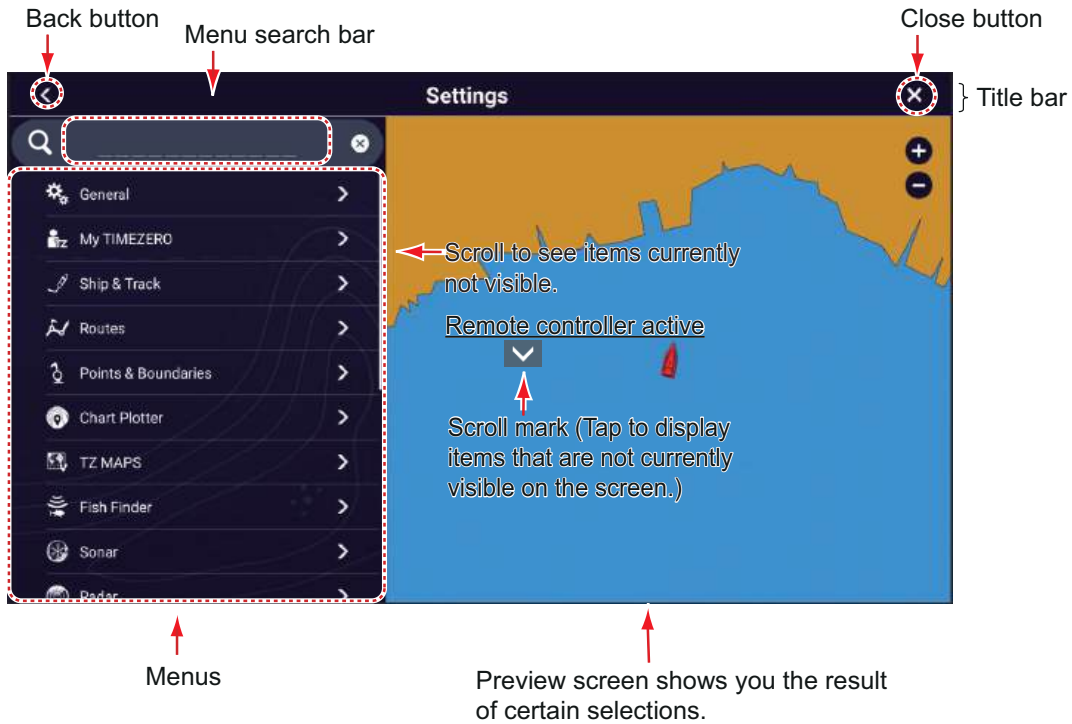

3. Drag the menu displayed on the left side of the screen up or down to locate desired menu, then tap the menu name, A sub menu appears.

Note: Use the menu search bar to search menus. This is only shown on the setting menu, not shown on the sub menus.

 - 1) Tap the menu search bar to show the software keyboard at the bottom of the screen (see page 1-34).



Tap to hide software keyboard.

- 2) Enter characters or numbers. The related menu options appear.
- 3) Select the desired menu.
4. Do one of the following according to the menu item:
 - **On/Off flipswitch:** Tap the flipswitch to switch between On and Off.

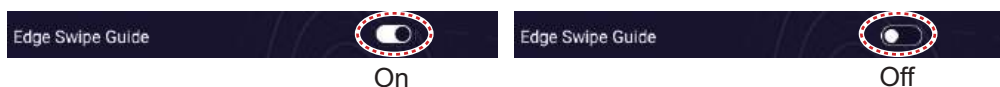

1. SYSTEM INTRODUCTION

- **Slider bar, keyboard:** Set level by using the slider bar, or tapping the keyboard icon (📄) to enter the level with the numeric software keyboard. (See the next page for the appearance of the numeric keyboard.)



- **Alphabet, numerical data entry:** A menu item that requires entry of alphabet and/or numerical data has a keyboard icon (📄). Tap the keyboard icon to show the keyboard. (The keyboard displayed depends on the item selected. Some items provide only the numeric keyboard.) Enter data, then tap [✓] to confirm.

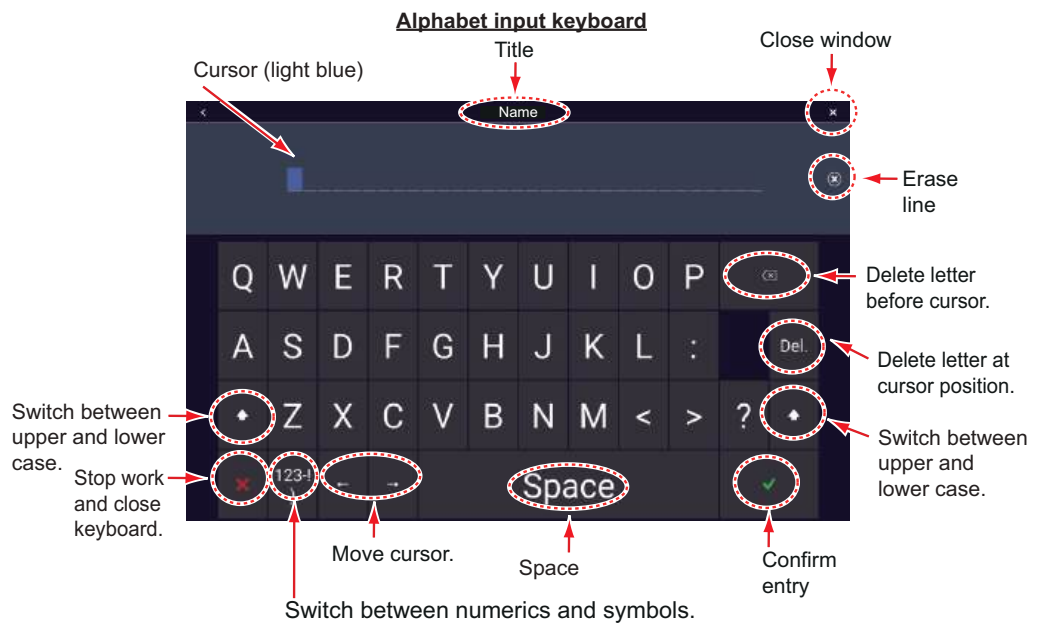

*
 ⇩ : Lowercase input. Tap to switch to uppercase input.
 ⇧ : Uppercase input. Tap to switch to lowercase input.
 ⇧ : Uppercase input. Tap to switch to lowercase input.

Numeric input keyboard

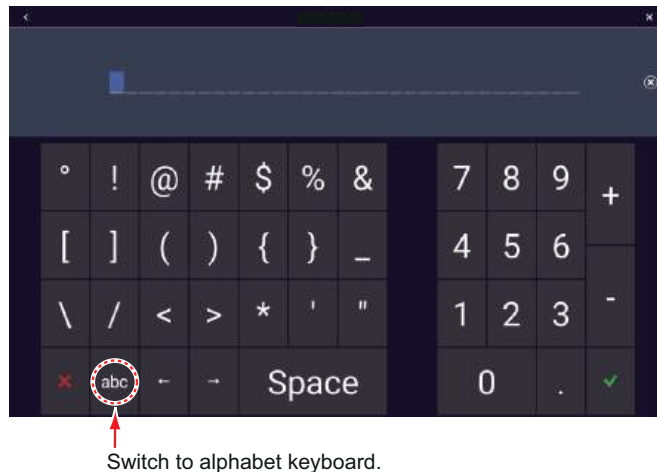

- **Option selection:** The option displayed to the left of [>] is the currently selected option. Tap an item to see other choices. The item highlighted in light blue or marked with [✓] is the currently selected option.

Color selection

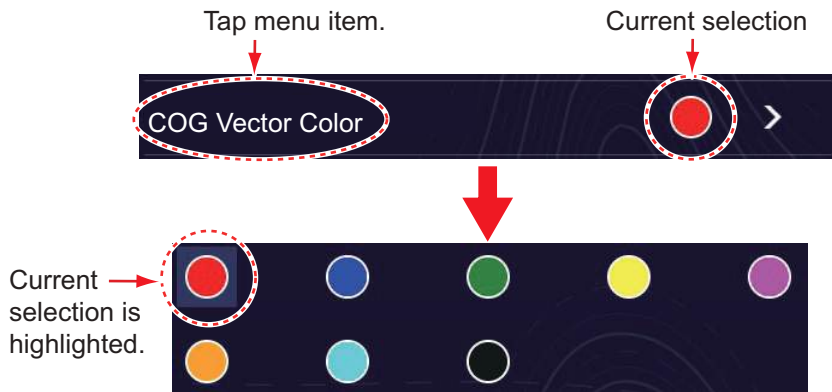

Selection other than color

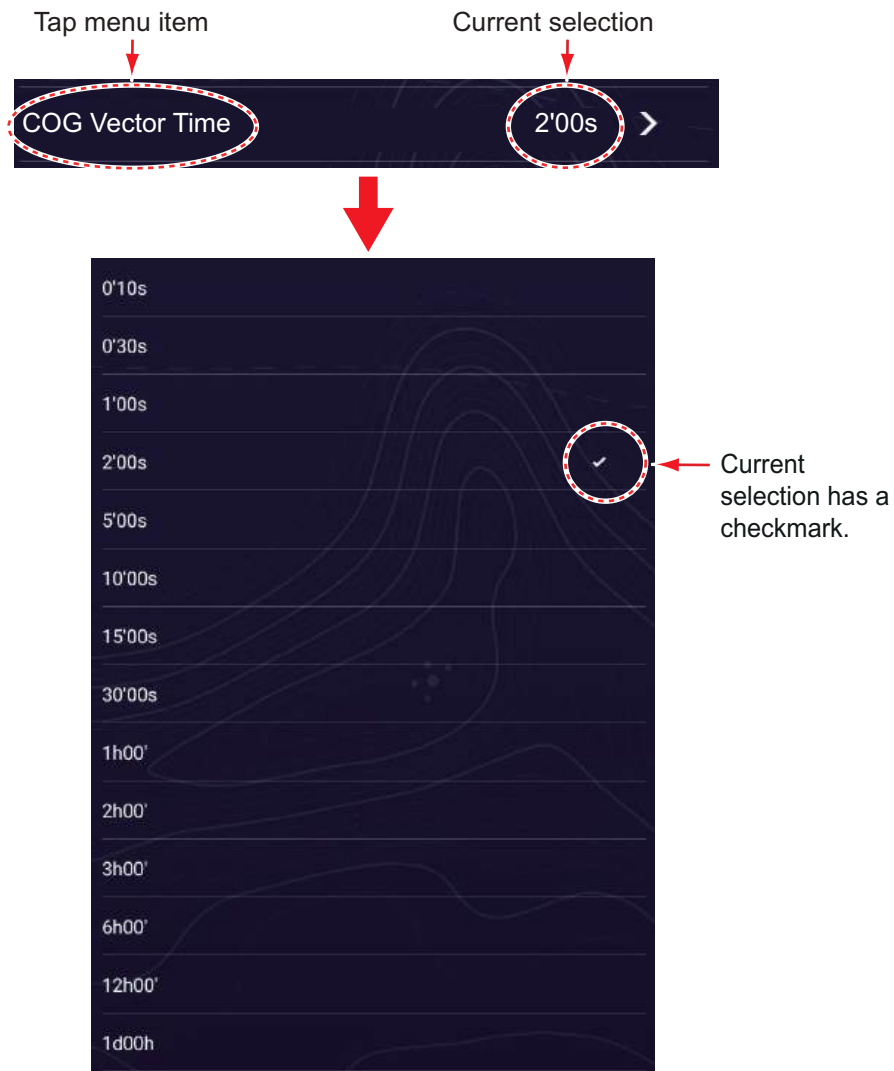

5. Tap [x] on the title bar to finish and close the menu.

1.16 Two-Finger Tap Function

You can assign shortcut functions to tap and long tap operations performed with two fingers. Set the shortcut function as shown below.

1. Home page→[Settings]→[General]→[This Display]→[Two Finger Tap Function] or [Two Finger Long Tap Function].

2. Tap a function among the following:

[None]: Function disabled.

[Full Screen]: On a split screen, the tap function makes the active screen a full screen. Tap the screen again to revert to the split screen.

[Screen Capture]: Capture the screen and save it to the storage media connected to the USB port. After the screen is copied, the message "Screenshot taken" appears for three seconds. The chart plotter display shows the photo icon ()

at the geographical position where the screen was captured. The file name is automatically recorded, with the date and time the screenshot was taken and the .png extension. To move, edit, delete a photo icon, tap it to show the Pop-up menu, then take the appropriate action. If you are using the TZ First Mate™ feature, the screenshot can be seen on a smartphone, tablet.

[Event Window]: Records an event. The [Creating Events] Pop-up menu appears. Tap a mark, and an event mark is placed at own ship position (see subsection 4.2.2).

[Event Mark 1], **[Event Mark 2]**: Places the event mark specified for Event Mark 1(2) at own ship position.

[MOB]: Places a MOB mark at own ship's position.

[Home]: Opens the Home page (see section 1.5).

[Settings]: Opens the [Settings] menu (see section 1.15).

[Lists]: Opens the [Lists] menu (see section 1.5).

[Tide]: Opens the tide graph (see subsection 3.2.5).

[Gain Control]: Displays the gain adjustment slider bar in the radar, fish finder, multi beam sonar mode. Refer to section 7.4, subsection 6.6.2, subsection 9.4.6, subsection 9.5.8.

[Anchor Watch Alarm]: Turns the anchor watch alarm on or off (see subsection 2.12.6).

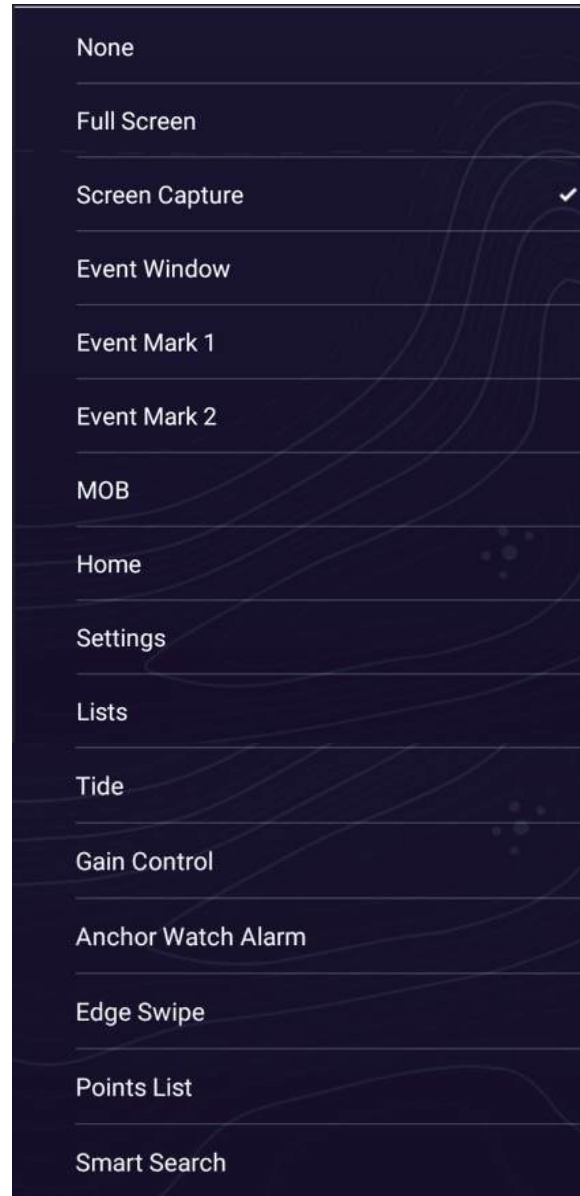

[Edge Swipe]: The arrow keys shown in the below figure appear on the screen. While displayed, you can “edge swipe” with the MCU-005/006/006H’s EDGE key Cursorpad, or Scrollpad.

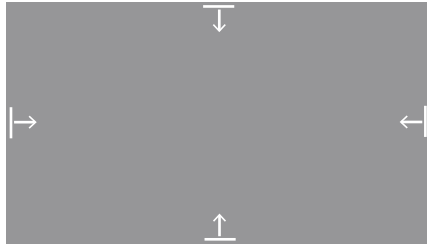

[Points List] Opens the points list (see section 4.7).

[Smart Search] Opens the Smart Search display (see section 2.8).

[Fusion]: Opens the Fusion screen (see section 12.1. Shown when Fusion equipment is connected).

[Fusion Bar]: Shows the Fusion operation bar (see section 12.2). Shown when Fusion equipment is connected.

3. Tap [x] on the title bar to finish and close the menu.

1.17 Event Icon (long) Tap Operation Function

The function of the event icon (long) can be changed as shown below.

1. Home page→[Settings]→[Points & Boundaries]→[Events]→[Event Button Short Tap] or [Event Button Long Tap].

2. Select one of the following:

- **[Event Window]**: The [Creating Events] window (see section 4.2.2) appears. Tap an event mark to put it at own ship position.
- **[Event Mark 1], [Event Mark 2]**: Puts event mark 1(2) at own ship position.
- **[Screen Capture]**: Takes a screenshot. The screenshot is saved to the storage media connected to the USB port and the internal memory. After the screenshot is taken, the message "Screenshot taken" appears for three seconds, and the photo icon () is put at the position of your ship at the moment the screenshot was taken. A file name is automatically assigned and saved to the [Photos] list. You can tap the photo icon to move, edit, or delete the icon. This photo can also be viewed on smartphones and tablets by using the TZ First Mate feature (see section 2.18).
- **[Anchor Watch Alarm]**: Turns the anchor watch alarm on or off. (See subsection 2.12.6.)
- **[MOB]**: Puts the MOB symbol at the position of your ship at the moment the event icon is (long) tapped.
- **[Points List]**: Opens the points list (see section 4.7).

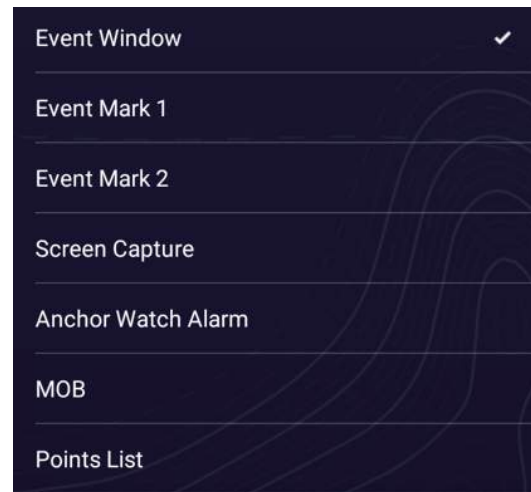

1.18 Language

The default interface language is English (United States). To change the language, do as follows:

1. Home page→[Settings]→[General]→[Language].
2. Tap the language to use. The message "APPLICATION HAVE TO RESTART NOW! DO YOU WANT TO RESTART APPLICATION?" appears.
3. Tap [OK]. It takes approximately five minutes to optimize the system for the new language setting,

1.19 Man Overboard (MOB)

The MOB function is used to mark the location of man overboard, from the chart plotter and radar displays. At the moment the MOB function is activated, the MOB mark is put at the current position, on both the chart plotter and radar displays.

How to mark the MOB position

Tap [MOB] on the Home page. The chart plotter display opens, the MOB mark () is put at the location at the moment MOB was activated, and the MOB location is automatically set as destination.

At the moment of activation the following occurs.

- The message "MOB" flashes in the Status bar, with yellow characters on a red background. The aural alarm sounds if it is enabled. Tap the Status bar to stop the flashing indication and silence the aural alarm.
- The MOB mark is highlighted.
- A yellow line connects between the MOB mark and current location. This line shows the straightest course between own ship and the MOB mark.

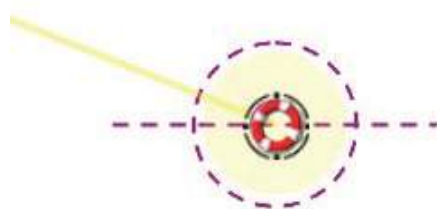

MOB mark on the chart plotter display

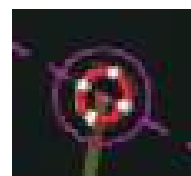

MOB mark on the radar display

MOB marks are automatically saved to the Points list (chapter 4).

MOB information

Tap a MOB mark to display the following MOB data: latitude, longitude, DTA (distance to the MOB), ETA (Estimated Time of Arrival at the MOB), depth*.

*: Depth data requires a depth sensor.

How to delete a MOB mark

Tap a MOB mark to display the Pop-up menu, then tap [Delete] to delete the mark. However, if the MOB position is set as destination, the MOB point (highlight) cannot be deleted and the destination is not canceled. To erase a MOB mark set as a destination, you must first stop navigation to the MOB. Tap the MOB mark, select [Stop Nav] (to cancel the destination) from the Pop-up menu, tap the mark again, then tap [Delete].

1.20 Wireless LAN Settings

You can connect to the internet via the built-in wireless LAN to download weather information, confirm software version, update the software, and purchase TZ MAPS. Further, you can use a tablet to operate or monitor the TZMAP9/13 or TZT9E/13E.

The wireless LAN can be used two ways:

- **Use existing LAN:** Connect to an existing LAN access point (in a harbor, etc.) to download weather information.
- **Create local network:** Create an access point from which the TZMAP9/13 or TZT9E/13E can be monitored and controlled from a smartphone or tablet.

About the wireless LAN

- The wireless LAN function is available only in the countries that have acquired radio wave certification. Turn this function off in countries that do not have radio wave certification. Ocean-going vessels that have radio wave certification can use the wireless LAN function in any country that has acquired radio wave certification. Vessels with radio wave certification that enter a country that does not have radio wave certification may use the wireless LAN function only onboard the vessel.
Available countries (as of 02/2024): USA, Canada, New Zealand, Australia, Japan, and all countries of the EU.
- The communication rate and effective range for the wireless LAN can be affected by electromagnetic waves, interfering objects, or access point location.
- We strongly recommend using the wireless LAN with encrypted connection. Otherwise unauthorized access by a third party can occur, which can cause loss of data or system crash.
- We recommend changing the initial password before using a local wireless network.

1.20.1 How to connect the existing LAN

1. Home page→[Settings]→[General]→[Connectivity]→[Wireless LAN Settings]→[Wireless Mode].

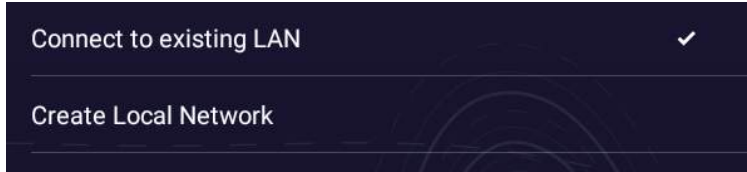

2. Tap [Connect to existing LAN], then tap [<] to go back one layer in the menu.
3. Turn on [Wireless] to see the available WLAN networks, at the bottom of the screen.

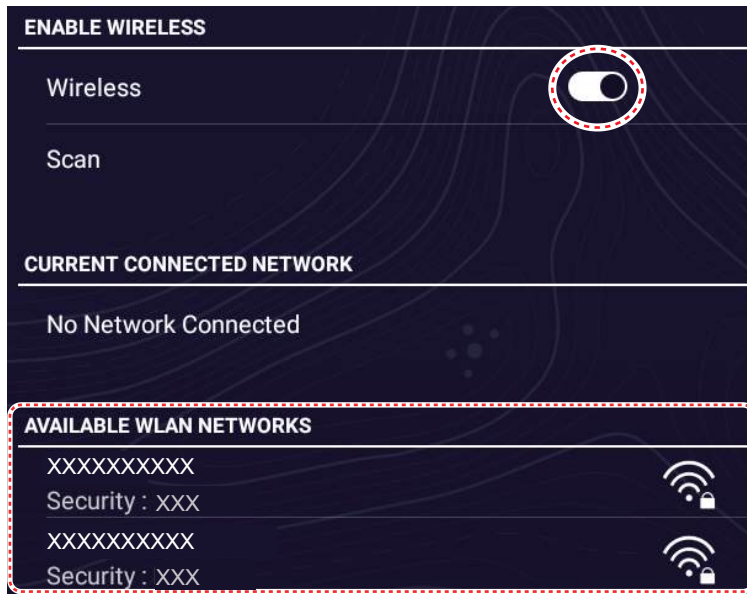

4. Tap the network to use, and the following window appears.

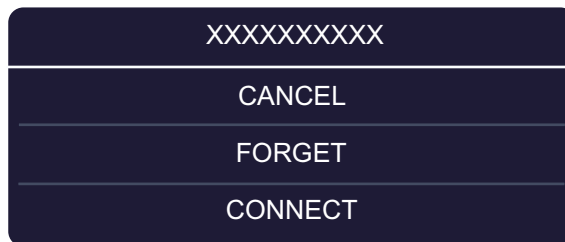

- Tap [CONNECT] to show the [Enter Wireless Network Key] window.

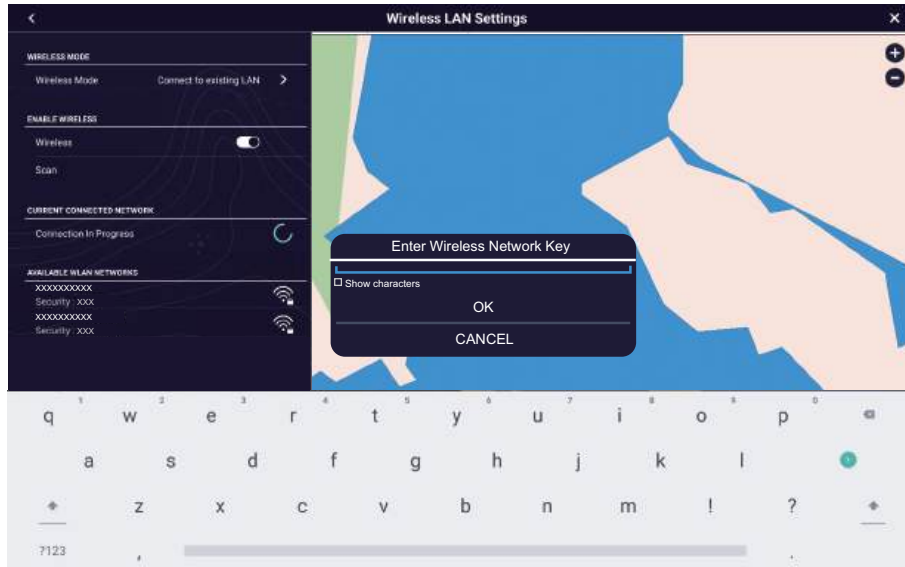

- Enter the network key, then tap [OK].
If the connection was successful, the network details appear below [CURRENT CONNECTED NETWORK].
Note: If the network key is incorrect, an error message appears. Tap [OK], then tap the network again and select [FORGET] (see step 4). Enter the correct network key, then tap [OK].
- Tap [x] on the title bar to finish and close the menu.

1.20.2 How to create a local wireless network

Note 1: Do the procedure with [Local Network] in [Wireless LAN Settings] turned off.

Note 2: It may not be possible to connect to a local network if the network is unstable. In this case, turn [Wireless] off and on. Connect via existing LAN network.

- Home page → [Settings] → [General] → [Wireless LAN Settings] → [Wireless Mode].
- Tap [Create Local Network], then tap [<] to go back one layer in the menu.

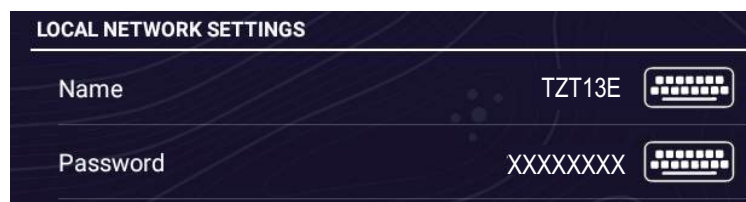

- Tap [Name].
- Enter the name of the network, then tap [✓].
- Tap [Password].
- Enter the password, then tap [✓]. (If the password is wrong, an error message appears. Tap the [OK] button, then reenter the password.)

Note: Avoid following actions to keep your data safe.

- Do not write down your password (for example, to a piece of paper) and keep it near to the equipment.
- Do not set the same password for the PIN Code Lock and local wireless network (see section 1.22).
- Do not share the password with other users.

1. SYSTEM INTRODUCTION

- Do not keep the same password for a long period. Change the password regularly.
7. Turn on [Local Network] in [Wireless LAN Settings] to connect to the network.
 8. Tap [×] on the title bar to finish and close the menu.
 9. Connect to TZT9E/13E or TZMAP9/13 from the NavNet app on your tablet or smartphone.

Note: For settings on smartphones and tablet devices, please refer to their respective instruction manuals.

1.21 How to Create and Login to Your My TimeZero™ Account

You will need to create a My TimeZero™ account to access the cloud and Fleet functions. Prepare a PC or mobile device to complete the registration. Make sure the system has the correct time/date as TimeZero™ cannot function without correct time/date.

1. Connect your TZT9E/13E or TZMAP9/13 to the internet. See section 1.20.
2. Home page→[Settings]→[My TIMEZERO],
3. Select [Login].

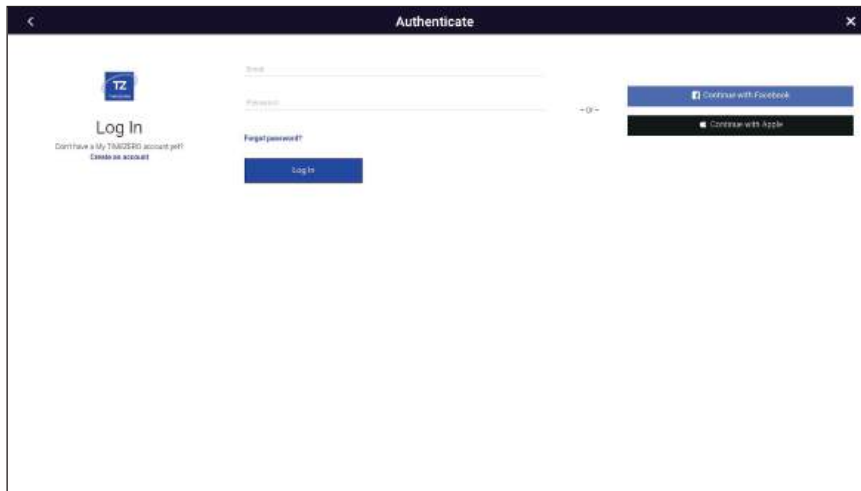

Note: You can also login with your Facebook or Apple account.

4. Tap [Create an account].

1

5. Fill in all fields.
6. Check the checkbox to confirm and agree with term of use.
7. Click [Get started!] to finish and close the window.

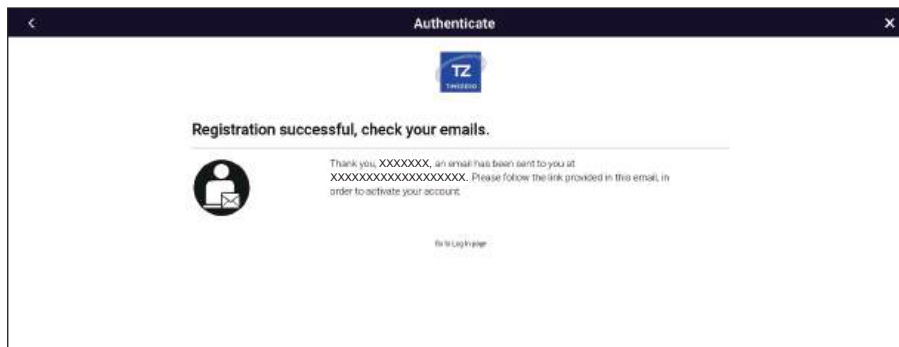

8. From a PC or mobile device, follow the link provided in the e-mail to log into your account. Leave the TZMAP9/13 or TZT9E/13E as is.
9. Tap [Go to Log in page] on this equipment.

10. Enter the e-mail address used to register the account and your password.
11. Tap [Log in].

The name used to create the account appears in the [Logged As] field. The Status bar shows (in yellow) "You are logged as (your name)" and several beeps sound (if alarm sound is turned on).

Note: When the [Settings]→[My TIMEZERO]→[Report Usage Statistics to My TIMEZERO] is set to on, the usage data is collected in the background and sent to My TIMEZERO™ server for future product development.

1.22 PIN Code Lock

The PIN code lock feature allows you to require a six-digit password to be entered upon startup, keeping your data safe against theft. Settings that require password input are masked with a lock icon. Follow the procedure below to set the password.

Note 1: Avoid following actions to keep your data safe.

- Do not write down your password (for example, to a piece of paper) and keep it near to the equipment.
- Do not set the same password for the PIN Code Lock and local wireless network (see section 1.20.2).
- Do not share the password with other users.
- Do not keep the same password for a long period. Change the password regularly.

Note 2: Passwords cannot be reissued. Keep a note of your password and store it in a safe place. If you have forgotten your password, contact place of purchase, or the nearest FURUNO branch or sales office to request password unlock. Once unlocked, you need to restore it to factory default. Data such as points, routes, tracks, etc. are erased and cannot be recovered.

Note 3: Set a password for each MFD (Multi Function Display) in the network.

1. Open the [Settings]→[General]→[This Display].
2. Turn on the [Password Lock at startup].
You will use this password to unlock this display unit at the system startup. Write down the password and keep it in a safe place. If you forgot the password, the unit cannot be unlocked. Request a FURUNO dealer to unlock the unit. After the unit is unlocked, all factory settings are restored, meaning all your user data (points, routes, tracks, boundaries, catches, photos, settings) will be lost.
3. Tap [OK] to show the password input screen.

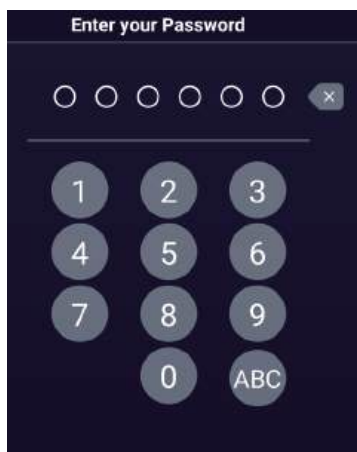

4. Enter your six-digit password. You are asked to confirm the password.
5. Re-enter your password. The message "Password protected" appears.
6. Tap [OK] to finish and close the menu.

To release password protection, turn off [Password Lock at startup] in the above procedure. The message "The password will removed and all units in the network will no longer be protected. Are you sure you want to proceed?" Tap [OK].

How to change the password

Note: The password can be changed only when the [Password Lock at startup] function is enabled.

1. Open the Home page→[Settings]→[General]→[This Display]→ [Change Password].
2. Enter the current six-digit password to unlock the password protection.
3. Tap the [Change Password] again.
4. enter the new six-digit password.
5. enter the new password again to confirm. The "Password protected" pop-up screen appears.
6. Tap [OK] to complete.

1. SYSTEM INTRODUCTION

This page is intentionally left blank.

2. CHART PLOTTER

This chapter covers these items:

- Use of chart-related functions
- Chart plotter related alarms
- Track control

2.1 Chart Plotter Layers Menu

The chart plotter display mode has three types of Layers menus.

[Charts] tab: Provides selection of charts, 3D data source, and turn depth shading, depth contours, etc. on or off.

[Overlays] tab: Shows or hides various overlays, turns the risk visualizer, avoidance route on or off.

[User Objects] tab: Turns user objects, such as tracks and points, on or off.



[Charts] tab

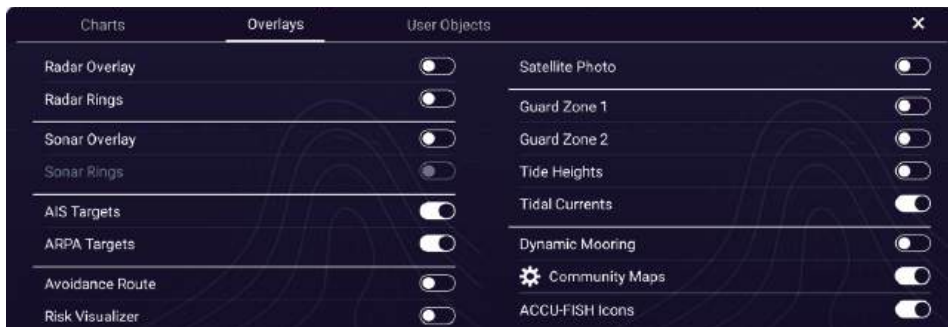

[Overlays] tab

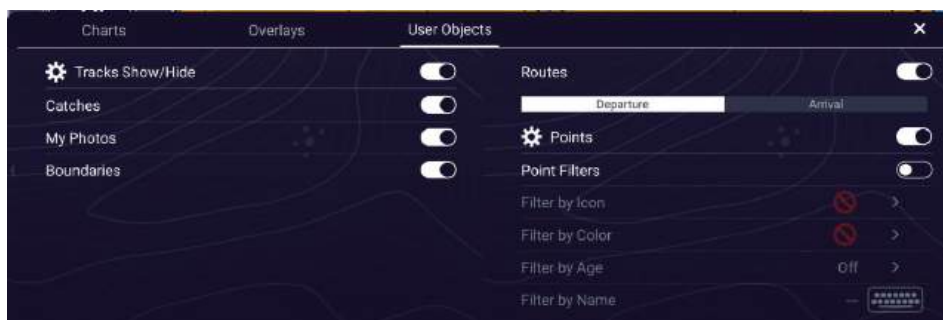

[User Objects] tab

2.2 Chart Type

The supplied microSD card contains the following MM3D charts:

- **Raster chart:** A simple map that is an electronic version of paper and paper-like charts. Detailed data is not provided.
- **Vector chart:** Electronic data for displaying the main information necessary for a voyage. It is not equivalent to a paper chart.
 - **S57:** Vector chart compliant with S57 standards.
 - **BathyVision:** A vector chart for fishing, with detailed depth display.

Note 1: Insert the included microSD card into its card slot before turning on the power (see section 1.11).

Note 2: TZ MAPS are available for purchase (see section 16.6.1).

How to select a chart type

1. Go to the Home page, then tap the chart plotter display icon.
2. Open the Layers menu.
3. On the [Charts] tab, select [TZ MAPS] or [MM3D].
4. For [TZ MAPS], select [TZ Vector], [TZ Raster], or [TZ BathyVision]. In case of [MM3D], select [Auto], [S57], [C-MAP], [Navionics], or [Raster].

How to select the source for the depth contours

Note: This feature is disabled when the chart type [TZ MAPS] is selected to [TZ BathyVision].

1. Go to the Home page, then tap the chart plotter display icon.
2. Open the Layers menu.
3. On the [Charts] tab, [3D Data Source] item, tap [HR Bathy], or [MM3D].
 - [HR Bathy]: TZ vector bottom data.
 - [MM3D]: MM3D bottom data.

2.3 Range Zoom In, Zoom Out

You can zoom in and zoom out around a specific position. The range is displayed with the scale bar at the bottom left corner of the chart plotter display.

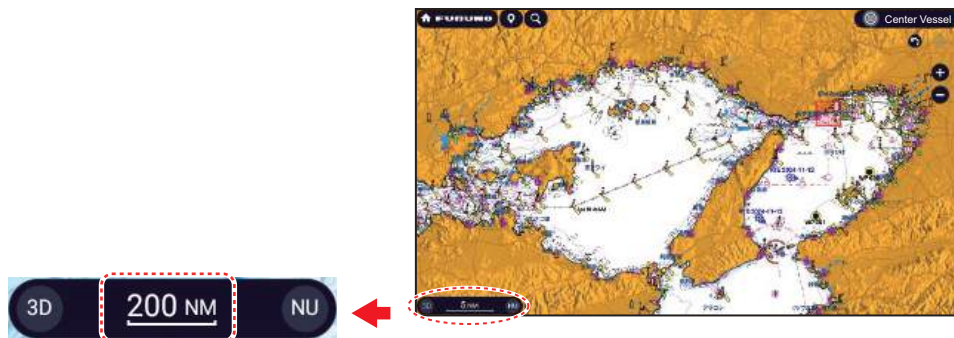

How to zoom in or out the display range

Method 1: Pinch the chart plotter display.

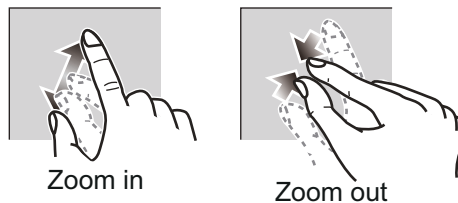

Method 2: Operate the range buttons (+, -).

Tap the range buttons (+, -). The buttons can be shown or hidden. Home page → [Settings] → [Chart Plotter] → [Show Range Buttons].

Method 3: Operate the range slider bar.

Drag the slider thumb shown on the right-hand side of the screen, tap the slider bar, or tap the range buttons (+, -). Set the range slider bar to on/off on the [Settings] → [Chart Plotter] → [Show Range Slider] menu.

Note 1: When a raster chart is displayed, you can see whether the appropriate range is set by the display color of the scale bar displayed at the bottom left corner of the screen.

- **White:** Range is appropriate for chart accuracy.
- **Red:** Range is inappropriate for chart accuracy.

Note 2: You can zoom the display range in or out from the preview screen.

Note 3: When the range buttons, or the range slider bar is set to on, they are shown only on the active display of the multi-split screen.

2.4 Orientation Mode

The chart can be shown in head-up or north-up orientation. Tap the orientation mode switch, [HU] or [NU], whichever is shown, at the bottom left corner to change the orientation mode.

- **North Up:** North is at the top of the screen. When your heading changes, the vessel icon moves according to heading. This mode is useful for long-range navigation.
- **Head Up:** Displays the chart with the current compass heading of your ship at the top of the screen. The heading data from a compass is required. When the heading changes, the vessel icon remains fixed, and the chart picture rotates according to heading.

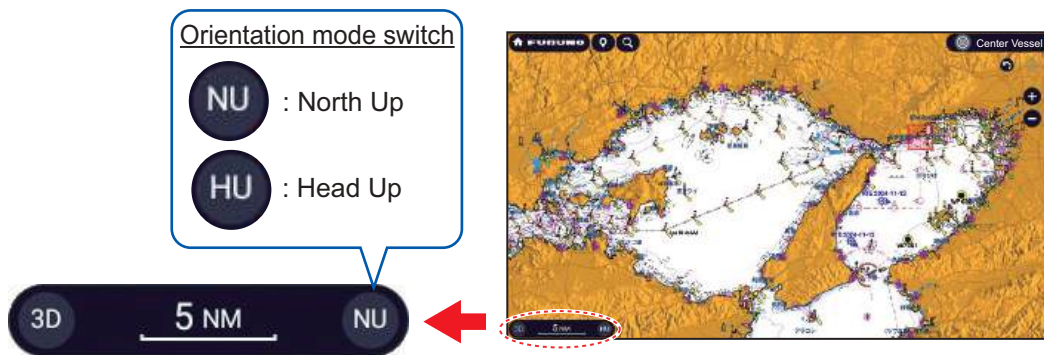

2.5 How to Move the Chart

You may need to move the chart when the vessel icon is off-screen, you want to view an area off-screen, or enter a mark off-screen. The chart must be moved to do those functions.

To move the chart, drag the on-screen display to show the area you want to work with.

Note: To return the vessel icon to the center of the display and show the immediately surrounding area, tap the [Center Vessel] button at the top-right corner of the display.

2.6 The Vessel Icon

2.6.1 Description

The vessel icon (red) marks current position and moves according to your vessel's movement. The following information also appears with the vessel icon.

- **Heading line:** A straight line that runs from your position and shows the current heading.
- **COG vector:** A vector line that runs from the vessel icon and points in the direction in which your ship is now moving.
- **Turn direction indicator:** An arrow points in the direction your vessel is turning, starboard or port. In the figure above, the turn indicator is pointing in the starboard direction.

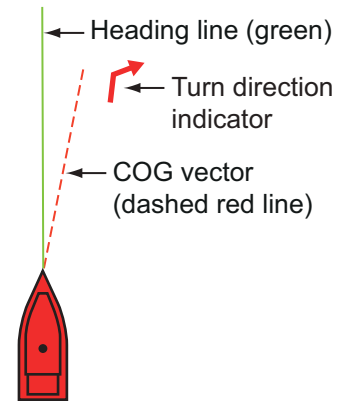

2

2.6.2 How to show or hide the COG vector, heading line

Tap the vessel icon to show the Pop-up menu.

Turn [COG], [HDG] on or off as required. The turn direction indicator is also turned on or off with [COG].

Note 1: The color of the COG vector (including the turn direction indicator) can be changed. Home page → [Settings] → [Ship & Track] → [OwnShip] → [COG Vector Color].

Note 2: The thickness of the heading line can be changed. Home page → [Settings] → [Ship & Track] → [OwnShip] → [Heading Line Thickness]. Set the thickness with the software keyboard or the slider bar. [1] is thinnest; [5] is thickest.

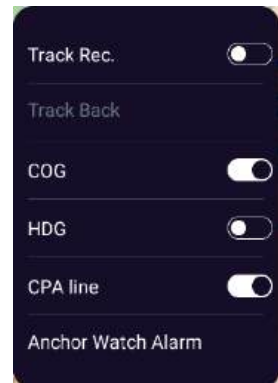

2.6.3 COG vector length

The COG vector can be set to show one of the following:

- Estimated position after traveling the distance set in the menu.
- Estimated position after traveling the time set in the menu.

The tip of the vector is the estimated position of your ship at the end of the selected time or distance. The greater the distance or the time, the longer the COG vector. To change the COG vector length, do the following.

1. Home page → [Settings] → [Ship & Track] → [OwnShip] → [COG Vector].
2. Tap [Distance] or [Time] as required, then tap [<] on the title bar. If you selected [Distance], go to step 3. For [Time], go to step 5.
3. Tap [COG Vector Length] to display the software keyboard.
4. Set the length for the COG vector, then tap [✓]. Go to step 6.

2. CHART PLOTTER

5. Tap [COG Vector Time], then tap the time to use for the COG vector.



6. Tap [×] on the title bar to finish and close the menu.

2.6.4 Vessel icon orientation

You can select the orientation of the vessel icon to heading or COG.

1. Home page→[Settings]→[Ship & Track]→[OwnShip]→[Vessel Icon Orientation].
2. Tap [Heading] or [COG].
3. Tap [×] on the title bar to finish and close the menu.

2.7 How to Find Information Chart Object and Chart Information

You can find chart object and chart information from the Pop-up menu.

2.7.1 Chart object information

Simple information

Tap an object to show its name, specifications, position, and range and bearing, in the Pop-up menu.

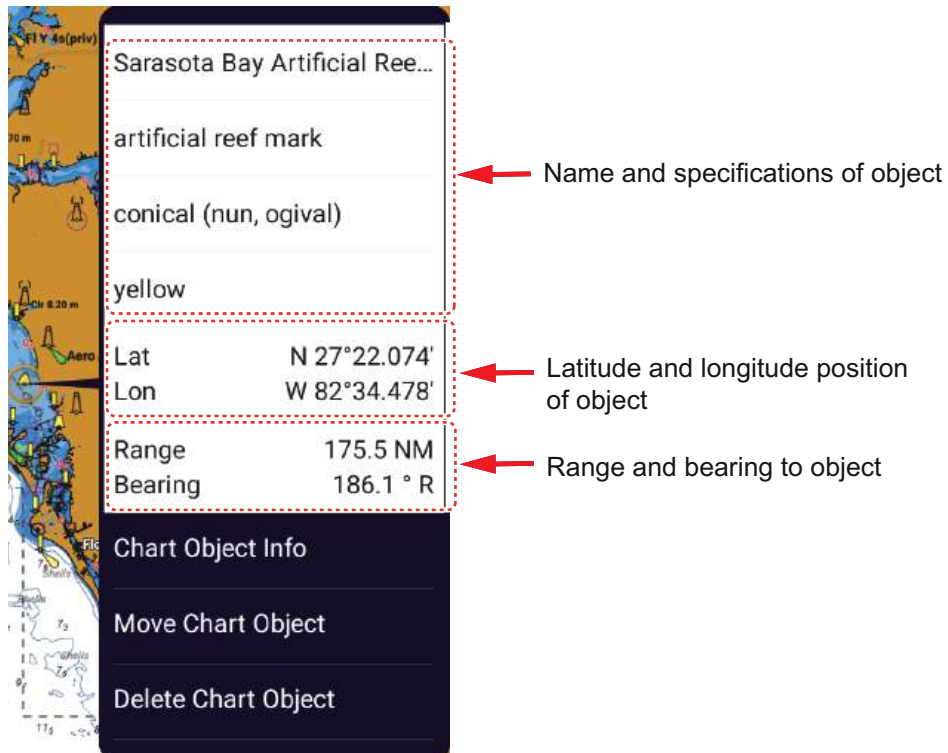

2. CHART PLOTTER

Detailed information

Tap an object to show the Pop-up menu. Tap [Chart Object info] on the Pop-up menu to show detailed information.

BUOY, SPECIAL PURPOSE	
Name	Sarasota Bay Artificial Reef Buoy H
Shape	conical (nun, ogival)
Category	artificial reef mark
Color	yellow
Status	private
Source date	Tuesday, April 17, 2012
Indication	US,US,reprt,7thCGD,LNM 16/12
EDIT	
Update Name	
Comment	
OBSTRUCTION	

2.7.2 Chart information

Tap a location on the chart not occupied by a chart object, then tap [Chart Info] on the Pop-up menu.

CHART INFO	
Chart type	Vector charts
Chart manufacturer	C-MAP
File name	SDVJWW00MAP02.DBV
POINT INFO	
Lat	N 32°29.121'
Lon	E 134°21.987'
Bearing	133 °
Range	76.66 NM
MM3D TILES ID	
R	609
C	894
L	10

2.8 Smart Search Function

Use the Smart Search function to search for routes, AIS, points, tides, marinas, and moorings (harbors). To open the smart search display, use one of the following methods.

- Tap the smart search icon at the top left-hand corner of the screen.
- Open the slide-out menu, and then select [Smart Search].
- Open the Home page, then select [Smart Search].
- Use the two finger tap function (long-tap).

Note: To open the smart search display with two finger tap function, set [Two Finger Tap Function] or [Two Finger Long Tap Function] for [Smart Search] (see section 1.16).

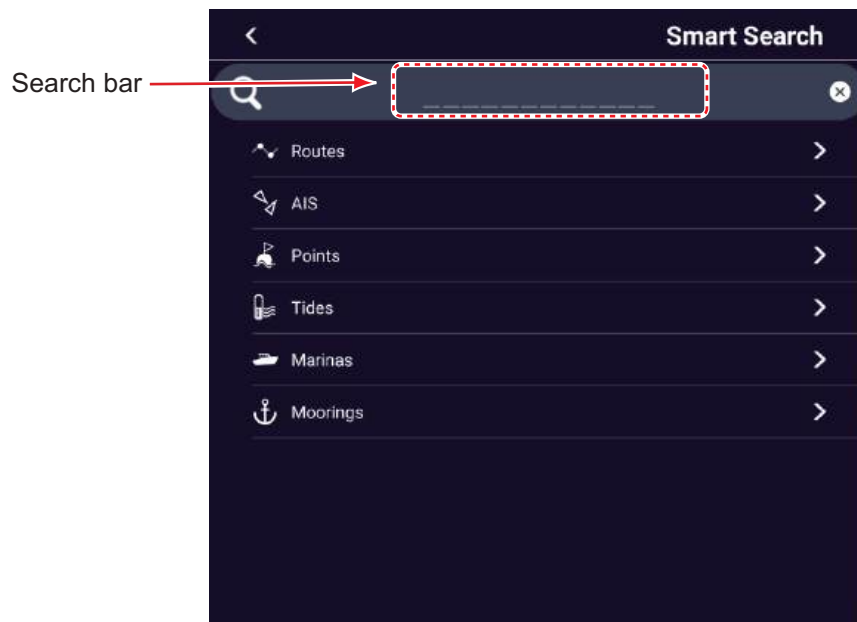

Do the following to search menus (only characters and numbers can be entered).

1. Tap the search bar. If you have a specific category (routes, AIS, points, tides, marinas, or moorings), tap the category, then tap the search bar. A software keyboard appears at the bottom of the screen (see page 1-34).
2. Enter characters or numbers to show a list of related items.

Note: Enter at least three characters or numbers.

To sort the list, tap the sort button at top left-hand corner of the screen (see section 4.7, section 5.4, or section 15.9). The displayed sort button varies depending on the selected category.

- **[Relevance]:** Sort by the most related items.
- **[Name]:** Sort by the name, in alphabet order (tap the button to change the alphabet order).
- **[Range]:** Sort by range from own ship, from nearest to farthest/farthest to nearest (tap the button to change the order).
- **[Color]:** Sort by color (tap the button to change the order).
- **[Length]:** Sort by route length, from shortest to longest/longest to shortest (tap the button to change the order).

2. CHART PLOTTER

- **[Date]:** Sort by date registered, in oldest-to-newest/newest-to-oldest order (tap the button to change the order).
 - **[CPA]:** Sorted by CPA in ascending/descending order (tap the button to change the order).
3. Tap the desired item to show the details of the selected item.

2.9 How to Find the Range and Bearing Between Two Locations

The [Distance] item in the Slide-out menu measures the range and bearing between any two locations on your chart. Range and bearing between the two locations are digitally indicated on the screen.

1. Open the Slide-out menu.
2. Tap [Distance].
A dashed line runs between the start location and the 2nd location. The range, bearing, SOG, and TTG to the 2nd location is shown at the top of the screen.

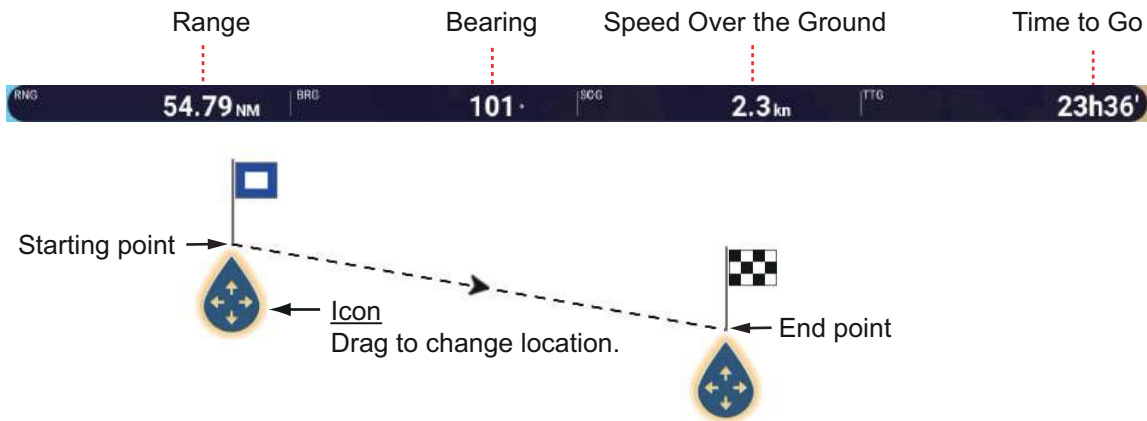

3. To change the location of either point, drag and drop the appropriate icon.
4. To quit the distance measurement, tap [Cancel Ruler] at the top right-hand corner of the screen.

2.10 Multiple Chart Plotter Displays

As many as four chart plotter displays can be shown on one screen. This arrangement lets you see the conditions around your ship on both short and long ranges and different perspectives. Also, you can see how your ship moves toward your destination from more than one angle. For example, you can show one display in 3D and the other two in 2D.

The following features can be adjusted individually.

- AIS
- ARPA
- Display range (zoom in, zoom out)
- Chart orientation
- Chart type
- Scroll the chart
- Overlays (radar, satellite photo, depth shading, tide icon, tidal current icon, ACCU-FISH™ (see section 6.15), points, routes, tracks)
- 2D, 3D display (The viewing angle and orientation can be set independently on all screens. Additionally, you can also set the display mode independently.)

The following example shows three chart displays with different chart types, ranges, orientations, and perspectives.

Chart plotter display 2

Chart type: MM3D, S57 Range: approx. 5 NM
Orientation: Head up Perspective: 2D



Chart plotter display 1

Chart type: TZ MAPS, TZ Vector Range: 10 NM
Orientation: North up Perspective: 3D

Chart plotter display 3

Chart type: TZ MAPS, TZ BathyVision Range: 2 NM
Orientation: North up Perspective: 2D
Overlay: Depth shading

2.11 TZ MAPS Settings

This section shows you how to use the [TZ MAPS] menu to set up your TZ MAPS charts. To open the [TZ MAPS] menu, Home page→[Settings]→[TZ MAPS].

2.11.1 How to set chart display color theme

1. Open the [TZ MAPS] menu.
2. Tap [Color Theme],



3. Select a color theme referring to the description below.
 - [**Standard**]: TZMAP9/13 or TZT9E/13E unique color theme.
 - [**Official S-52**]: IHO (International Hydrographic Office) guidelines compliant theme.
 - [**Sunlight**]: Optimal viewing in direct sunlight
 - [**SHOM**]: Color theme compliant with the guidelines of the French Hydrographic Association
 - [**CHS**]: Color theme compliant with the guidelines of the Canadian Hydrographic Association.
 - [**NOAA**]: Color theme compliant with the guidelines of the National Oceanic and Atmospheric Administration
 - [**Explorer**]: The sea color is blue.
 - [**Cruise**]: Color scheme optimized for cruising.
4. Tap [×] on the title bar to finish and close the menu.

The [Color Theme] can be also adjusted on the Layers menu.

2.11.2 How to select chart style

1. Open the [TZ MAPS] menu.
2. Tap [Style].
3. Select a chart style referring to the description below.

[**Simplified**]: IHO (International Hydrographic Office) guidelines compliant style

[**Paper Chart**]: Paper nautical chart style

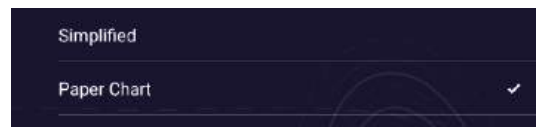

4. Tap [×] on the title bar to finish and close the menu.

2.11.3 How to select land features type

1. Open the [TZ MAPS] menu.
2. Tap [Land Features]

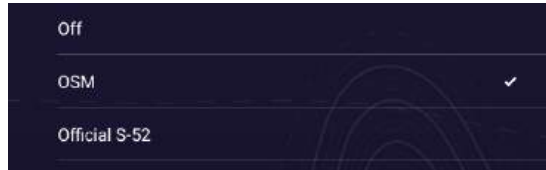

3. Select land features format referring to the description below.
[Off]: Displays the normal chart.
[OSM]: Land features compliant with Open Street Map.
[Official S-52]: Land features compliant with IHO.
4. Tap [×] on the title bar to finish and close the menu.

2

2.11.4 How to set object size

1. Open the [TZ MAPS] menu.
2. Use the slider bar for [Object Size], or tap the software keyboard icon to enter size with the software keyboard to set size (setting range: 50% to 150%).
Note: The text font size does not change. To change the text size, select Home page→[Settings]→[General]→[This Display]→[Plotter Objects Size].
3. Tap [×] on the title bar to finish and close the menu.

2.11.5 How to set safety depths

1. Open the [TZ MAPS] menu.
2. At [SAFETY DEPTHS], tap [Shallow Water].
3. Set the shallow water depth.(0 to 10 m, 11 increments). The depth from 0 m to the set depth is shown in dark blue.
4. Tap [<] on the title bar to return to the [TZ MAPS] menu.
5. Tap [Safety Water]
6. Set the safety water depth.(0 to 50 m, 15 increments). The depth set with [Shallow Water] to the set safety water depth is shown in light blue.
7. Tap [<] on the title bar to return to the [TZ MAPS] menu.
8. Tap [Deep Water].
9. Set deep water depth.(0 to 500 m, 19 increments). The depth set with [Safety Water] to the set deep water depth is shown in white.
10. Tap [×] on the title bar to finish and close the menu.

2.11.6 Control visibility of text and object information in vector charts

The [TZ MAPS] menu controls the visibility of text and object information. Set up text and object visibility referring to the description below.

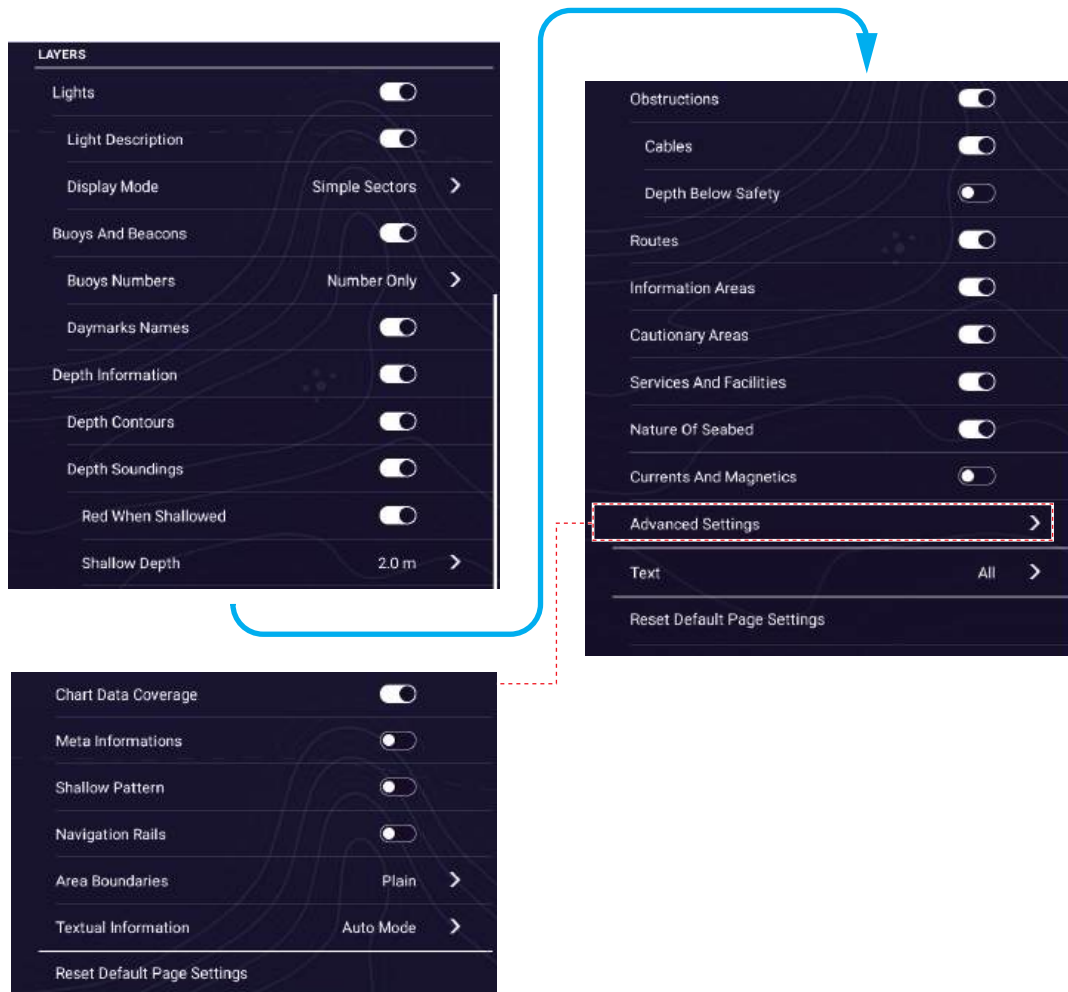

[Lights]: Show or hide the sector of light that a fixed beacon shines.

[Light Description]: Show light description text.

[Display Mode]: Select the light display mode, [Simple Sectors] or [Real Range Sectors]. [Real Range Sectors] displays the actual light reach distance.

[Buoy And Beacons]: Show or hide the buoys and beacons.

[Buoy Numbers]: Select the buoy information to show, [Full Name], or [Number Only]. Select [Off] to turn off buoy information.

[Daymarks Names]: Show or hide daymarks names.

[Depth Information]: Show or hide depth information.

[Depth Contours]: Show or hide depth contours.

[Depth Soundings]: Show or hide depth soundings.

[Red When Shallowed]: Show or hide depth information (including contour lines) in red that is less than the value set at [Shallow Depth] below.

[Shallow Depth]: Set shallow depth (0 to 30 m, 14 increments) when [Red When Shallowed] is activated.

[Obstructions]: Show or hide obstructions (wrecks, etc.).

[Cables]: Show or hide underwater cables.

[Depth Below Safety]: Show or hide obstruction depths under the safety depths.

[Routes]: Show or hide the marine traffic routes.

[Information Areas]: Show or hide the information areas that appear on the chart.

[Cautionary Areas]: Show or hide cautionary areas.

[Services And Facilities]: Show or hide signal stations, pilot boarding areas, and facilities at ports.

[Nature of Seabed]: Show or hide seabed composition indication, for example, mud, sand, rock.

[Currents and Magnetics]: Show or hide the depth contours, tidal currents and magnetics.

[Advanced Settings]: Show or hide the following objects.

- **[Chart Data Coverage]**: Show or hide chart data (geographical names and map symbols).
- **[Meta Informations]**: Show or hide meta information.
- **[Shallow Pattern]**: Show or hide shallow pattern
- **[Navigation Rails]**: Show or hide maritime traffic route.
- **[Area Boundaries]**: Show boundaries in [Symbolized] or [Plain] format.
- **[Textual Information]**: Show or hide textual information. Show text in [National (local language)], [Information (English)], or [Auto Mode].
- **[Reset Default Page Settings]**: Reset the [Advanced Settings] menu settings to default.

[Text]: Show or hide textual information. Select [Off], [Important Only], or [All].

[XTRA DATA]: If other data is included in the downloaded TZ MAPS database, the name of the data is displayed, Set each data display setting to on or off.

[Reset Default Page Settings]: Reset the [TZ MAPS] menu settings to default.

2.11.7 How to send the TZ MAPS feedback

You can send comments and requests regarding TZ MAPS via the web when the following conditions are met.

- The chart type is set as [TZ Vector], or [TZ BathyVision] (see section 2.2).
 - You are logged into your My TimeZero™ account.
 - A valid e-mail address is entered.
 - More than one letter is entered for a comment (characters or numbers, max. 200 characters).
1. Tap the desired location on the chart plotter display.
 2. Tap [Send TZ Maps Feedback] on the pop-up menu to show the following window.

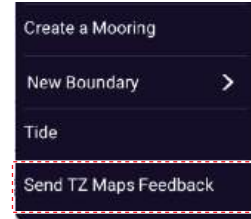
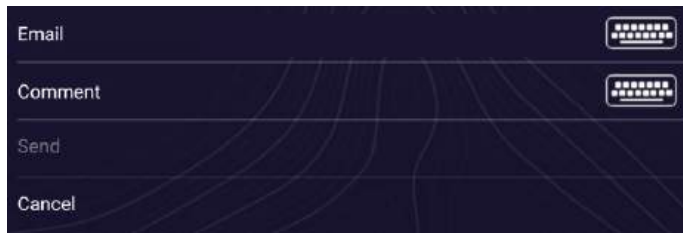

3. The software keyboard is shown. Enter a valid E-mail address.
4. Enter the comment (max. 200 characters).
5. Tap [Send] to send the comment.

2.12 Alarms

The various chart plotter alarms alert you (with audiovisual alarms) when the conditions specified are met. These alarms are:

- Anchor watch alarm
- Boundary alarm (see section 4.18.9)
- Cross track error alarm
- Depth alarm
- Low fuel alarm
- Sea surface temperature alarm
- Speed alarm
- Wind speed alarm

When an alarm is generated, the name of the offending alarm appears in the Status bar (red background with yellow text) at the top of the screen and flashes. If [Alarm Sound] ([Alarms] menu) is active, the unit beeps.



How to silence the audio alarm

Tap the Status bar. The alarm message stops flashing and the audio alarm is silenced. The alarm message remains on the screen until the cause of the alarm is removed or the alarm is disabled.

Note: If [Sound Alarm Until Acknowledged] in the [Alarms] menu is set to Off, the unit continues to beep until the cause of the alarm is removed.

How to open the [Alarms] menu

Home page→[Settings]→[Alarms].

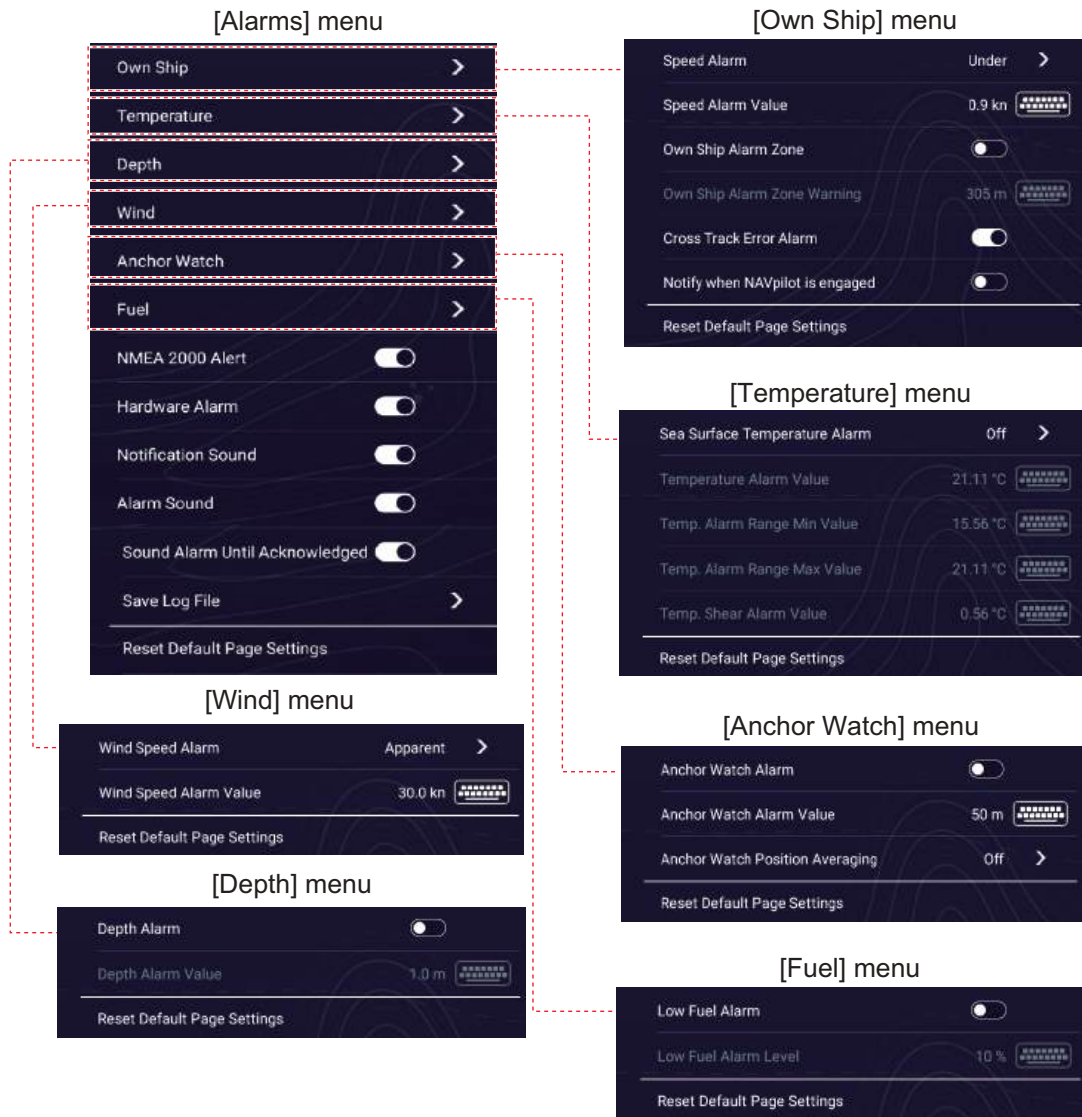

How to reset default alarm settings

Tap [Reset Default Page Settings] on the menu for which you want to reset its default settings.

2.12.1 Cross Track Error alarm

The cross track error alarm tells you when your ship goes off course by more than the limit set.

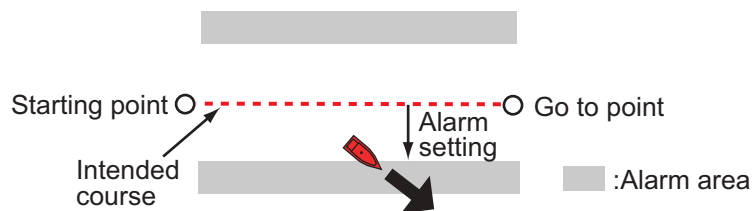

1. Open the [Alarms] menu.
2. Tap [Own Ship] then turn on [Cross Track Error Alarm].

2. CHART PLOTTER

3. Tap [**<**] twice on the title bar to return to the [**Settings**] menu.
4. Tap [**Routes**]→[**Route Settings**]→[**Cross Track Error Distance**] to show the software keyboard.
5. Set the value, then tap [**✓**].
6. Tap [**×**] on the title bar to finish and close the menu.

Note: To disable this alarm, turn it off at step 1 in the above procedure.

2.12.2 Sea surface temperature alarm

The sea surface temperature alarm tells you when the sea surface temperature is over, under, within, or out of range of the temperature you set.

Note: Requires connection to appropriate temperature sensor.

1. Open the [**Alarms**] menu.
2. Tap [**Temperature**]→[**Sea Surface Temperature Alarm**].

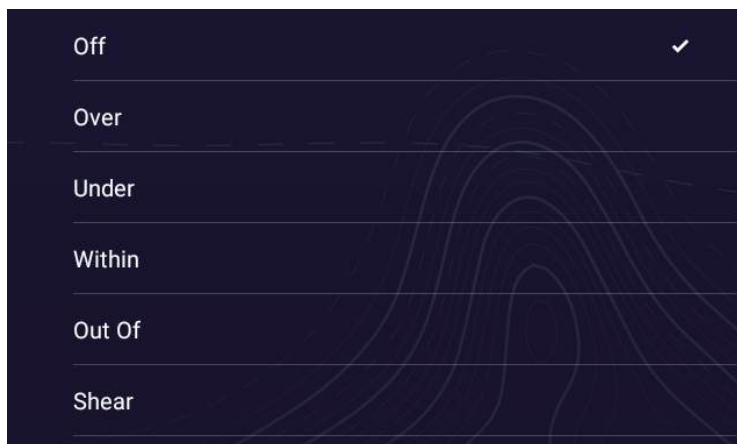

3. Tap the alarm type to use, referring to the description below, then tap [**<**] on the title bar to go back one layer in the menu.
[**Over**]: The alarm sounds when the temperature is over the set value.
[**Under**]: The alarm sounds when the temperature is under the set value.
[**Within**]: The alarm sounds when the temperature is within the temperature range set.
[**Out of**]: The alarm sounds when the temperature is out of the temperature range set.
[**Shear**]: The alarm sounds when the temperature exceeds the alarm setting within one minute.
4. Do the appropriate procedure below.
[Over] or [Under]
 - 1) Tap [**Temperature Alarm Value**] to display the software keyboard.
 - 2) Set the value, then tap [**✓**]. Go to step 5.[Within] or [Out of]
 - 1) Tap [**Temp. Alarm Range Min Value**] to display the software keyboard.
 - 2) Set the minimum value, then tap [**✓**].
 - 3) Tap [**Temp. Alarm Range Max Value**] to display the software keyboard.
 - 4) Set the minimum value, then tap [**✓**]. Go to step 5.

[Shear]

- 1) Tap [Temp. Shear Alarm Value] to display the software keyboard.
 - 2) Set the value, then tap [✓]. Go to step 5.
5. Tap [×] on the title bar to finish and close the menu.

Note: To disable this alarm, turn it off at step 3 in the above procedure.

2.12.3 Depth alarm

The depth alarm tells you when the depth to the bottom is shallower than the value you set. Requires depth data.

Note: Requires connection to appropriate sensor.

1. Open the [Alarms] menu.
2. Tap [Depth]→turn on [Depth Alarm].
3. Tap [Depth Alarm Value] to display the software keyboard.
4. Set the value, then tap [✓].
5. Tap [×] on the title bar to finish and close the menu.

Note: To disable this alarm, turn it off at step 2 in the above procedure.

2.12.4 Speed alarm

The speed alarm tells you when the speed of your ship is over or under the limit set. Set the value at [Speed Alarm Value].

Note: Requires connection to a speed sensor.

1. Open the [Alarms] menu.
2. Tap [Own Ship]→[Speed Alarm].
3. Tap [Over] or [Under], then tap [<] on the title bar to return to the previous menu.
[Over]: The alarm sounds when the speed is over the set value
[Under]: The alarm sounds when the speed is under the set value.
4. Tap [Speed Alarm Value] to display the software keyboard.
5. Set the value, then tap [✓].
6. Tap [×] on the title bar to finish and close the menu.

Note: To disable this alarm, turn it off at step 3 in the above procedure.

2.12.5 Wind speed alarm

The wind speed alarm tells you when the wind speed is over the limit set. Set the value at [Wind Speed Alarm Value].

Note: Requires connection to a speed sensor.

1. Open the [Alarms] menu.
2. Tap [Wind]→[Wind Speed Alarm].
3. Tap [Apparent] or [True] as required, then tap [<] on the title bar to go back one layer in the menu.
[Apparent]: Triggers the alarm when the apparent wind speed exceeds the set speed.

2. CHART PLOTTER

[True]: Triggers the alarm when the true wind speed exceeds the set speed.

4. Tap [Wind Speed Alarm Value] to display the software keyboard.
5. Set the value, then tap [✓].
6. Tap [×] on the title bar to finish and close the menu.

Note: To disable this alarm, turn it off at step 3 in the above procedure.

2.12.6 Anchor watch alarm

The anchor watch alarm tells you that your ship has moved a distance greater than the set value when the ship must not be moving.

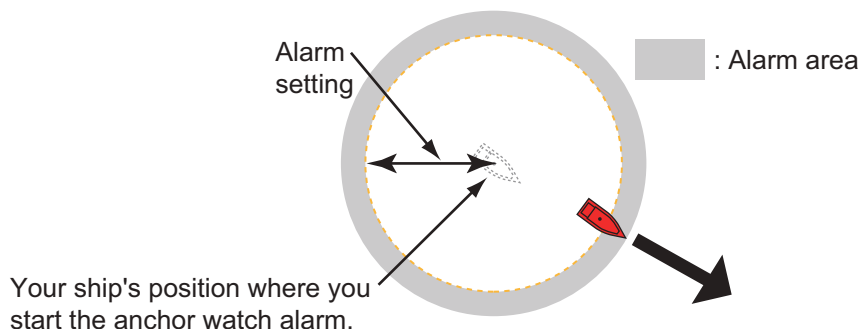

The anchor watch alarm setting is shared across all the units in the same network. A smartphone or tablet can also be used to set the alarm.

Note: Login to My TimeZero account to enable sharing of data among TZT9E/13E units. See section 1.21.

1. Open the [Alarms] menu.
2. Tap [Anchor Watch]→[Anchor Watch Alarm Value] to display the software keyboard.
3. Set the value (radius of the anchor watch zone), then tap [✓].
4. Turn on [Anchor Watch Alarm].
5. Tap [×] on the title bar to finish and close the menu.

A green circle, with an anchor symbol at its center, marks the anchor watch zone. If the boat nears the edge of the circle, the message "Anchor Watch Warning" (yellow Status bar) appears in the Status bar and the circle turns yellow. If the boat goes out of the circle, the message "Anchor Watch Alarm" (red Status bar) replaces "Anchor Watch Warning" and the circle turns red and flashes.

To reset the anchor watch alarm zone (when your boat goes out of the zone), tap the [Reset] icon on the Navigation bar. A message asks you if you are sure to reset the anchor watch alarm. Tap [Yes] to reset.

To move the zone or adjust the zone radius, tap the anchor symbol or the red circle to show the Pop-up menu. Tap [Edit Anchor Watch]. To move the zone, drag the position icon. To adjust the radius of the zone, drag the zone size icon. Tap [End Editing] at the top right corner to finish.

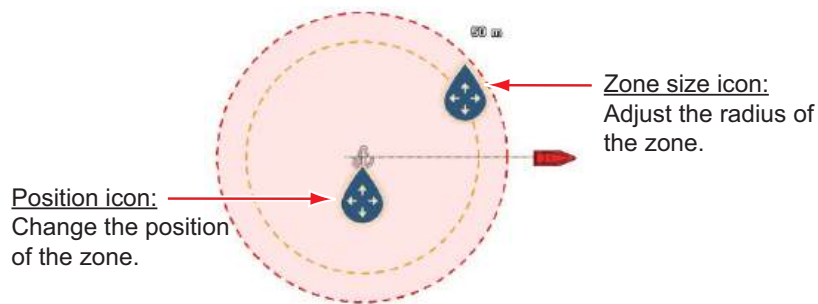

To deactivate the alarm, turn it off at step 4 in the procedure. The alarm can also be deactivated from the Navigation bar. Tap [STOP]. You are asked if you are sure to stop the anchor watch alarm. Tap [Yes] to deactivate the alarm.

The alarm can also be activated from the chart plotter display. Tap the vessel icon to show the Pop-up menu. Tap [Anchor Watch Alarm] to activate the alarm.

If the two finger tap function (short or long) is set for [Anchor Watch Alarm], the anchor watch alarm can be toggled on or off by tapping the screen with two fingers (see section 1.16). When the screen is tapped, the message "Anchor Watch Alarm enabled" (or disabled) appears for three seconds.

Anchor watch position averaging

The anchor watch position may vary depending on received GPS position. If the position changes often, you can average it to prevent random changes. The higher the setting value, the greater the degree of averaging. However, if the averaging is set too high, the calculation of position may slow.

1. Open the [Alarms] menu.
2. Tap [Anchor Watch]→[Anchor Watch Position Averaging].
3. Select a position averaging time.
4. Tap [×] on the title bar to finish and close the menu.

Note: To cancel position averaging, select [Off] at step 3.

2.12.7 Low fuel alarm

The low fuel alarm informs you when your fuel level drops below the setting percentage of fuel.

1. Open the [Alarms] menu.
2. Tap [Fuel]→turn on [Low Fuel Alarm].
3. Tap [Low Fuel Alarm Value] to display the software keyboard,
4. Set the value, then tap [✓].
5. Tap [×] on the title bar to finish and close the menu.

Note: To disable this alarm, turn it off at step 4 in the above procedure.

2.12.8 Other Alarms menu items

Below are the [Alarms] menu items not previously mentioned.

[Hardware Alarm]: Turn off to disable the hardware-related alarms.

[Notification Sound]: Activate or deactivate the notification sound (for "Waypoint Crossing" (see section 5.10), "End of Route" (section 4.16) or fish finder alarms (section 6.14)).

[Alarm Sound when NAVpilot is engaged]: Activate or deactivate the notification sound when the autopilot is engaged to or disengaged from this system.

[Alarm Sound]: Disable or enable the buzzer, which sounds when an alarm is breached.

[Sound Alarm Until Acknowledged]: Turn this item on to sound the aural alarm until an alarm is acknowledged (see "How to silence the audio alarm" on page 2-16).

[Save Log File]: Save alert list to the media connected to the USB port.

[Own Ship Alarm Zone]: Get an audiovisual alarm when your vessel approaches a boundary within the specified distance

[Own Ship Alarm Zone Warning]: Set the radius for the [Own Ship Alarm Zone].

[Notify when NAVpilot is engaged]: Be notified when NAVpilot becomes engaged.

[NMEA 2000 Alert]: When set to on, received NMEA 2000 alert is shown at the top of the screen on the Status bar.

[Reset Default Page Settings]: Reset the [Alarms] menu settings to default.

2.12.9 Alarms list

When an alarm is violated, you can see the name of the offending alarm on the [Alarms] list. The list stores both warning and system messages.

To display the Alarms list, Home page→[Lists]→[Alarms]. Active alarms are flashing and have a red vertical bar at the left margin. Tap an active alarm to acknowledge it and stop the flashing. After the cause of an alarm is removed, the alarm message is moved to the [HISTORIC] section. Tap [x] on the title bar to finish and close the list.

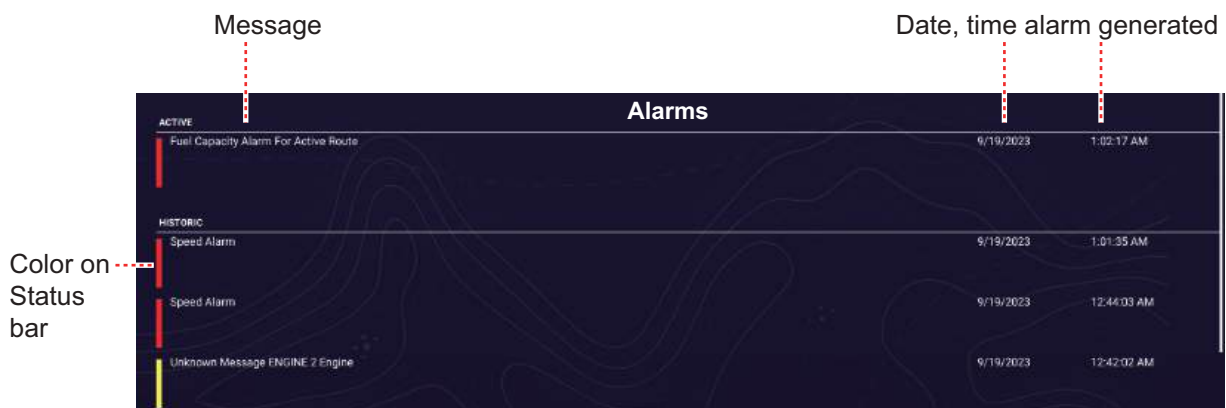

2.13 Track

The track (or movement) of your ship is plotted on the screen with position data fed from a GPS navigator. Your track lets you see how your ship has moved over time.

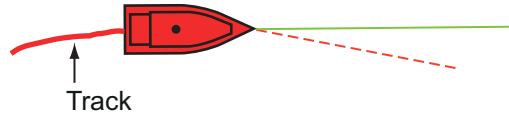

The track is saved to the internal memory if track recording is activated. A line runs between each track point. The internal memory stores a maximum of 100,000 track points.

Track is not erased when the power is turned off. Unnecessary track can be deleted. Track can also be used to create a route.

2

2.13.1 How to start, stop recording the track

Start recording

Method 1: Open the Slide-out menu, then tap [Track Recording].

Method 2: Tap the vessel icon to display the Pop-up menu, shown right. Turn on [Track Rec.] to start recording.

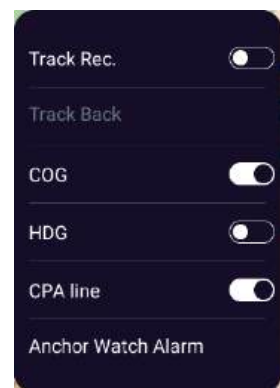

Stop recording

Method 1: Open the Slide-out menu, then tap [Track Recording].

Method 2: Tap the vessel icon to display the Pop-up menu. Turn off [Track Rec.] to stop recording.

Method 3: Tap the track to show the Pop-up menu, shown below. Tap [Stop Track] to stop recording.

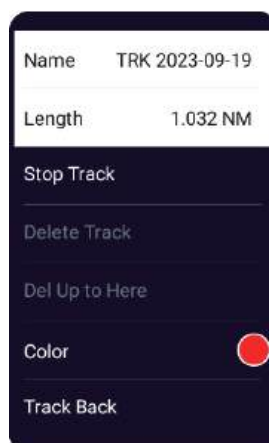

2.13.2 How to show or hide the track display

Open the Layers menu, tap the [User Objects] tab, then turn [Tracks Show/Hide] on or off.

2.13.3 Track recording interval

Tracks are recorded at specified time or distance intervals to the internal memory of this unit.

A shorter interval gives a smoother, clearly reconstructed track, however the overall distance/time that can be recorded is shorter.

When the positioning data source is one of the devices listed below, the following occurs:

- GP-330B serial no. 4457-8875 or after
 - SC-30
 - SC-33
 - SCX-20
 - GP340
- Tracks are plotted at very short intervals for five minutes immediately behind your vessel, regardless of the recording interval selected, to give you a more accurate and smooth track.

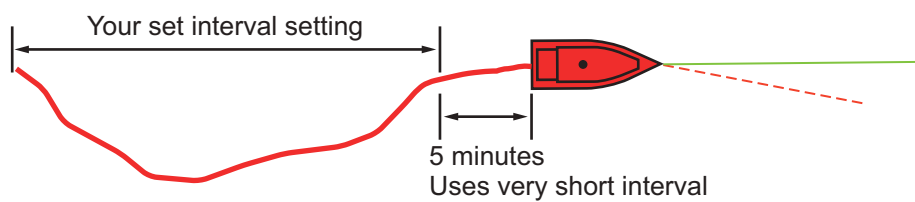

- Track plotting reverts to the selected interval after the five minutes pass, or if recording is stopped within the first five minutes.

For time-based intervals

1. Home page→[Settings]→[Ship & Track]→[Track]→[Track Interval].
2. Tap [Time], then tap [<] on the title bar to go back one layer in the menu.
3. Tap [Time Interval].

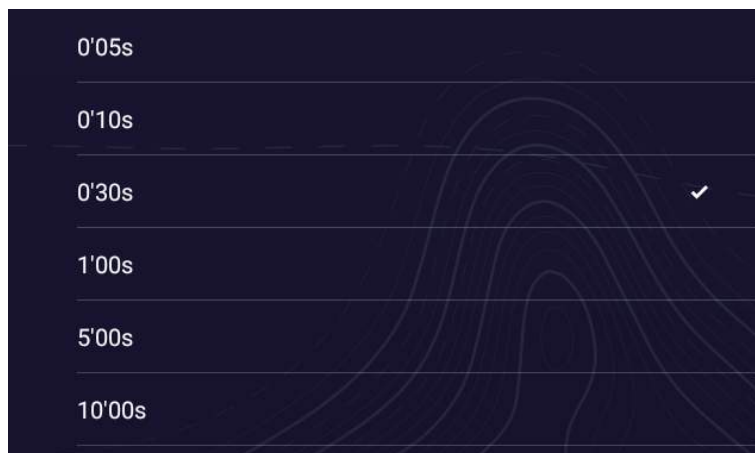

4. Tap a time interval.
5. Tap [x] on the title bar to finish and close the menu.

For distance-based intervals

1. Home page→[Settings]→[Ship & Track]→[Track]→[Track Interval].
2. Tap [Distance], then tap [<] on the title bar to go back one layer in the menu.
3. Tap [Distance Interval] to show the software keyboard.
4. Input the desired interval, then tap [✓].
5. Tap [×] on the title bar to finish and close the menu.

2.13.4 Track color

Track can be displayed in a single color or multiple colors. For multiple colors, you can display the track according to one of the conditions shown below.

- Bottom Discrimination
- Day of the Week
- Depth
- Depth Variation
- Speed
- SST Range
- SST Variation
- Trip

Note: For the TZT9E/13E, to change the color according to the findings of bottom discrimination, use the built-in fish finder of TZMAP9/13, NavNet TZtouch2 (TZT2BB only), NavNet TZtouch3 or NavNet TZtouchXL (TZT10X/13X/16X), or network sounder TZT9E/13E, BBDS1, DFF1-UHD, DFF1UHD+.

Open the Home page

1. Home page→[Settings]→[Ship & Track]→[Track]→[Track Color].
2. Tap [Fixed] or [Variable], then tap [<] to go back one layer in the menu. For [Fixed], go to the next step. For [Variable], go to step 5.
Note: [Fixed] or [Variable] can also be selected from the Layers menu, in the [User Objects] tab.
3. Tap [Fixed Color Setup].

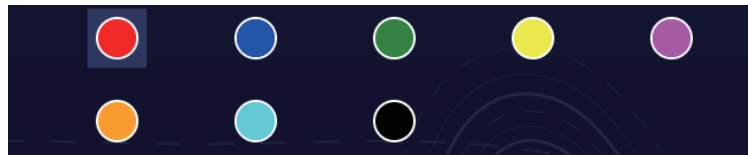

4. Select a color, then go to step 10.

2. CHART PLOTTER

- Tap [Variable Color], then tap an option.

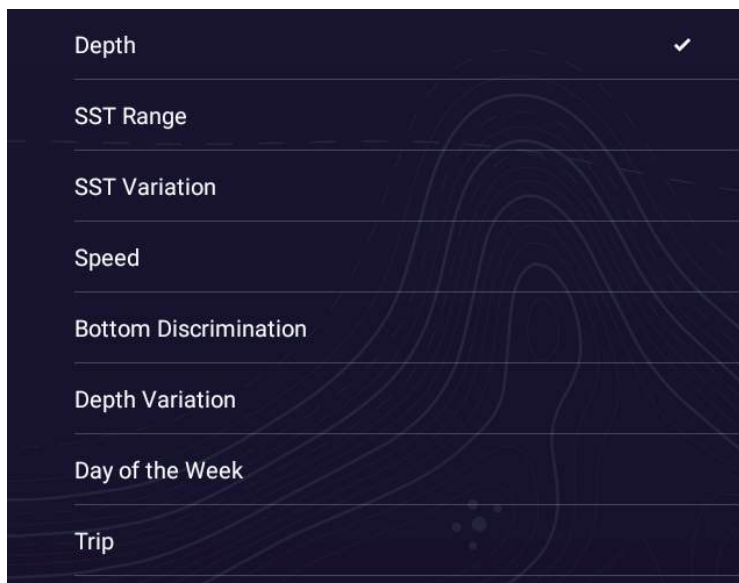

- Select one of the following, then tap [<] on the title bar to go to the previous menu.
 - [Depth]:** Change the color of the track according to depth.
 - [SST Range]:** Change the color of the track according to sea surface temperature.
 - [SST Variation]:** Change the color of the track according to variation in sea surface temperature. The following is an example.

Temp. range (°C)	Color	Temp. range (°C)	Color
16.60 to 16.80	Red	17.61 to 17.80	Orange
16.81 to 17.00	Yellow	17.81 to 18.00	Blue
17.01 to 17.20	Green	18.01 to 18.20	Red
17.21 to 17.40	Light-blue	18.21 to 18.40	Yellow
17.41 to 17.60	Purple	18.41 to 18.60	Green

Then, the screen will display up to blue by the same method, and then return to red. Also, if there is no water temperature data, the color is the color set for color 1 (in the example above, red).

[Speed]: Change the color of the track with speed.

[Bottom Discrimination]: Change the color of the track with bottom sediment.

[Depth Variation]: Change the color of the track with depth variation. The depth at the start of track recording becomes the reference depth.

[Day of the Week]: The track color changes on the specified day of the week.

[Trip]: The color of the track changes in the order of red, blue, green, yellow, purple, orange, cyan. Go to step 10.

Note: In a single voyage (from power on to power off) the track is displayed in a single color. However, if the track recording is started within 4 hours from the end of the previous track recording, the track color will not be changed.

7. Tap [Variable Color Setup].

Color icon Threshold amount



For [Depth]



For [SST Range]



For [SST Variation]



For [Depth Variation]



For [Bottom Discrimination]



For [Day of the Week]



For [Speed]

2

8. **[Bottom Discrimination]:** Tap [Mud], [Sand], [Rock], or [Gravel].
[Day of the Week]: The track color changes on the specified day (Monday to Sunday).
Others: For others, tap a color (seven choices).
9. Do one of the following depending on your selection at step 6.
[Depth]: Set the color for each depth range. For example, when the red icon is selected in [Color 1], the track is red for depths from 5 to 10 ft.
[SST Range]: Set the color for each range of sea surface temperature. For example, when the blue icon is selected in [Color 1] (temperature range: 10 to 15°F), the track is blue for temperatures from 10 to 15°F.
[SST Variation]: Set the color for each temperature variation. Tap [Step 0.2°F], then set each color. Do the same for [Step 2.0°F].
[Speed]: Set the color for each speed range. For example, when the blue icon is selected in [Color 1], the track is blue for speed from 0 to 5 kn.

2. CHART PLOTTER

[Bottom Discrimination]: Set the color for each bottom sediment. For example, when the blue icon is selected in [Mud], the track where mud is found is blue.

[Depth Variation]: Set the color for each depth variation. Tap [Step 2.0 ft], then set each color. Do the same for [Step 20.0 ft], and [Step 200.0 ft].

[Day of the Week]: Specify the color to paint the track for each day of the week.

Note: For [Depth] and [Speed], the track is shown in black when the set maximum value is exceeded.

10. Tap [×] on the title bar to finish and close the menu.

On the chart plotter display

1. Tap a section of track to display the Pop-up menu.
2. Tap [Color].
3. Tap a color.

2.13.5 Track thickness

You can set the thickness of the track. If you are following the same track many times, it can be useful to show the track in the thinnest width, to prevent overlapping of track on the screen.

1. Home page→[Settings]→[Ship & Track]→[Track].
2. Use the slider bar for [Track Thickness] to set desired thickness. (The thickness can also be set with the software keyboard. Tap the keyboard in the [Track Thickness] field then enter desired thickness.)
Setting [1] is the thinnest; [4] is the thickest.
3. Tap [×] on the title bar to finish and close the menu.

2.13.6 How to create a route with past track (follow track)

You can use past track to create a route. The route is saved to the [Routes] list.

1. Tap the past track to use to create a route to show the Pop-up menu.

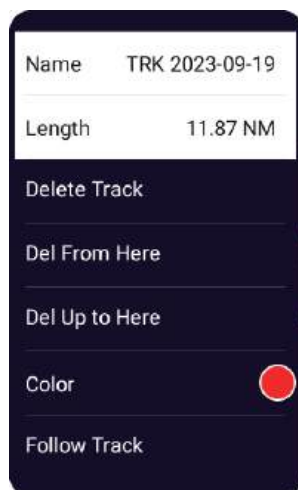

2. Tap [Follow Track].
3. Enter route name, then tap [✓] to save the route name and finish.
A route is created with past track. Points are automatically entered and arrows (see "1" in the illustration at the bottom of the next page) point in the direction of travel.

2.13.7 How to create a route with track currently being recorded (track back)

You can create a route with track that is currently being recorded. This method can be useful for retracing track; for example, when you need to retrieve crab pots or the like. The route is saved to the [Routes] list.

1. Tap the current track or vessel icon to show the Pop-up menu.

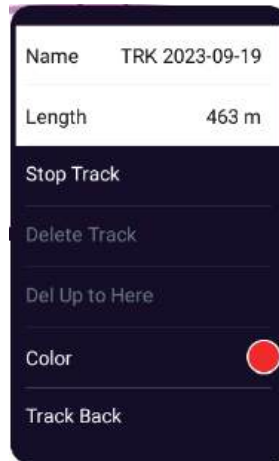

Pop-up menu when track is selected

2. Tap [Track Back].
3. Enter route name, then tap [✓].

A route is then created as shown below.

- Points are created along the route. Arrows on the route point in the direction of travel.
- A light purple dashed line runs between the starting point ("1" in the figure below) and go to point ("2" in the figure below). A solid yellow line shows the shortest distance between current position and go to point.
- Route points are highlighted in yellow.
- Arrival range and cross track error lines are shown.

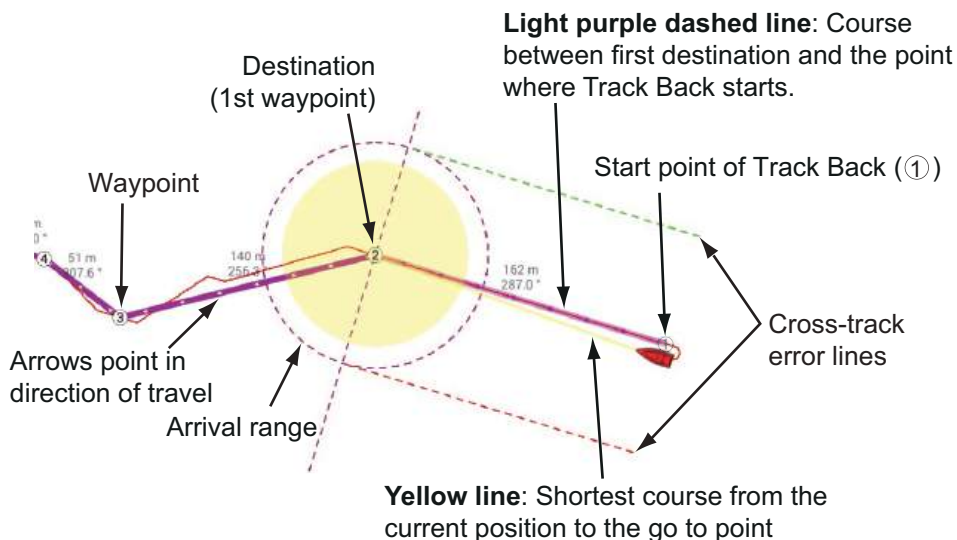

2. CHART PLOTTER

When you are following a track back route, the functions described below are available, from the Pop-up menu. Tap the yellow line to display the Pop-up menu. For details about each function, see chapter 5.

- **[Stop Nav.]**: Stop following the route.
- **[Restart Nav.]**: Restart following the route.
- **[Extend]**: Extend a route from the last point on the route.
- **[Rte Detail]**: Open the [Route Detail] list.

2.13.8 Tracks list

Saved tracks are stored in the [Tracks] list, where you can view, edit and delete tracks. Track is initially saved under the year, month and day of creation. You can change the name of a track as desired.

The name, color, date/hour of creation, length, and duration of each track are shown in the list.

Track can be sorted by creation date, name, color, duration, length, and range. The current search method is highlighted in gray.

How to show the Tracks list

1. Home page→[Lists]→[Tracks]. The active track is denoted by replacing [Name] with [Active Track] (in flashing red characters).

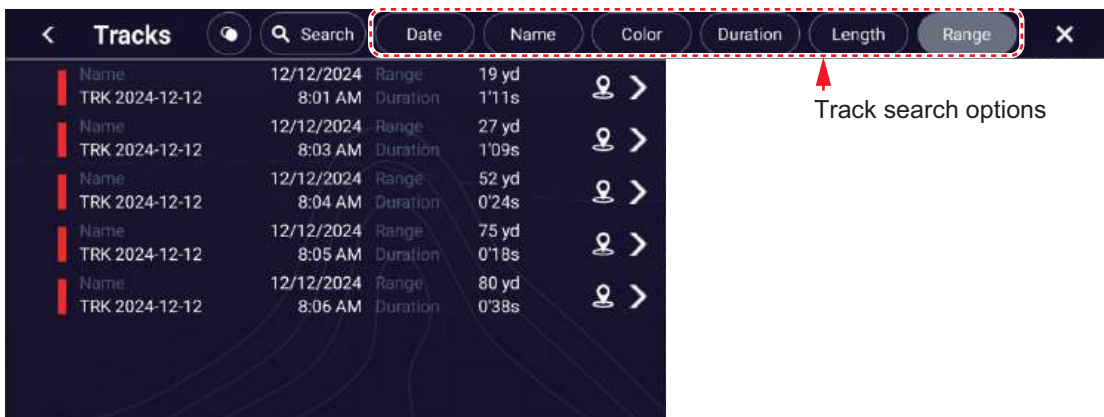

2. To search, sort the list, follow the applicable procedure on the next several pages.

How to sort track

[Date] Sort by date registered, in oldest-to-newest/newest-to-oldest order (tap the button to change the order).

[Name]: Sort by track name, in alphabet order (tap the button to change the order).

[Color]: Sort by color (tap the button to change the order).

[Duration]: Sort by duration (tap the button to change the order).

[Length]: Sort by track length, from shortest to longest/longest to shortest (tap the button to change the order).

[Range]: Sort by range from own ship, from nearest to farthest/farthest to nearest (tap the button to change the order).

How to search track

Tracks can be searched by character string, name, and color.

Search by character string

- a) Tap the magnifying glass icon at the top of the screen to show the software keyboard.

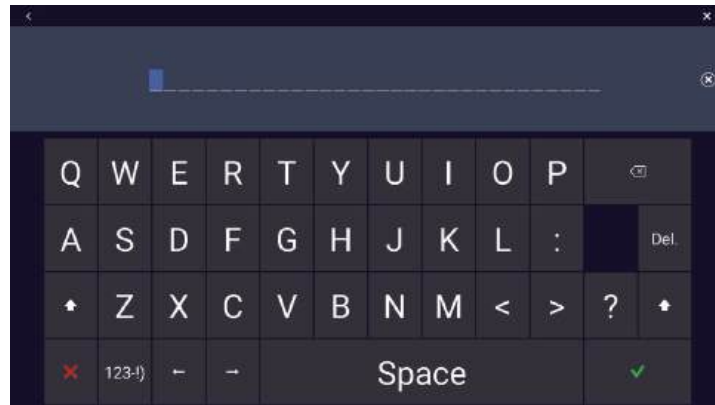

- b) Enter search string (track's full name, or 2-3 characters), then tap [✓].
The track searched appears in the [Tracks] list.

Search by alphabet

- a) Confirm that the sort method is selected to [Name].
b) Tap applicable alphabet heading in the list.

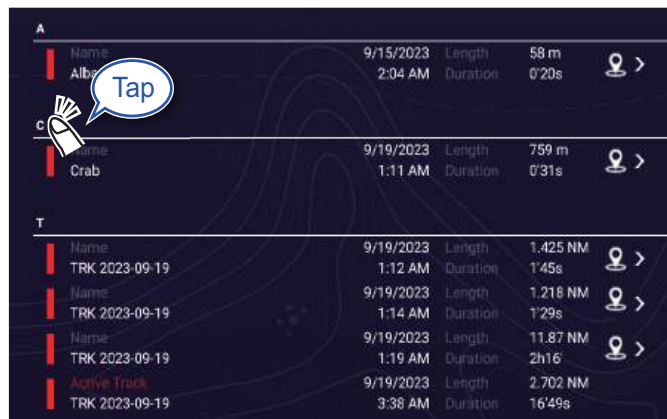

The search keyboard appears, with the searchable alphabets shown in blue.



- c) Tap the alphabet to search.

2. CHART PLOTTER

Search by color

- Confirm that the sort method is selected to [Color].
- Tap any track color icon.

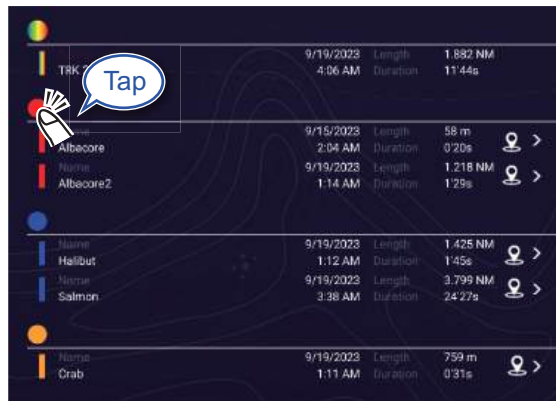

The color search panel appears. (The panel shows only the colors used.)



- Tap the color to search. The tracks corresponding to the color tapped appear in the [Tracks] list.
- To confirm or edit track information, tap corresponding track.



- To change the name or color of a track, tap the name or color of a track.
- Tap [x] on the title bar to finish and close the list.

How to edit tracks collectively via the Track list

The  icon in the title bar on the [Tracks] list allows you to edit routes collectively.

- Home page → [Lists] → [Tracks].
- At the top of the [Track] list, choose how to sort the tracks.

3. Tap the  icon. In the example list below the tracks are sorted by color.

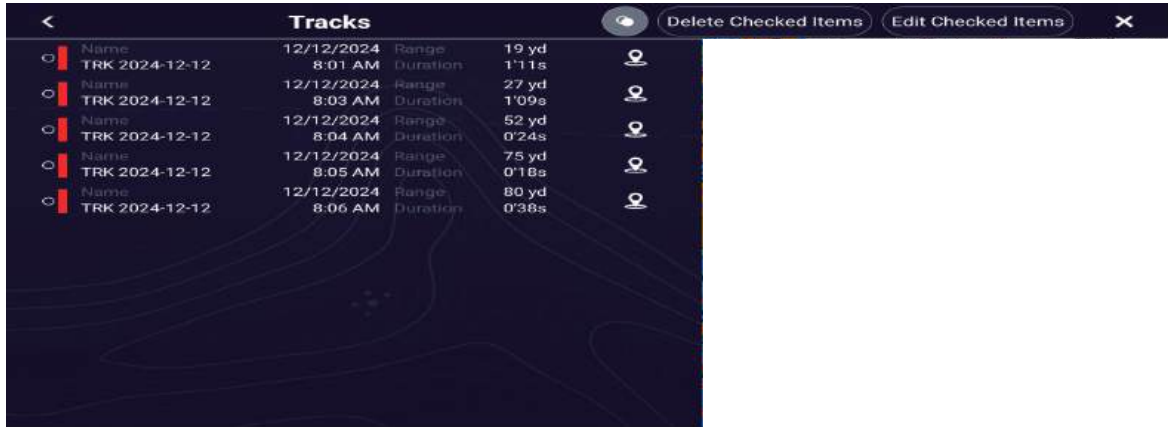

2

4. Put a checkmark (✓) in the checkbox of the track to edit, or check a sort method to edit all tracks according to that method.
5. On the title bar, tap [Edit Checked Items]. The display looks something like the figure below.

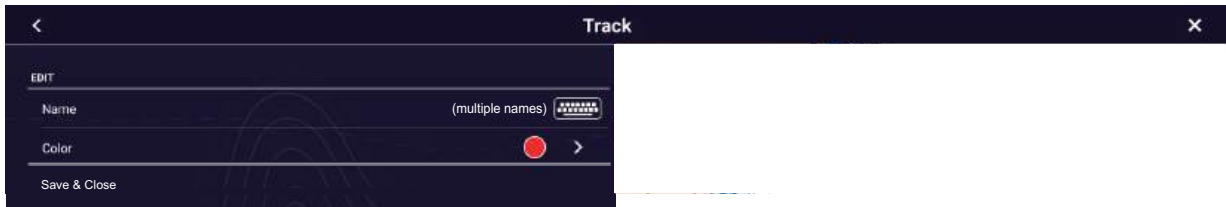

6. Tap item to change.
7. Tap [Save & Close] to finish and close the window.

How to put track at the screen center

Home page→[Lists]→[Tracks]. Tap the track to display, then tap [Find on Chart]. The equipment switches to the chart plotter mode, and the selected track appears at the center of the chart plotter display.

2.13.9 How to find the number of track points used

Home page→[Settings]→[General]→[Data Usage]. In the example below, 228 track points out of 100,000 have been used.



Note: The number of track points used can also be found in the Home Page→[Settings]→[Ship & Track]→[Track]→[Tracks Memory].

2.13.10 How to delete tracks

If the screen becomes full of track, you can not know which is the newer track. In this case, delete the tracks you do not need.

Note: If the power is restarted within two minutes after deleting or editing track, the deleted or edited contents may not be reflected due to the cycle of backup processing.

How to delete tracks individually

Past tracks can be deleted individually. Current track cannot be deleted.

- **Deleting an on-screen track**

Tap the track to delete, then select [Delete Track] from the Pop-up menu.

- **Deleting from the Tracks list**

1. Home page→[Lists]→[Tracks].
2. If necessary, change the track sort method from the title bar.
3. Tap the track to delete to show the edit screen.
4. Tap [Delete].
5. Tap [×] on the title bar to finish and close the list.

How to delete a specific part of a track

You can delete a track partially. Tap the part of a track to delete to show the Pop-up menu. Tap [Del From Here] or [Delete Up to Here] as applicable.

- **[Del From Here]:** Delete from the selected point on the track to the end of the track. This menu does not appear for tracks that are currently being recorded.
- **[Delete Up to Here]:** Delete from the start of the track to a point on the selected track.

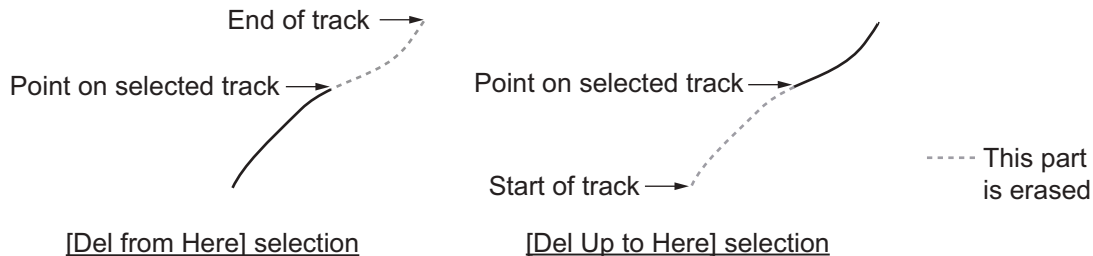

How to delete tracks collectively via the Track list

The  icon in the title bar on the [Track] list allows you to delete routes collectively.

1. Home page→[Lists]→[Track].
2. At the top of the [Track] list, choose how to sort the tracks.
3. Tap the  icon. In the example list below the tracks are sorted by color.

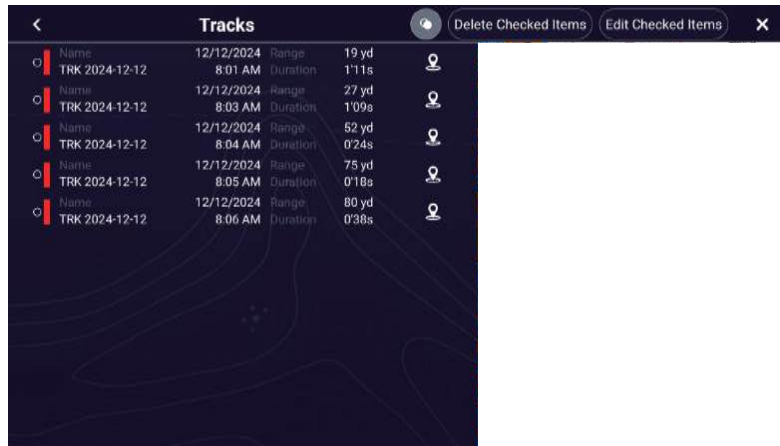

4. Tap the hollow circle to the left of the track(s) to delete to fill the circle in white, or check a sort method to delete all tracks by that method.
5. Tap [Delete Checked Items]. A message asks if you are sure to delete checked items.
6. Tap [OK] to delete the items
7. Tap [x] on the title bar to finish and close the menu.

How to delete all tracks

1. Home page→[Settings]→[Ship & Track]→[Track].
2. Tap [Delete All Tracks]. The message "THIS ACTION WILL PERMANENTLY DELETE ALL TRACK." appears.
3. Tap [OK].
4. Tap [x] on the title bar to finish and close the menu.

How to automatically delete tracks

The internal memory stores a maximum of 100,000 track points. When the memory for track points becomes full, the equipment can automatically delete the oldest track points to get space for new track points. To get automatic deletion of track, do as follows:

1. Home page→[Settings]→[Ship & Track]→[Track].
2. Turn on [Automatic Track Deleting].
3. Tap [x] on the title bar to finish and close the menu.

2.14 Chart Plotter Menu

This section describes the [Chart Plotter] menu items not previously mentioned.

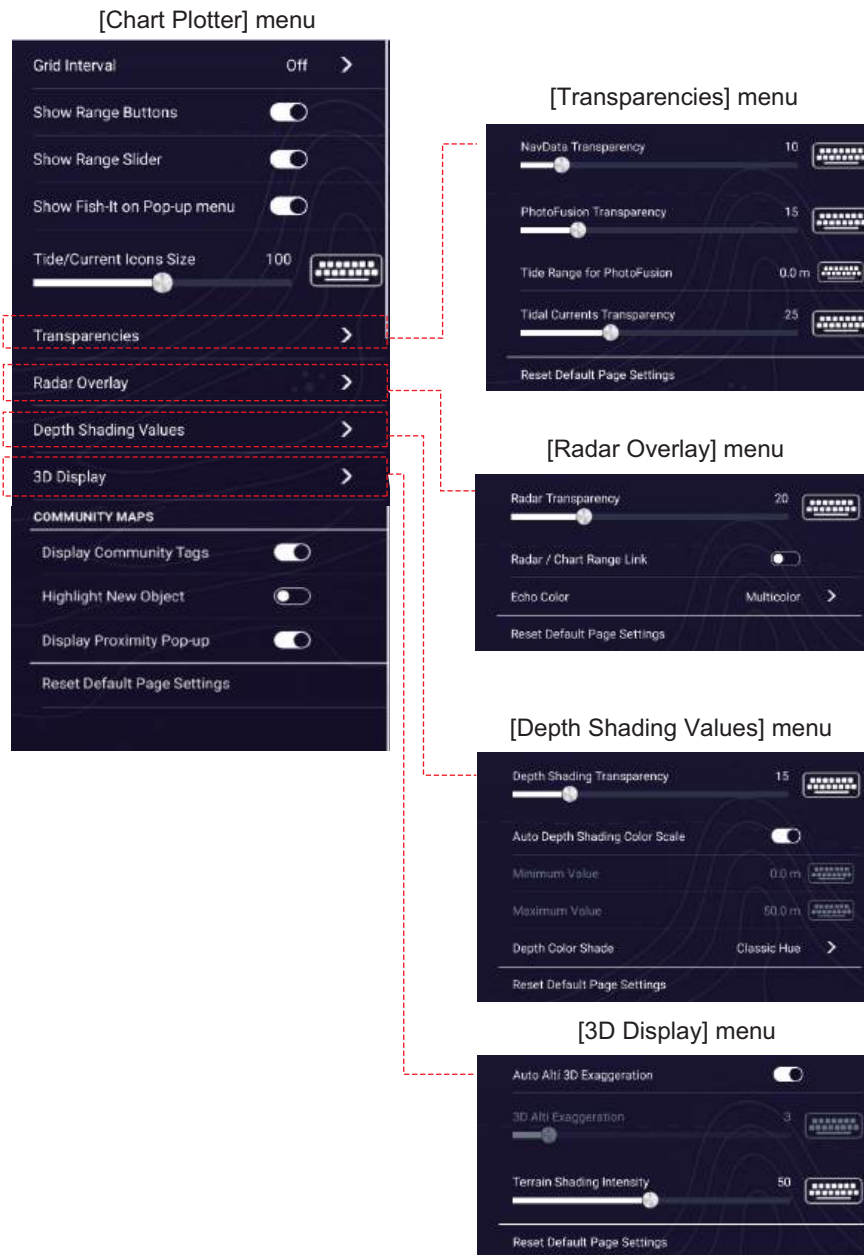

[Grid Interval]: Set the distance between grid lines. The options are [Off] (no lines), [Very Small], [Small], [Medium], [Large], and [Very Large].

[Show Range Buttons]: Show or hide the range buttons (+, -).

[Show Range Slider]: Show or hide the range slider shown on the right-hand side of the screen.

[Show Fish-it on Pop-up menu]: Select whether to show or hide the [Fish-It] function in the Pop-up menu, which appears when you tap a point or event mark on the chart plotter display. [Fish-It] appears in the Pop-up menu even if the catch and ACCU-FISH icons are hidden.

[Tide/Current Icons Size]: Set the size of the icon for tide and current.

[Transparencies]

[Nav Data Transparency]: Set the degree of transparency for the navdata display.

[PhotoFusion Transparency]: Set the degree of transparency for the sea surface area of the satellite photo overlay. See subsection 3.2.2.

[Additional Layer Transparency]: Set the degree of transparency for the sea surface portion of the CMOR chart (optional supply). Not shown otherwise. See section 16.6.

[Tide Range for PhotoFusion]: Set the degree of transparency for the tide range in the satellite photo overlay.

[Tidal Currents Transparency]: Set the degree of transparency for the tidal currents display.

[Reset Default Page Settings]: Reset the [Transparencies] menu settings to default.

[Radar Overlay]

[Radar Transparency]: Set the degree of transparency for the radar echo.

[Radar / Chart Range Link]: Activate or deactivate matching the overlay with radar ranges.

[Echo Color]: Tap the color for the radar echo.

[Reset Default Page Settings]: Reset the [Radar Overlay] menu settings to default.

[Depth Shading Values]

[Depth Shading Transparency]: Set the degree of transparency for the depth shading overlay.

For the other menu items, see subsection 3.2.1.

[Reset Default Page Settings]: Reset the [Depth Shading Values] menu settings to default.

[3D Display]

[Auto Alti 3D Exaggeration], **[3D Alti Exaggeration]**: See subsection 3.1.2.

[Terrain Shading Intensity]: Set the intensity of the shading for the seabed topography.

[Reset Default Page Settings]: Reset the [3D Display] menu settings to default.

[Community Map]

See section 2.16.

[Reset Default Page Settings]: Reset the [Chart Plotter] menu settings to default.

2.15 NAVpilot Series Auto Pilot

This section shows you to how to enable use of the NAVpilot with your system. For how to use the NAVpilot to steer to a point, see subsection 4.16.4.

The FURUNO NAVpilot Series Auto Pilot installs in the TZMAP9/13 or TZT9E/13E network to get automatic steering when going to a point or a route. The following NAVpilot functions can be controlled from a TZMAP9/13 or TZT9E/13E display:

- Control operation of the NAVpilot from this equipment (see subsection 2.15.2).
- Select the NAVpilot steering mode (AUTO or NAV), referring to the NAVpilot's Operator's Manual.
- Set up the NAVpilot (see subsection 2.15.4).

Note 1: To enter points or routes from your NAVpilot series, see section 4.16.4 and section 5.11.11.

Note 2: For information on how to navigate to a point (or route) using the NAVpilot Series, see subsection 4.16.4, subsection 5.11.11.

Note 3: If the NAVpilot-300 [On Arrival] setting is [Point Lock] when arriving at the final destination, the message "When you arrive at the final destination, the ship's speed will automatically decelerate and shift to the Point Lock. If you don't want to automatically shift to the Point Lock, set the operation menu for arrival to other than Point Lock." appears. Adjust the [On Arrival] setting if necessary.

2.15.1 How to enable use of the NAVpilot

To engage the NAVpilot with this equipment, open the [Settings]→[Routes] menu, then turn on [Navigate with AutoPilot]. Where the NAVpilot-700 series is used and a destination is set, you are asked if you want to navigate using the NAVpilot-700. For the NAVpilot-300/1000, you are asked to select a navigation mode.

If [Alarm Sound when NAVpilot is Engaged] is turned on in the [Alarms] menu, a beep sounds to tell you that the NAVpilot is engaged or disengaged. Note that the beep sounds regardless of the [Alarm Sound] setting.

Note: PGN sentences 129283 (Cross Track Error), 129284 (Navigation Data) and 129285 (Navigation - Route/WP Information) are turned on (in the [Initial Setup] menu) in the default setting, to enable use of the autopilot with this system.

2.15.2 How to show the NAVpilot control box in the Data window

1. Tap [DATA] or [ROUTE] on the Data window to select where to show the NAVpilot control box.
2. Tap [Edit] at the bottom of the Data window to show the [Edit NavData] display.
3. Tap [Add NavData] to show the available data boxes.
4. Tap [NAVpilot] to show the NAVpilot control box, in the area selected.

Note: The example figure below shows the Navpilot data box for the NAVpilot-300 series. The Turn/Menu button (↶/⚙️) is not shown on the NAVpilot-700 series, however all other indications are the same.

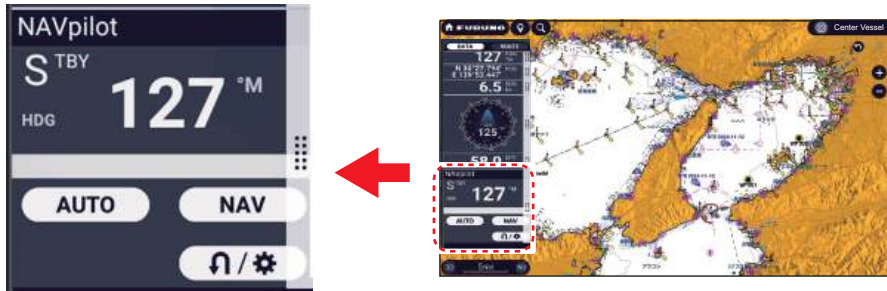

2.15.3 How to change the steering mode

You cannot switch to the wind mode (NAVpilot-700 series only) or dodge mode.

Manual (stand-by) mode

The figure below shows an example of the manual (stand-by) mode.

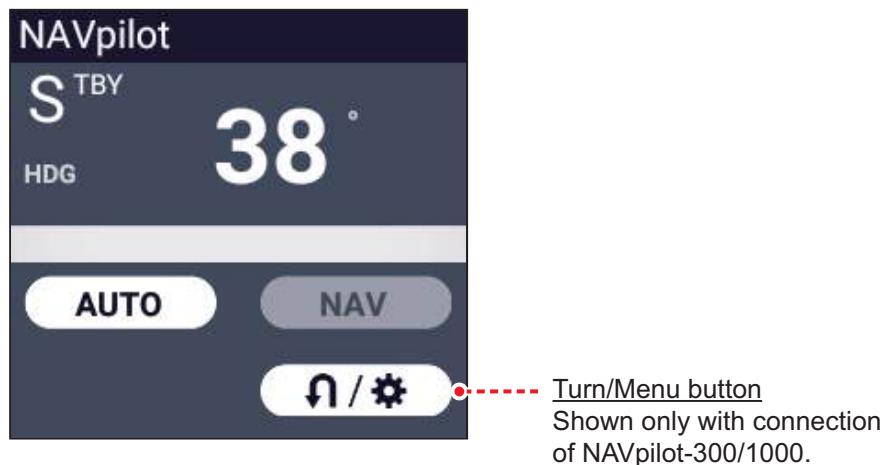

2. CHART PLOTTER

NAV mode

Tap the manual mode screen to switch to the NAV mode. The figure below shows an example NAV mode data box.

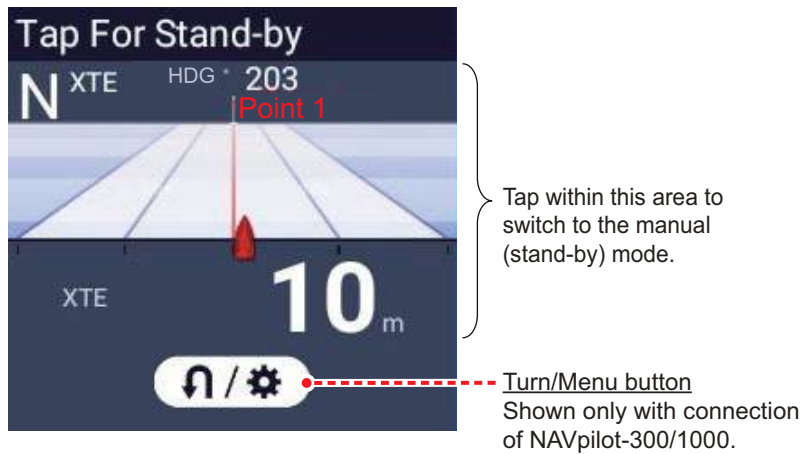

AUTO mode

Tap [AUTO] on the manual mode to switch to the NAV mode. The figure below shows an example AUTO mode data box.

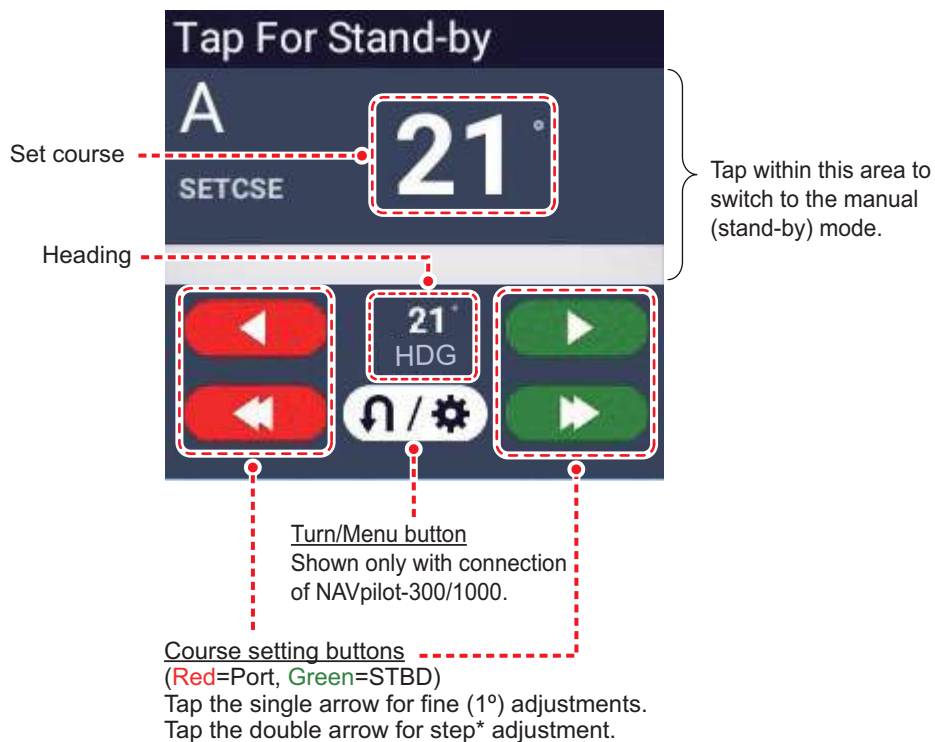

* The steering step interval (2 - 30°) can be set with [FURUNO] icon→[Settings]→[Routes]→[NAVpilot Steering Step]. Use the slider bar or software keyboard.

Do one of the following to set course:

- Use the course setting buttons to set course.
Tap or for change in 1° increments.
Use the steering step interval buttons (,) to set course in step intervals.

- Tap the set course line to display the context-sensitive window shown in the right-hand figure. Tap [Adjust]. Drag the set course line to set course. Tap [Finish] to complete the adjustment.

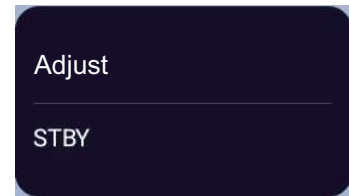

SABIKI mode (NAVpilot-300)

1. Tap the Turn/Menu button () in the NAVpilot data box to show the NAVpilot menu.
2. Tap [SABIKI Mode].



3. Use the set course buttons (see page 2-40) to change your course.

Turn mode (NAVpilot-300/1000). Fishing mode (NAVpilot-300)

1. Tap the Turn/Menu button () in the NAVpilot data box to show the NAVpilot menu.
2. Tap desired turn type. See the Operator's Manual for the NAVpilot-300/1000 for details.

2.15.4 How to change the NAVpilot settings

1. Tap the Turn/Menu button () in the NAVpilot data box to show the NAVpilot menu.
2. Tap [NAVpilot Settings] to show the NAVpilot Menu Manager window. (Alternatively, the screen shown below can be displayed by Home page→[Settings]→[Initial Setup]→[Network Sensor Setup]→[NAVpilot-300(Processor)].)

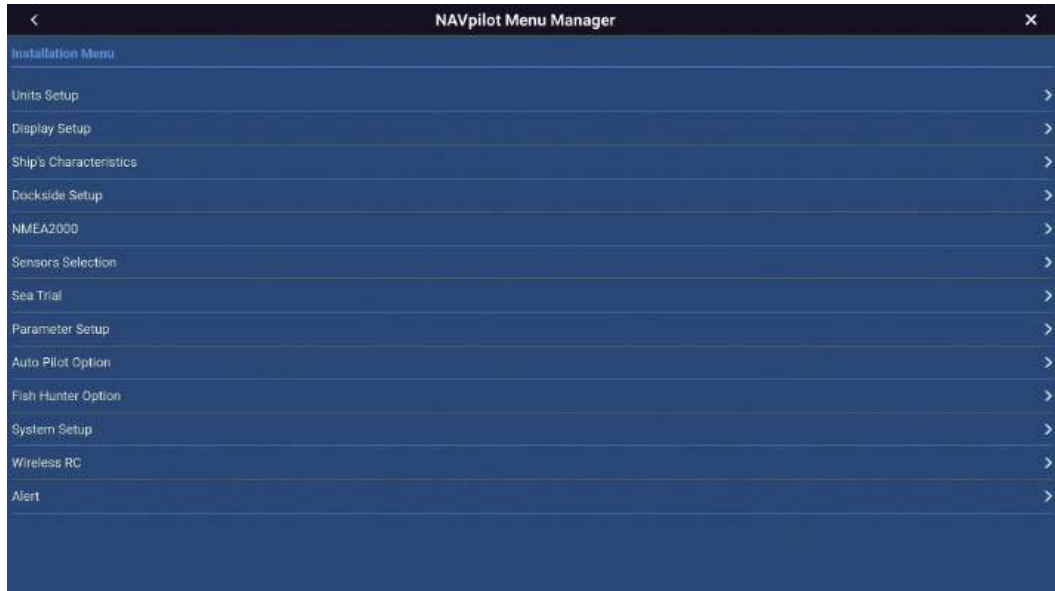

3. Change the settings as required, referring to the NAVpilot operator's manual.

2.16 Community Maps

The Community Maps feature allows boaters to create and edit chart targets. You can register information such as hazard obstacles, destinations, fishing points, etc. and points useful for navigation. The chart targets you create are shared online with other users of TZ MAPS charts.

To use this feature, configure the following settings in advance.

- Open the Layers menu, tap the [Charts] tab, set the chart type to [TZ MAPS], then select [TZ Vector] or [TZ BathyVision].
- Connect to the internet, referring to section 1.20.
- Login to your My TIMEZERO™ account, referring to section 1.21.
- Purchase the TZ MAPS chart license and save the TZ MAPS chart information on a microSD card, referring to section 16.6.1.

Note: Creation and editing of chart objects are shared online after being reviewed.

2.16.1 How to activate, deactivate Community Maps

On the chart plotter or weather display, open the Layers menu, tap the [Overlays] tab, then turn [Community Maps] on or off as appropriate. Community Maps chart objects appear when activated.

2.16.2 How to create a chart object

1. Tap the location where to insert a chart object.

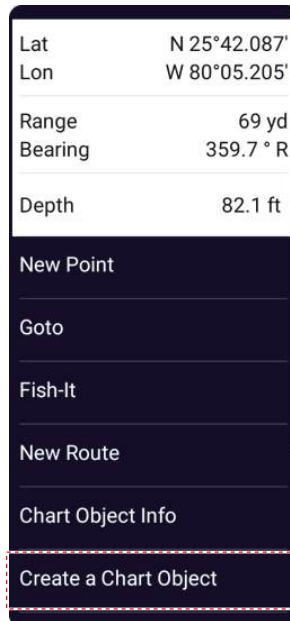

2

2. Tap [Create a Chart Object]. A circle appears at the location select at step 1 and the [Create a Chart Object] window appears.



2. CHART PLOTTER

3. Tap one of [Obstructions & Navigation], [Beacons], [Buoys], [Marina], or [Leisure Activity].

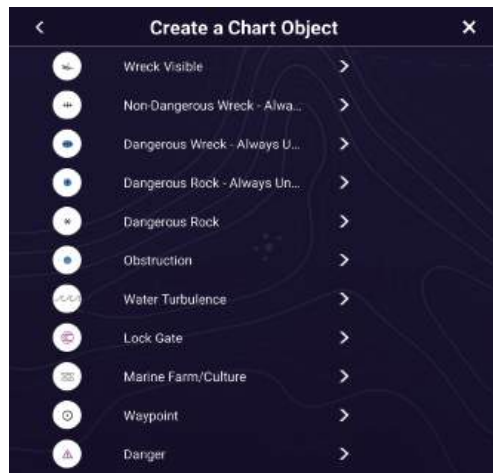

[Obstructions & Navigation] options

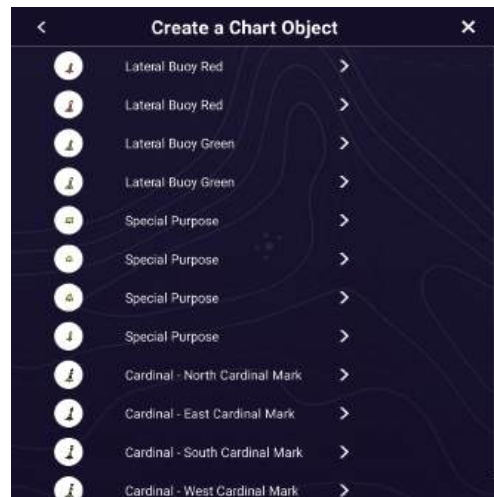

[Buoy] options

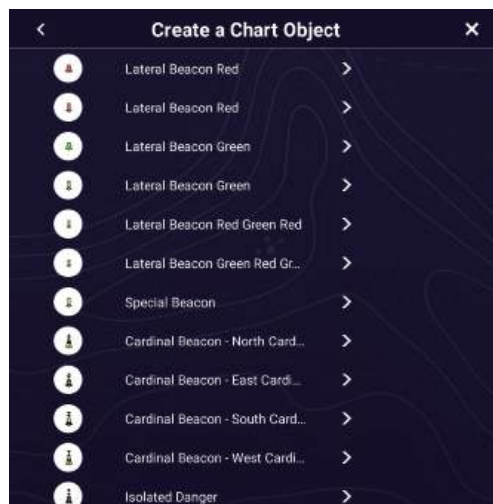

[Beacon] options

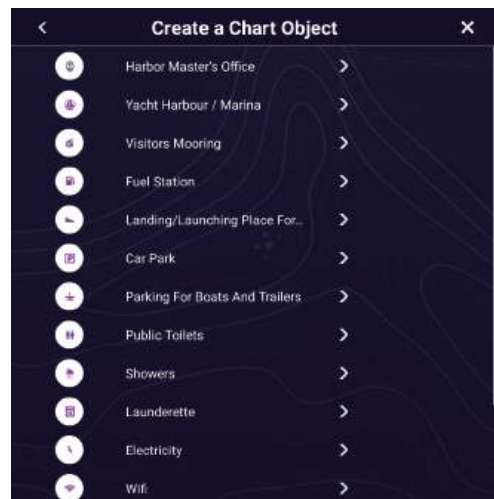

[Marina] options

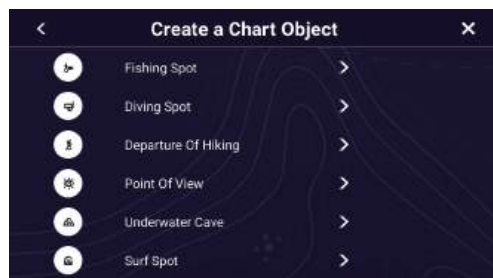

[Leisure Activity] items

4. Depending on the selection made at step 3, a window asks you to provide detailed information about the object. In the example figure below, the window for [Fishing Spot] of [Leisure Activity] is shown.

A screenshot of the 'Create a Fishing Spot' form. It has a dark background with light text and icons. The form contains four input fields: 'Name' with a text input field and a keyboard icon; 'Comment' with a text input field and a keyboard icon; 'Rating' with a five-star rating system and a chevron icon; and a 'Create' button at the bottom.

[Rating] only appears for [Marina] and [Leisure Activity].

- Enter name (max. 25 characters) and comment (max. 200 characters), then tap [✓].
Note: Do not enter personal information.
- If you selected [Marina] or [Leisure Activity], tap [Rating] and enter rating (1 - 5) for the object. Tap [<] on the title bar to go back one layer in the menu.

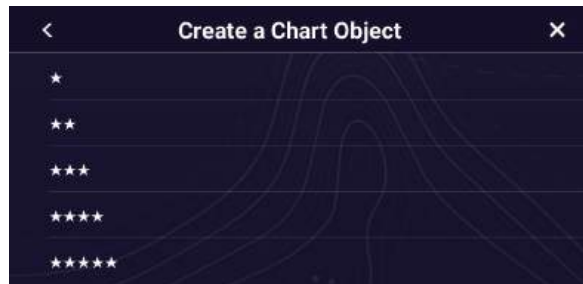

- Tap [Create]. The system creates the chart object. In the figure below, the object for a fishing spot is shown.

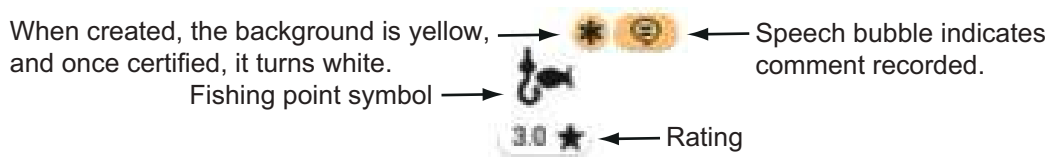

2.16.3 How to create a mooring

You can create a mooring on a desired location as follows.

- Tap the desired location on the chart plotter to create the mooring.

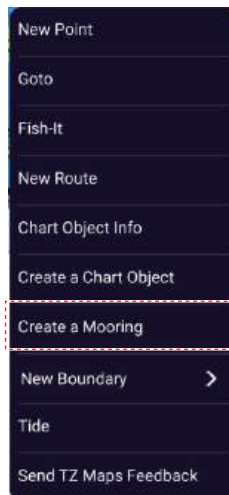

- Tap [Create a Mooring] on the pop-up menu to show the following window.

2. CHART PLOTTER

Note: If the [Mooring forecast] at the bottom left-hand corner of the screen is not displayed, a message "You must display the dynamic mooring layer to do this action. Do you want to display the layer?". Tap [OK] to display the mooring forecast. You can also set the mooring forecast on/off on the [Overlays] tab of the Layers menu.

3. Enter a name (max. 25 characters) and comment (max 200 characters) and tap the checkmark.

Note: Do NOT add any personal information.

4. Tap [Rating] to rate the mooring (1 to 5 stars). Tap [<] on the title bar to go back to the [Create a Mooring] display.
5. Tap [Create].

When a mooring is created, the background appears in yellow and changes to white when confirmed.



Mooring forecast

Enter the period of time for mooring. The weather forecast for that period is used to provide wind protection.



Note: The TZ weather data is required for mooring forecast (see chapter 14).

1. Tap [Today] to set the desired date, then tap [OK].
2. Tap [from] to set the start time, then tap [OK].
3. Tap [to] to set the end time, then tap [OK].

Mooring mark

The color of the mooring mark depends on the weather conditions.

Color	Meaning
Green	The ship can be safely moored.
Orange	The waves are present but calm, indicating that mooring is possible.
Red	The location is dangerous for mooring.
Grey	Calculating wind information.
Purple	Wind information cannot be calculated.

If the ship is moored near the coast, the following information is displayed in addition to the mooring mark.

Rounded line indicates relatively safe locations that are less likely to be influenced by wind or waves when moored.



Indicates wind direction (color indicates safeness status, same classification as mooring mark (see the table above)).

2.16.4 How to set up display information for chart objects/mooring

1. Home page→[Settings]→[Chart Plotter].
2. Turn [Display Community Tags], [Highlight New Object], [Display Proximity Pop-up] on or off, referring to the description below.

[Display Community Tags]: “On” displays all marks (comments, ratings, etc.) displayed on the created chart object/mooring. “Off” hides marks other than *.

[Highlight New Object]: “On” highlights newly created chart objects/mooring.

[Display Proximity Pop-up]: “On” highlights, the applicable object and a message similar to the one shown below appears when your ship approaches within 250 m of a chart object/mooring created by another user. Tap an appropriate option in the message, referring to the description in the figure below.



You can also report if you are unsure of the correct position by tapping the highlighted chart target and using the Pop-up menu that appears.

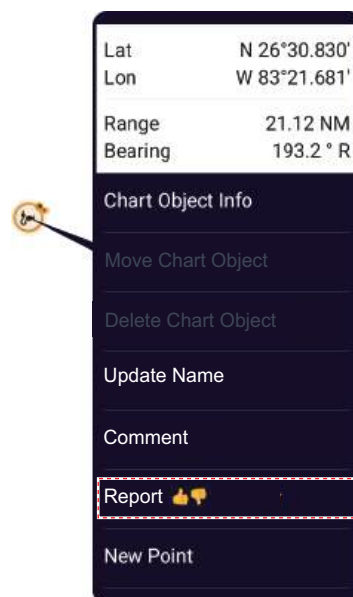

3. Tap [x] on the title bar to finish and close the menu.

2.16.5 How to edit chart object/mooring information

You can edit both newly created chart objects/moorings and existing chart objects/moorings.

1. Tap the chart object or mooring to edit. Below figure is an example of chart object.

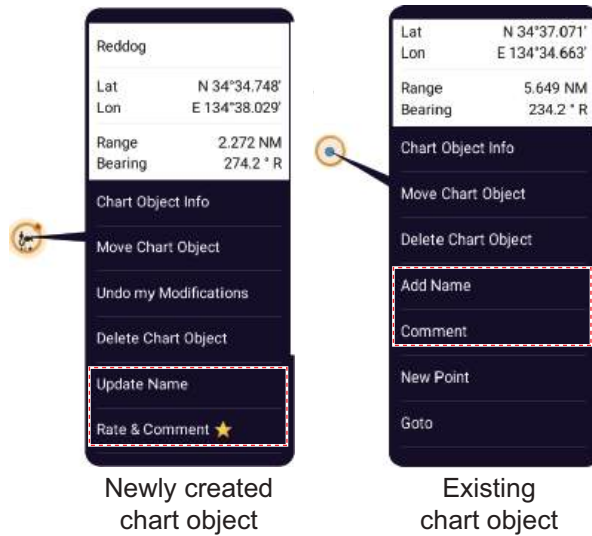

2. Tap [Update Name]. If there is no name, [Add Name] appears in place of [Update Name].

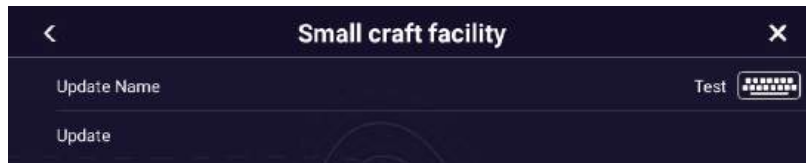

3. Tap [Update Name] or [Update]. Enter name (max. 25 characters), then tap [✓]. To enter a comment, go to step 4. Otherwise, go to step 6.

Note: Do not enter personal information.

4. Tap [Comment], or [Rate & Comment] in case a comment exists.
5. Enter comment, using a maximum of 200 characters, then tap [✓]. If necessary, change the rating.

Note: Do not enter personal information.

6. Tap [Update] to save changes and finish.

For an existing chart object, the symbol shown in the figure below appears when a name is entered.



2.16.6 How to move a chart object/mooring

You can move both newly created chart objects/moorings and existing chart objects/moorings.

1. Tap the chart object/mooring to move. Tap [Move Chart Object] or [Move Mooring] on the Pop-up menu. The “move” icon appears below the chart object/mooring as shown in the figure at right.
2. Drag the icon to the position desired, or tap the position desired. “*” (at the top right of the target) changes to →.
3. Tap [End Move] (top right corner) to anchor the chart object/mooring. The message "YOU ARE ABOUT TO MOVE A CHART OBJECT/MOORING. THIS MODIFICATION WILL BE VISIBLE BY ALL USERS USING THE COMMUNITY MAPS LAYER. ARE YOU SURE?" appears.
4. Tap [OK]. For created chart objects/moorings, and asterisk (*) at the top right of the chart object/mooring reappears. For existing chart objects/moorings, the original position and the new position are connected with a line and an arrow (→) appears at top-right corner of the symbol.



2



2.16.7 How to delete a chart object/mooring

You can delete both newly created chart objects/moorings and existing chart objects/moorings.

1. Tap the chart/mooring object to delete. Tap [Delete Chart Object] or [Delete Mooring] on the Pop-up menu. The message "YOU ARE ABOUT TO DELETE A CHART OBJECT/MOORING. THIS MODIFICATION WILL BE VISIBLE BY ALL USERS USING THE COMMUNITY MAPS LAYER. ARE YOU SURE?" appears.
2. Tap [OK] to delete the object/mooring and close the window.

2.16.8 How to undo a modification

When editing a chart target/mooring, you can cancel the operation and return to the previous state.

1. Tap the chart object/mooring to restore its previous state. Tap [Undo my Modifications] on the Pop-up menu. The message "YOU ARE ABOUT TO UNDO YOUR MODIFICATION ON THIS CHART OBJECT/MOORING. THIS MODIFICATION WILL BE VISIBLE BY ALL USERS USING THE COMMUNITY MAPS LAYER. ARE YOU SURE?" appears.
2. Tap [OK] to undo the modification and close the window.

2.16.9 How to display chart object/mooring information

Tap the chart object/mooring for which you want to display its information, then tap [Chart Object Info] on the Pop-up menu.

FISHING SPOT	
Name	R
EDIT	
Update Name	
Rate & Comment	★
COMMENTS	
David M	A few minutes ago. D
CHANGES HISTORY	
added	A few minutes ago. by David M. Under validation.
SYNCHRONIZATION STATUS	
Synchronized	
EXCLUSIVE ECONOMIC ZONE	
Nationality	United States
Source date	Friday, February 1, 2013
Indication	US,US,graph,Chart 11420
DEPTH AREA	
Dpth Rng 1	36.5 m
Dpth Rng 2	54.8 m
NAUTICAL PUBLICATION	
Source date	Saturday, July 16, 2005
Indication	US,US,graph,Chart 11420
SEA/NAMED WATER AREA	
Name	Gulf of Mexico
Source date	Friday, February 1, 2013
Indication	US,US,graph,Chart 11420

NAVIGATIONAL SYSTEM OF MARKS	
Mark system	IALA B
Source date	Saturday, July 16, 2005
Indication	US,US,graph,Chart 11420
QUALITY OF DATA	
Category	zone of confidence C
Date - end	Thursday, January 1, 1959
Date -start	Sunday, January 1, 1950
CHART PROPERTIES	
Chart Type	Vector Chart
Chart Manufacturer	Mapmedia
Scale	350000
Edition Date	Monday, August 28, 2023
Revision Date	Monday, May 22, 2023
Edition Number	44
Revision Number	2
POINT INFO	
Position	N 26°30.830'; W 83°21.681'
Range	12.95 NM
Bearing	201.8 °
MM4 Tile Id	L16_R37745_C17592

2.17 TZ iBoat

Using the "TZ iBoat" application on your iPhone/iPad allows you to share user objects (points, routes, boundaries (areas, lines, circles), photos, and catches) between your iPhone/iPad and the TZMAP9/13 or TZT9E/13E. For the operation by using TZiBoat, refer to the manual created by Nobeltec.

Note 1: Use the TZiBoat application when logged into your My TimeZero™ with the account created by the TZMAP9/13 or TZT9E/13E (see section 1.21).

Note 2: If your smartphone or tablet with application installed is stolen, not only can the user's information be viewed, but there is also a risk of unauthorized access to the device. See the following security considerations:

- Keep your smart device near to you to avoid the risk of theft.
- Use the screen lock function (for example, PIN code) or password for authentication in your smart device.
- Make sure the password is long enough, including numbers and uppercase letters.
- If unauthorized access from a smart device is suspected, disable the communication.
 - 1) Select Home Page→[Settings]→[Initial Setup]→[Data Sensors]→[Sensor List]. See page 16-7 for details.
 - 2) Select the device from the list.
 - 3) Select [Permission to use] and disable the connection. If a password is registered, enter the password to disable.

2.18 TZ First Mate

TZ First Mate is a smartphone, tablet fishing record application. You can record photos of catches, types of catches, fish lengths, and fish weights of the fish you catch. By logging in to My TimeZero™ using the account created by the TZMAP9/13 or TZT9E/13E, you can share photos and fishing data between the TZ FirstMate™ application and the TZT9E/13E or TZMAP9/13.

Note 1: See section 1.21 for how to login to your My TimeZero™ account.

Note 2: Before opening the application, connect your smartphone, tablet with your wireless LAN network (see section 1.20).

Note 3: For the security considerations, see section 2.17.

How to register catches

Catches (see "Log Catch" on page 4-4 for information) can only be entered from your TZT9E/13E.

How to share photos

Photos taken with your smartphone, tablet can be shared with your TZT9E/13E or TZ-MAP9/13 and displayed on the chart plotter display. The photo location is shown on the chart plotter display with the photo icon ().

2.19 Photos

Screen-captured images and photos taken with the smartphone/tablet application TZ First Mate™ can be shown on the chart plotter display. See section 2.17.

Note: Before opening the application, connect your smartphone/tablet with your wireless LAN network (see section 1.20).

How to import photos

See section 11.4 for how to import photos from a storage medium into the internal memory. Imported photos appear on your plotter screen with the photo icon ().

You can check how many photos are stored on your TZT9E/13E or TZMAP9/13 Go to the Home page, then select [Settings]→[General], then scroll the menu to show the [DATA USAGE] section.

Points	15 / 30000
Routes	3 / 200
Areas & Lines	0 / 100
Circles	0 / 100
Photos	91 / 1000
Catches	0 / 1000
Track Points	228 / 100000

At the [Photos] line, “currently saved photos” / “total available photo storage” indicates the total number of photos versus the total available space for photos. In the example, above a total of 91 photos out of 1000 are stored.

How to move a photo on-screen

1. Tap the photo you want to move, then select [Move] from the displayed Pop-up menu. The move icon appears at the selected photo location, similar to the figure shown to the right.
2. Drag and drop the icon to the new location, or tap the new location on-screen.
3. Tap [End Move] at the top-right corner of the screen to anchor the photo symbol and finish.



2. CHART PLOTTER

How to show the Photos list

Home page→[Lists]→[Photos].

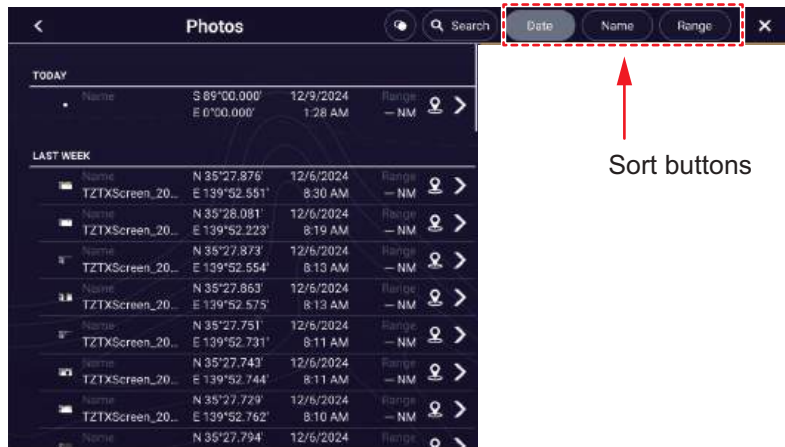

To sort or search the list, see section 4.7.

How to edit photo information

You can edit photo information from the information screen. Tap the photo to process to show the information screen.

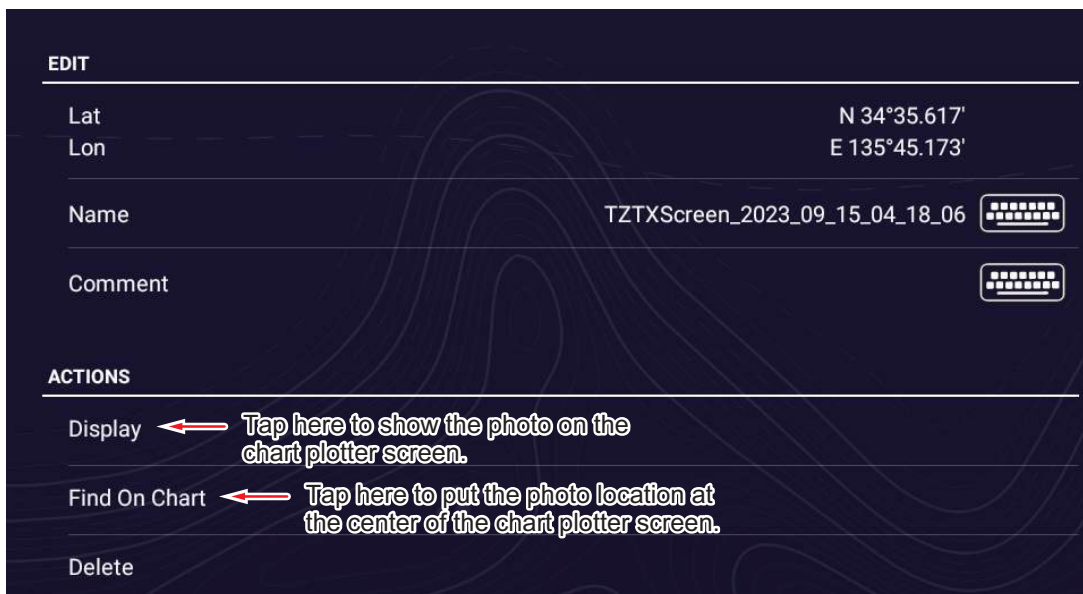

Editing is done with one of the following methods:

- Tap the photo icon to show the Pop-up menu, then select [Edit].
- Select the photo you want to edit from the [Photos] list.

Referring to section 4.10.1, edit the coordinates, name and comment of the photo as required.



How to delete photos via the menus

You can delete photos with one of the methods:

- **Individual photo, Pop-up menu:** Tap the photo icon to show the Pop-up menu, then select [Delete].
- **Individual photo, via menu:** Select [Delete] from the [Edit] menu.
- **Delete all photos, via menu:** Home page→[Settings]→[Points & Boundaries]→[Delete All User Objects]→[OK]. (See subsection 4.9.4 and section 5.7.4.)

How to edit, delete photos collectively via the Photos list

1. Home page→[Lists]→[Photos].
2. At the top of the [Photos] list, choose how to sort the photos.
3. Tap the  icon. In the example list below, the photos are sorted by date.

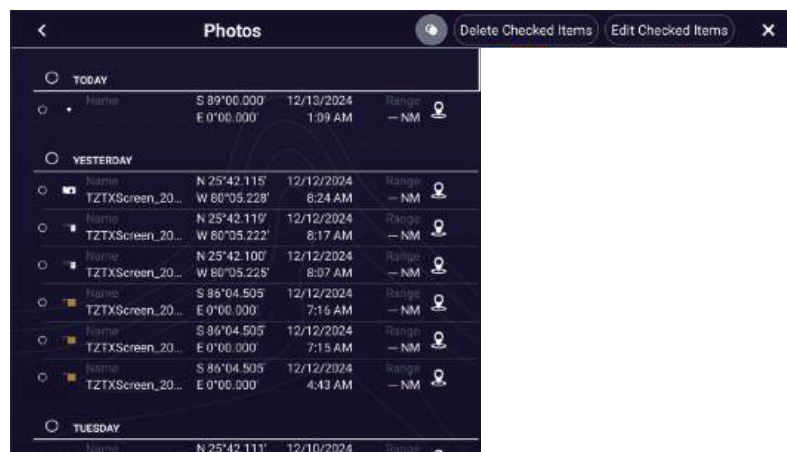

4. Tap the hollow circle to the left of the photo(s) to edit or delete to fill the circle in white, or check a sort title to edit or delete all photos within that title.
5. Do one the following:
 - Delete:** Tap [Delete Checked Items]. A message asks if you are sure to delete checked photos. Tap [OK] to delete the photos. Tap [x] to finish and close the list.
 - Edit:** Tap[Edit Checked Items]. The window shown below appears.

6. Tap the item to edit ([Name], [Comment]) and edit as necessary.
7. Tap [Save & Close] to save changes and finish.

2.20 Fleet Tracking

The fleet tracking function, which requires internet connection, lets you see the status (position, speed, etc.) and user objects (points, routes, boundaries, photos, catch log, etc.) of ships belonging to the same fleet tracking group as own ship.

Note 1: To use this feature, you need to create a My TIMEZERO™ account (see section 1.21) and register fellow sister ships in the same fleet.

Note 2: Only PCs with TIMEZERO™ Professional version 4.1 or later can send user object data to sister ships in the same fleet.

Note 3: To display the MMSI and boat name in the information, set the MMSI and boat name in the [Boat Information] menu of the [Initial Setup] menu. See the Installation Manual for details. If connected to the FA-30/40/50 AIS Transponder, the MMSI and boat name are automatically displayed in the above-mentioned menu.

2.20.1 How to set up fleet tracking

1. Home page→[Settings]→[My TIMEZERO].
2. Turn on [Report Position to My TIMEZERO].
3. Tap [Report Interval], then set how often to report your boat's information to the fleet tracking system.
4. Tap [×] to finish and close the menu.

2.20.2 How to show/hide fleet target (sister ship) symbols

In the chart plotter mode, open the Layers menu, then tap the [Overlays] tab. Turn on [Fleet Targets] to show fleet targets, or turn off to hide them. The figure below shows the appearance of the fleet target symbol.



2.20.3 How to show fleet target information

Tap a fleet target symbol to show the target's basic information, in the Pop-up menu. For detailed information, tap [Info] on the Pop-up menu.

Name	Furuno NavNet
HDG	7.6 °M
SOG	0.0 kn
Range	7,511 NM
Bearing	282.3 °M
CPA	7,275 NM
TCPA	---
Last Update	18h58'
Info	
Reset Target	

Basic Information

Furuno NavNet	
<p>ACTIONS</p> <p>Find On Chart</p>	
<p>TARGET INFO</p> <p>Nickname</p> <p>Color</p> <p>Boat Name</p> <p>MMSI</p> <p>HDG 7.6 °M</p> <p>SOG 0.0 kn</p> <p>Depth — ft</p> <p>Wind Speed — kn</p> <p>Wind Dir — °</p> <p>Range 7,511 NM</p> <p>Bearing 274 °</p> <p>Vessel Length 39.4 ft</p> <p>Vessel Width 13.1 ft</p> <p>Lat N 34°44.450'</p> <p>Lon E 135°21.280'</p> <p>User Name Furuno NavNet</p>	

Detailed Information

2.20.4 How to clear fleet target symbols temporarily from the screen

You can temporarily clear any fleet target from the chart plotter display and fleet target list (see section 2.20.5) until new information is received, at the interval set with [Report Interval] in the [General] menu. Tap the fleet target you want to delete to open the Pop-up menu, then tap [Reset Target].

2.20.5 Fleet target list

Fleet target information is stored in the [Fleet] list. You can check and edit the information of consort ships. The [Fleet] list stores the following data for each fleet target:

- Nickname
- Color of fleet target
- Boat's name
- MMSI
- COG/SOG
- Depth
- Wind speed and direction
- Range and bearing to own ship
- Ship's length and width
- Position (latitude and longitude)
- User name (My TimeZero™ login name)
- Date (date registered)
- Day of update (day of last update)

1. Home page→[Lists]→[Fleet].

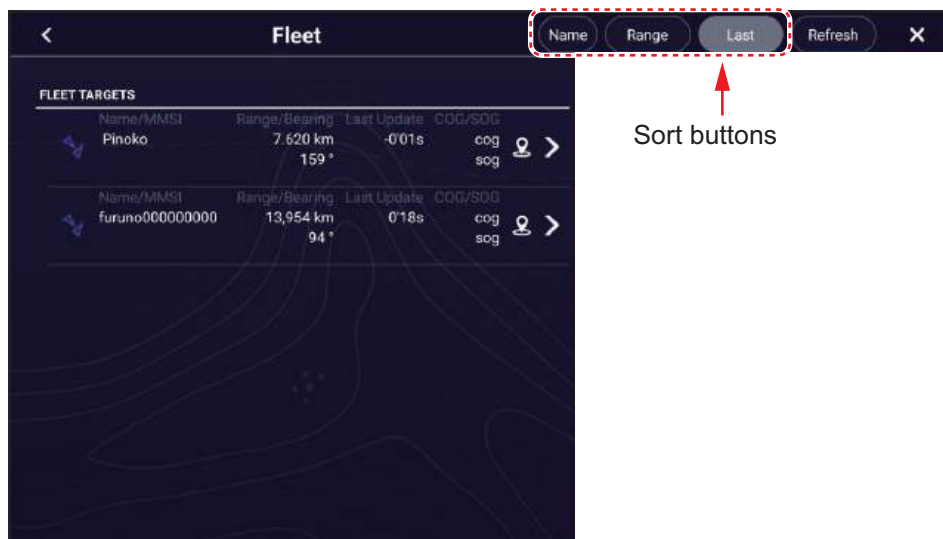

2. To sort or search the list, follow the applicable procedure below.

How to sort the Fleet list

Tap the appropriate sort button on the title bar.

[Name]: Sort the list in alphabet order.

[Range]: Sort the list in ascending order by distance from own ship.

[Last]: Sort the list by latest update.

How to search the Fleet list

You can search the list by alphabet.

a) Tap [Name] on the [Fleet] list.

b) Tap the alphabet of each fleet target.

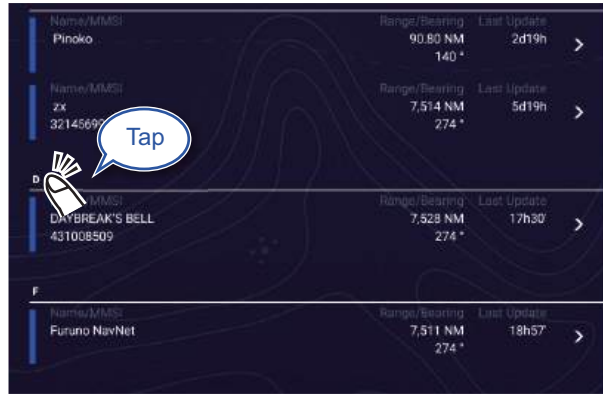

The search screen appears, and the searchable alphabets are displayed in blue.



3. Tap the fleet target to check or edit. Information for the target selected appears.

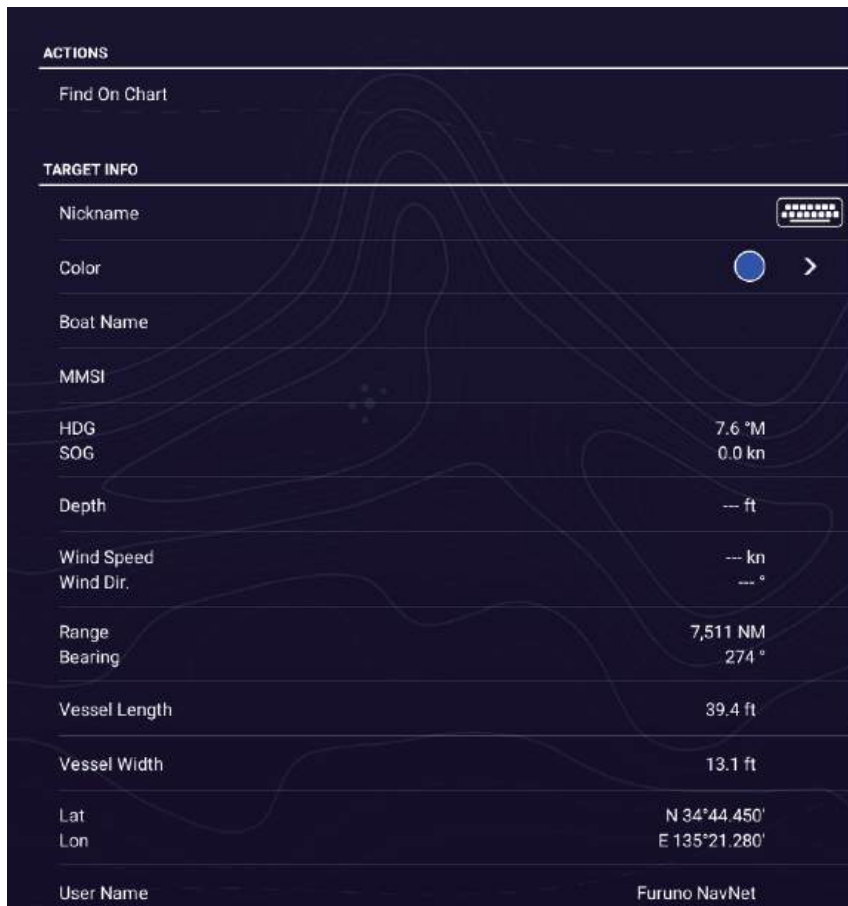

2. CHART PLOTTER

4. To edit a fleet target, follow the appropriate procedure below.

Edit a nickname

- 1) Tap the letter to change in a nickname.
- 2) Use the software keyboard to edit the nickname.
- 3) Repeat steps 1) and 2) to continued editing. A nickname can have a maximum of 32 characters.
- 4) Tap [×] to finish and close the menu.

Change the color of a fleet target symbol

- 1) Tap [Color].
- 2) Select a color, then tap [<] on the title bar to go back one layer in the menu.
- 3) Repeat steps 1) and 2) to continued editing. A nickname can have a maximum of 32 characters.
- 4) Tap [×] on the title bar to finish and close the editing window.

2.20.6 How to put a fleet target at the center of the chart plotter display

Tap the fleet target that you want to put at the center of the screen. Tap [Find on Chart].

2.20.7 How to share user objects

When you receive a user object from a fleet target, the message "Fleet: user Object received from..." appears.

Note: You can receive a maximum of 92 user objects. See section 11.3 for details.

2.21 Fish-It

The [Fish-It] function is used to start drift fishing aiming at a specific point such as an ACCU-FISH icon (see section 6.15) or a log catch icon (see section 4.2.2). Since you can see information such as the distance and direction to the target point, it is convenient when you are fishing with the engine off.

Note: The [Fish-it] calculation does not consider obstacles in the drift path. Be careful of any obstacles within the drift path.

How to show the Fish-It item in the Pop-up menu

To display the [Fish-It] menu item in the Pop-up menu, which appears when you tap a point, event mark, etc. on the chart plotter screen, follow the procedure below. Note that the [Fish-It] menu item appears for the ACCU-FISH icon and catch mark regardless of this menu setting.

1. Home page→[Settings]→[Chart Plotter].
2. Turn on [Show Fish-It on Pop-up menu].
3. Tap [×] on the title bar to finish and close the menu.

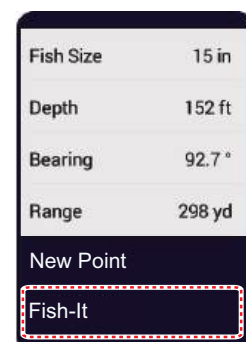

Pop-up menu for ACCU-FISH icon

How to use Fish-It

1. On the chart plotter display, tap the location (point, etc.) where you want to fish.
2. Tap [Fish-It] on the Pop-up menu.

Range rings appear, centered on the vessel icon. The waypoint is marked with the  icon, and own ship and the waypoint are connected with a solid yellow line. Also, ship's track is shown.

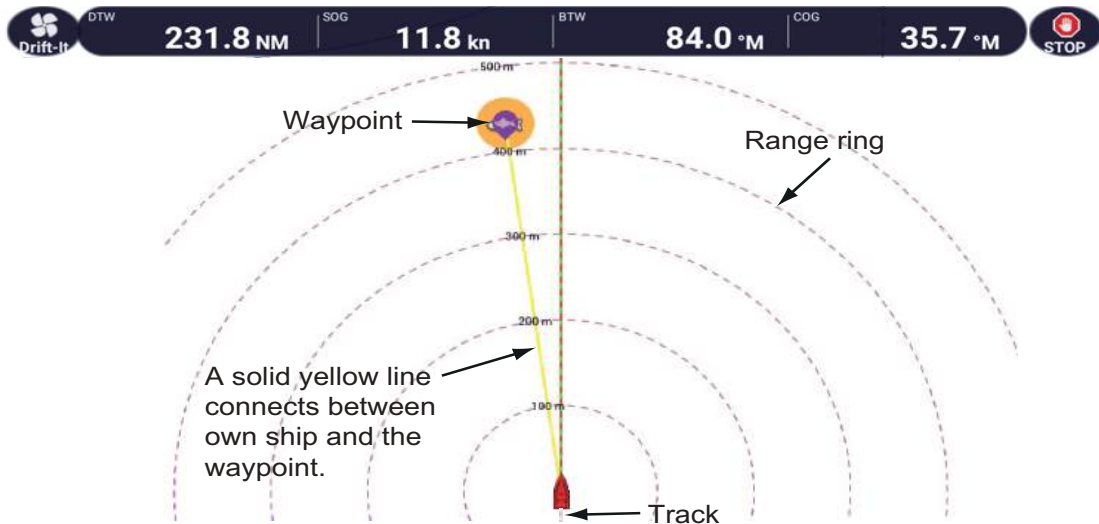

Note 1: Speed must be six knots or less to use the feature. When speed exceeds six knots, a message appears and the function is stopped.

Note 2: The maximum radius of the range ring depends on the setting for [Short/Long Changeover] in the [Units] menu. See section 16.2.

The Navigation bar appears, showing the following information.

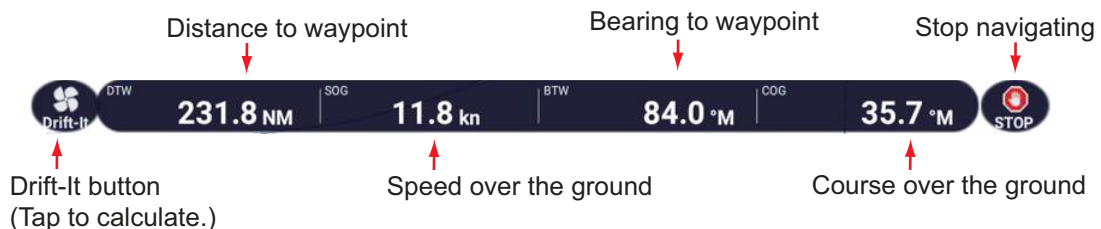

3. Before activating the drift function, cut your engines and wait until forward momentum has subsided. (If engine(s) are not turned off before tapping the icon, a message asks you to turn off your engine(s).)

Tap the [Drift-It] icon () on the Navigation bar to activate the drift function.

2. CHART PLOTTER

Note that you can also use the Pop-up menu to activate the drift function. Tap the fish icon or yellow line to show the Pop-up menu, then tap [Start Drifting].

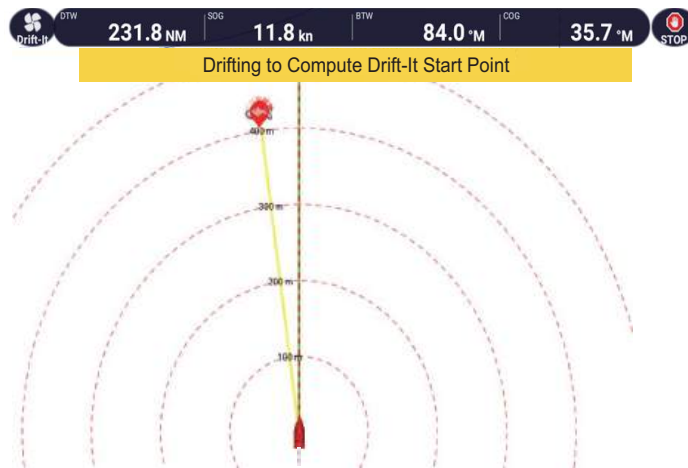

The message "Drifting to Compute Drift-It Start Point" appears at the top of the display. After your boat has drifted 30 meters, the message "Drift it Start Point Computed" appears, indicating completion of computation, then [Drift-It] is automatically turned off.

When the engine is off, the ship drifts under the influence of wind and tides, making it difficult to reach its destination. With the Drift function, drift data is accumulated while it is on, and when deactivated after a few minutes, the purple icon indicates from which point to start drift fishing based on the accumulated drift information.

Note: To cancel [Drift-It], tap the [Drift-It] icon () at the top of the display. The message "YOU NEED TO BE DRIFTING FOR ABOUT 100FT BEFORE THE DRIFT-IT START POINT CAN BE COMPUTED. WHAT WOULD YOU LIKE TO DO?" Tap [Cancel Drift-It] to stop, or tap [Resume Drift-It] to continue.

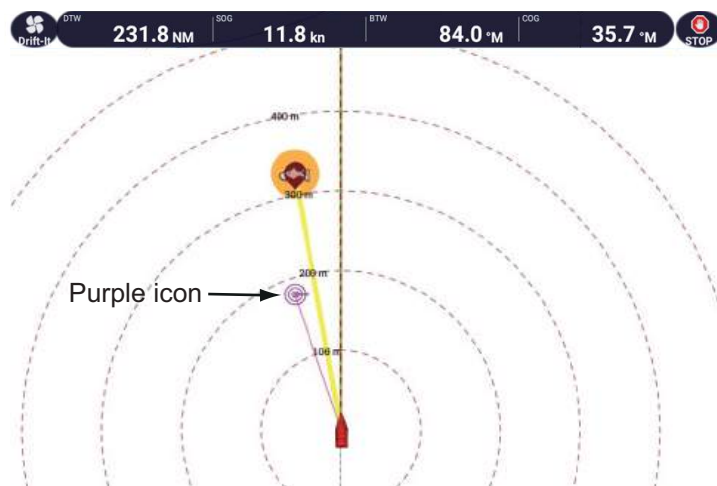

4. Tap the purple icon. A Pop-up menu similar to the one shown below appears.

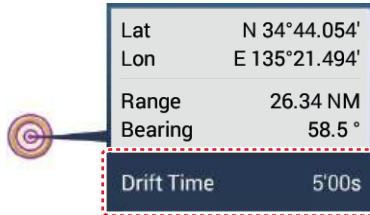

5. Tap [Drift Time], then select desired drift interval, among 3'00s, 5'00s, 10'00s, 15'00s, and 20'00s.
If necessary, repeat steps 3 to 5.
6. To deactivate this function, tap the [STOP] icon on the Navigation bar.
The [Fish-It] function can also be deactivated from the Pop-up menu or the corresponding fish icon. Tap the fish icon or the yellow line, then, tap [Stop Fish-It] on the Pop-up menu.

2. CHART PLOTTER

This page is intentionally left blank.

3. 3D DISPLAY, OVERLAYS

3.1 3D Display

The 3D display has native 3D chart design that allows full-time 3D presentation. This true 3D environment gives you all of the information you require with no restrictions on the information you can see. You can plan your routes, enter points, etc. like on the 2D chart.

The 3D display provides a 3D view of land and sea around your ship. The display has most of the same information as the 2D display. With both presentations available you can see the conditions around your ship from different viewpoints. The 3D display helps you navigate when you are in waters that you do not know. Most functions of the 2D display, for example, destination setting, are available in the 3D display.

3

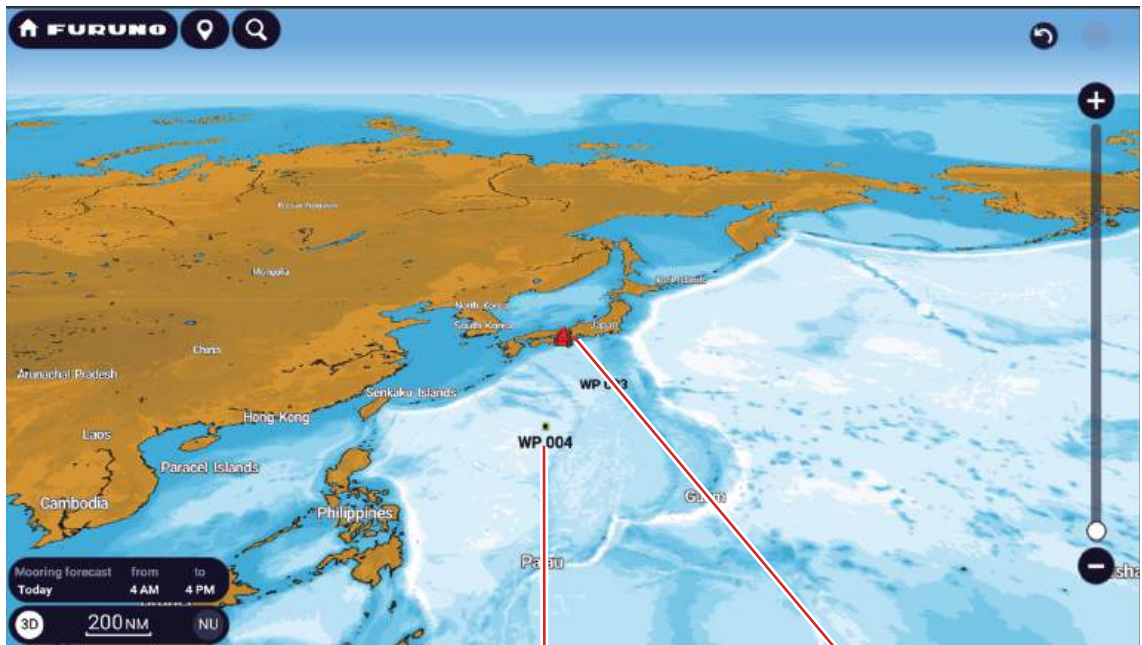

Point

Own ship icon
(your ship)

3D display

3.1.1 How to activate the 3D display

1. To switch between the 2D and 3D displays, tap the 2D/3D switch at the bottom left corner on the screen or drag upward/downwards as shown below. The icon is filled in white when the 3D display is active.

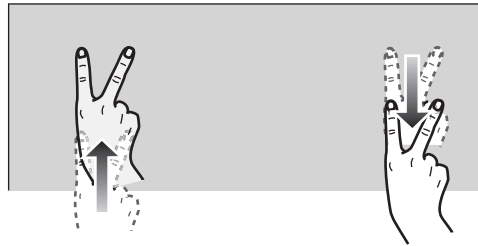

Drag upwards: 2D→3D Drag downwards: 3D→2D

2. Tap the orientation mode switch to select an orientation mode.
3. Orientate the 3D display by dragging leftward or rightward with two fingers.

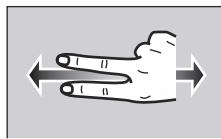

The 2D/3D display switch, orientation mode switch

The 2D/3D display switch alternates the 2D and 3D displays. The orientation mode switch selects the orientation, North up or Head up. In the North up mode, North is at 0°. When you change the viewpoint on the 3D display, the orientation mode switch shows the "North" icon. The arrow on the icon points toward North. To switch to North-up orientation, tap the switch.

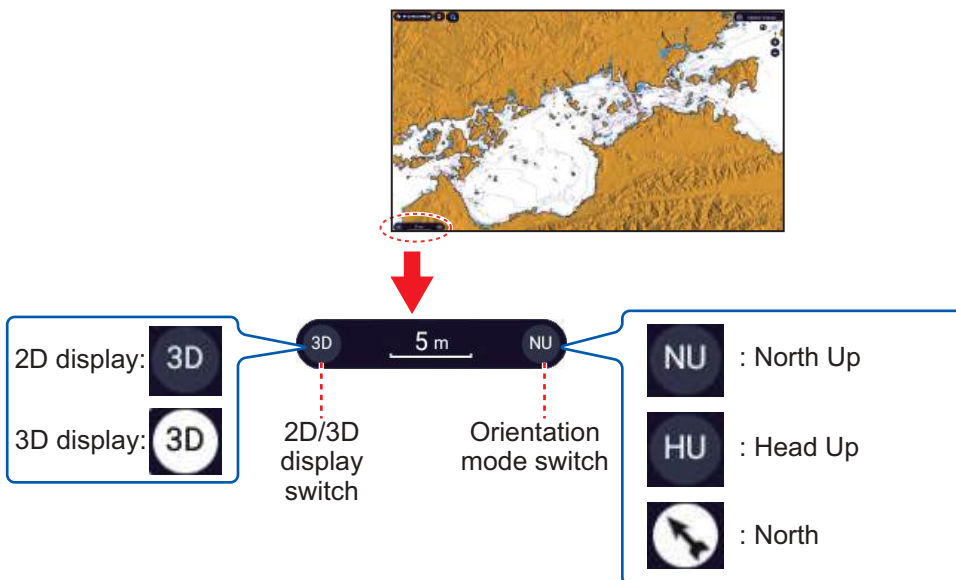

3.1.2 How to make the 3D view clearer

In the 3D view, the features of the terrain can be more easily recognized by using the emphasis function. The emphasis function has two settings, automatic and manual. Select one following the procedure below.

1. Home page→[Settings]→[Chart Plotter]→[3D Display].

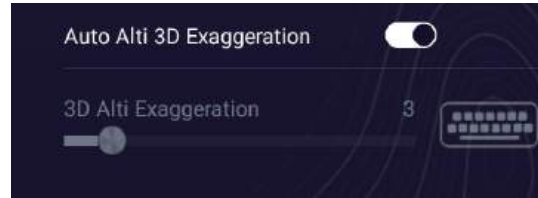

2. Automatic method:

Turn on [Auto Alti 3D Exaggeration].

Manual method:

Turn off [Auto Alti 3D Exaggeration]. Use the slider bar or software keyboard for [3D Alti Exaggeration] to set the exaggeration level.

High gives the highest level of exaggeration. The example below compares the same picture in low and high exaggerations.



Low exaggeration

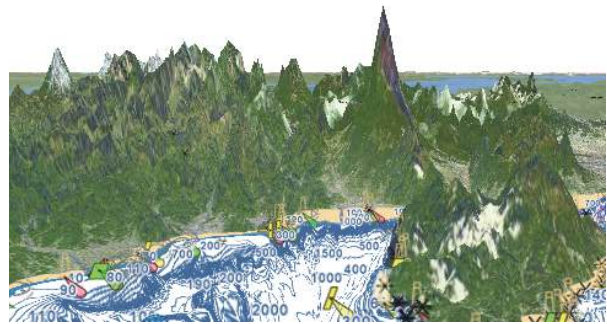

High exaggeration

3. Tap [×] on the title bar to finish and close the menu.

3.2 Overlays

Six overlays are available for the chart plotter display: depth shading, satellite, radar, sonar (for TZT9E/13E only), tide information, ACCU-FISH™ icon, and tidal current.

3.2.1 Depth shading overlay

The depth shading overlay shows the depths in different colors (the default settings are red (shallow), yellow (medium) and blue (deep)). This overlay is available in both the 2D and 3D presentations, and is useful for finding depths. To show the depth shading overlay, open the Layers menu, tap the [Charts] tab, then turn [Depth Shading] on.

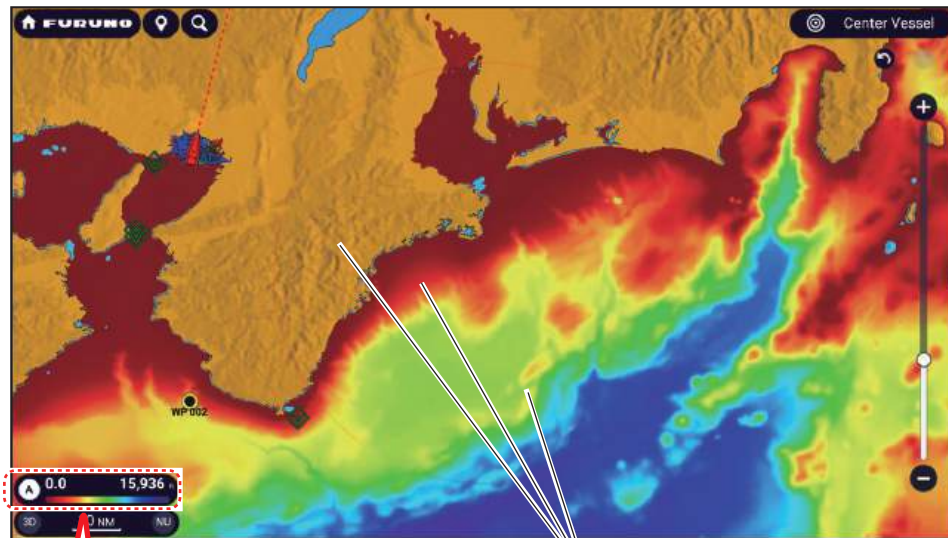

Depth shading

Minimum value
Maximum value

Manual mode

Auto mode

A

0.0

4,857_m

You can turn the automatic depth shading color scale adjustment on or off (auto, manual) by tapping the "A".

Automatic mode:
 Depth shading is set according to the depth shading values set in the menu ([Settings]→[Chart Plotter]→[Depth Shading Values]).

Manual mode:

- 1) Tap the minimum value (maximum value) at left side (right side) of scale.
- 2) Use the slider bar at right side of screen to set value.
- 3) Tap [Done] to complete.

Depth shading settings

The depth shading settings are in [Settings]→[Chart Plotter]→[Depth Shading Values].

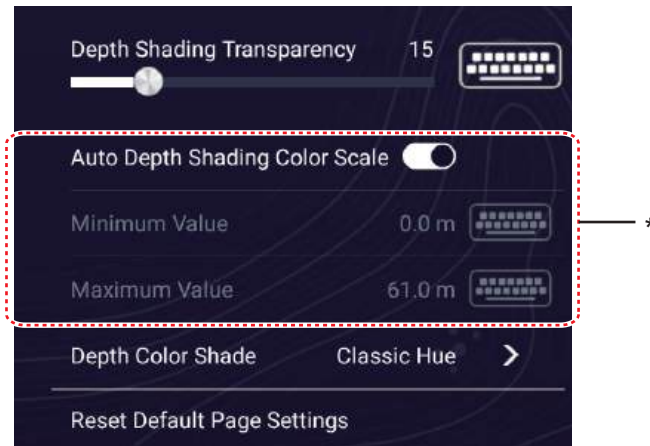

*: Can also be set with the depth shading color scale (see preceding page).

[Depth Shading Transparency]: You can adjust the transparency level to make it easier to see the chart data hidden under the depth color. Use the slider bar (or the software keyboard) to adjust the transparency level (setting range: 0 to 80%).

[Auto Depth Shading Color Scale]: Turn automatic depth shading color scale selection on or off.

[Minimum Value]: Set the minimum depth range for which to show depth shading, with the software keyboard. This is available when [Auto Depth Shading Color Scale] is turned off.

[Maximum Value]: Set the maximum depth range for which to show depth shading, with the software keyboard. This is available when [Auto Depth Shading Color Scale] is turned off.

[Depth Color Shade]: Select how to display the depth colors among [Classic Hue], [Inverted Classic Hue], [Red Hue], [Blue Hue], [Green Hue], [Yellow Hue], and [Deep Blue].

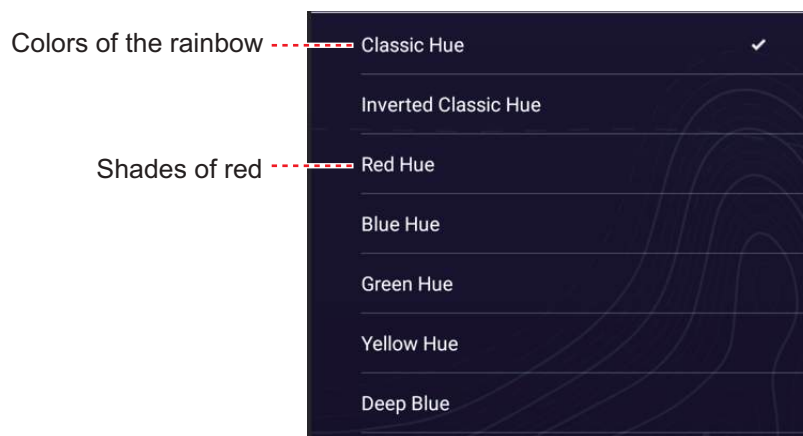

[Reset Default Page Settings]: Reset the items in the [Depth Shading Values] menu to default.

3.2.2 Satellite photo overlay

You can put the satellite photo for your area on the 2D and 3D displays. Open the Layers menu, tap the [Overlays] tab, then turn [Satellite Photo] on or off.

High resolution satellite images for the USA coastline are not provided standard, but are available online for download at no cost. The illustration below shows the vector chart with the satellite photo overlay.

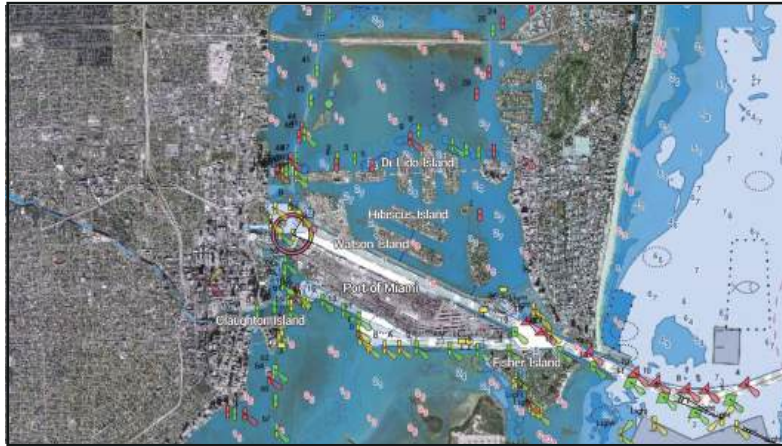

How to set satellite photo transparency on water

You can set the degree of transparency for the satellite photo on the water.

1. Home page→[Settings]→[Chart Plotter].
2. Tap [Transparencies], then use the slider bar for [PhotoFusion Transparency] to set the degree of transparency (setting range: 0% to 80%).
3. Tap [x] on the title bar to finish and close the menu.

3.2.3 Radar overlay

The radar overlay display, which requires a radar sensor, and heading and position inputs, puts the radar picture on the top of the navigation chart. To display the radar overlay, open the Layers menu, tap the [Overlays] tab, then turn on [Radar Overlay].

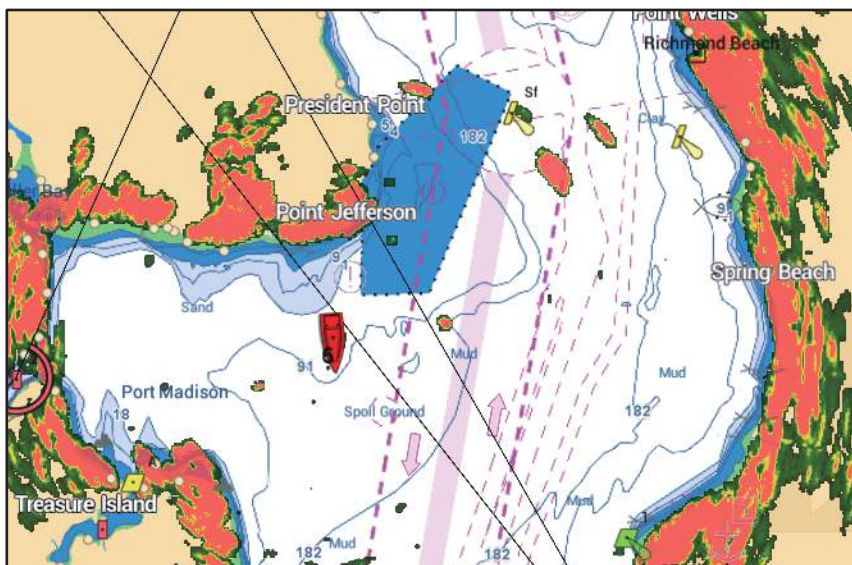

How to switch between stand-by and TX, sync overlay and radar ranges

Switch between stand-by and TX: Tap the [TX] icon at the bottom-left corner to set the radar in transmit or stand-by state. The icon is filled in white when the radar is transmitting; blue in stand-by.

Sync overlay and radar ranges: Home page→[Settings]→[Chart Plotter], then turn [Range Link] on or off as appropriate. With [Range Link] turned off you can sync the ranges manually, with the Sync button at the bottom-left corner.

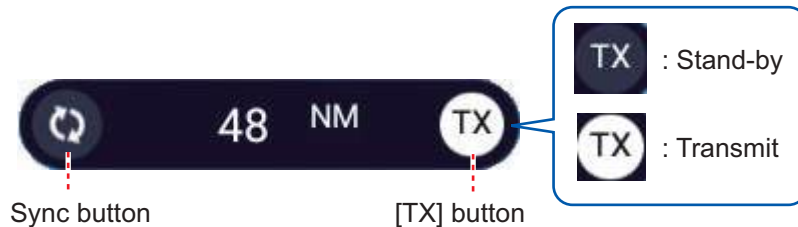
**How to show radar rings**

To show the radar rings on the chart plotter display, [Layers] menu→[Overlays] tab→turn on [Radar Rings].

How to set the level of the radar echo transparency

Home page→[Settings]→[Chart Plotter]. Tap [Transparencies], then use the slider bar for [Radar Transparency] to set the degree of transparency.

How to adjust radar gain, sea, rain

The gain and sea and rain clutters can be adjusted from the navigation data display. See sections 7.4 - 7.6.

How to select the echo color

Home page→[Settings]→[Chart Plotter]→[Radar Overlay]→[Echo Color]. Tap [Multicolor], [Green], or [Yellow]. [Multicolor] colors echoes red, orange or yellow in order of descending strength.

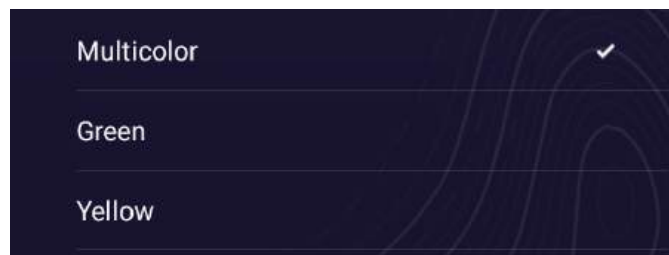
**How to acquire a target for ARPA**

A target can be acquired for ARPA. See subsection 7.26.2.

3.2.4 Sonar overlay (TZT9E/13E only)

The sonar overlay display, which requires the CSH-10/heading sensor and position inputs, puts the sonar picture on the top of the navigation chart. To display the sonar overlay, open the Layers menu, tap the [Overlays] tab, then turn on [Sonar Overlay].

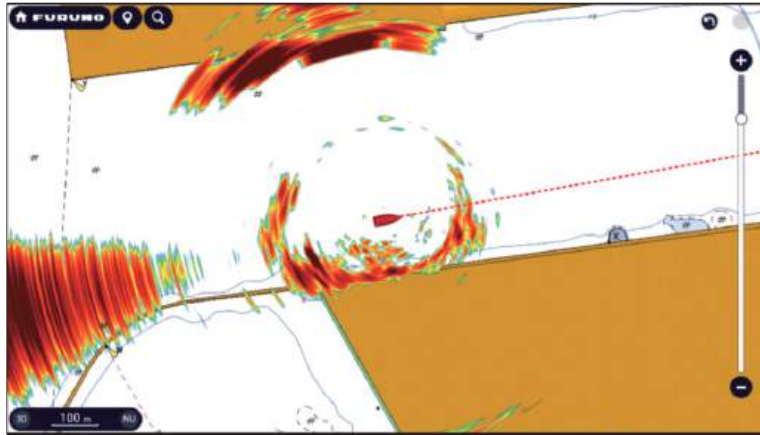

How to display the sonar rings

To display the sonar rings (see section 10.1), open the Layers menu→[Overlays] tab, then turn [Sonar Rings] on.

3.2.5 Tide heights overlay

Your system carries worldwide tide heights information, shown with tide icons, which you can overlay on the chart plotter display. The tide icon (📏) appears at the locations of tidal recording stations.

How to display the tide heights overlay

Layers menu→[Overlays] tab, then turn [Tide Heights] on.

The arrow on the tide icon points upward or downward with tide direction. The tide icon is gray and yellow according to the tide state. The tide icon is all yellow when the tide is high completely and all gray when the tide is low completely.



Tide height icon
(yellow and/or
gray)

- ↑ : Up arrow indicates the tide is going high.
- ↓ : Down arrow indicates the tide is going low.
- : No arrow indicates no change in tide.

How to change the size of the tide icon

1. Home page→[Settings]→[Chart Plotter].
2. Use the slider bar or software keyboard for [Tide/Current Icons Size] to set size (setting range: 50% to 150%).
3. Tap [x] on the title bar to finish and close the menu.

How to show the tide heights information

Tap a tide icon to display the tide height graphic in a context-sensitive window, an example of which is show in the right-hand figure.

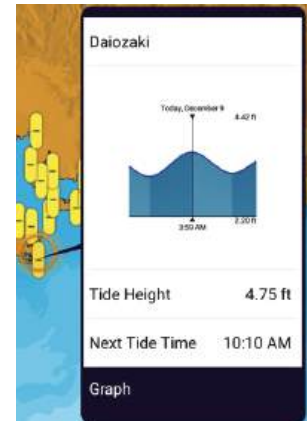

How to display the tide graph

- **Display tide graph for a tide station:** Tap a tide icon then tap [Graph].
- **Display tide graph for the tide station nearest the selected position:** Tap the desired position on the chart, then tap [Tide]. If a tide station is not within 35 NM of the location tapped, the tide graph does not appear.
- **Display tide graph for the tide station nearest current position:** Open the Slide-out menu, then tap [Tide].



How to read the tide graph

Note: Forecasts are calculated based on mild weather conditions. Expected tidal times and tidal levels are dependent on the influence of storms and fronts.

- Vertical axis: Height, Horizontal axis: Time
- The information is mostly accurate under moderate weather conditions. However, storms and weather fronts can influence forecasted tide times and heights.
- Drag the time scale at the bottom of the screen sideways then read the tide height at the selected time (drag to the left to display the future information, right for the past information).
- To set the time scale to the current time, tap the clock icon at the bottom left-hand corner of the screen. The color of the clock mark turns gold.



Clock icon for the current time



Clock icon other than the current time

- To return to the chart plotter display, tap [x] on the title bar.

3.2.6 Tidal currents overlay

In North America, the tidal current data from NOAA can be overlaid on the chart plotter display.

How to display the tidal currents overlay

Layers menu→[Overlays] tab, then turn on [Tidal Currents]. Tidal current icons (arrows) of more than one color appear on the screen and are pointing in various directions.



Tidal current icon

The arrows point in the direction of tidal current movement. The color of the arrows indicate the tidal current speed:

- Yellow, slow - Orange, medium - Red, fast

How to change the size of the tidal currents icon

1. Home page→[Settings]→[Chart Plotter].
2. Use the slider bar or software keyboard for [Tide/Current Icons Size] to set size (setting range: 50% to 150%)
3. Tap [x] on the title bar to finish and close the menu.

How to show the tidal currents information

Tap a tidal current icon to display the tidal currents information for the position selected. An example is shown right.



How to display the tidal current graph

Tap a tidal current icon to display the context-sensitive window. Tap [Graph] on the context-sensitive window to show the [Current] graph window

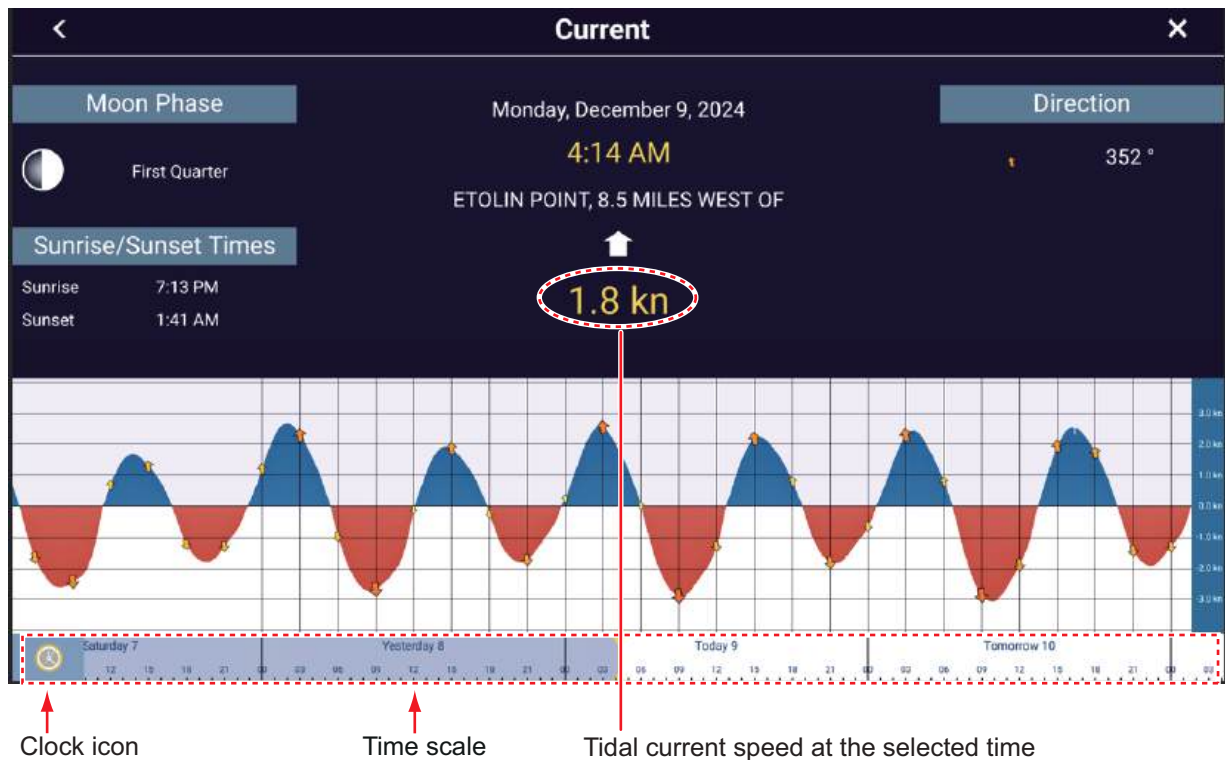

About the tidal current graph

Note: Forecasts are calculated based on mild weather conditions. Expected tidal times and tidal levels are dependent on the influence of storms and fronts.

- The vertical axis is the speed of the current; the horizontal axis is the time of the current.
- The information is mostly accurate under moderate weather conditions. However, storms and weather fronts can influence forecasted tidal current directions and speeds.
- To see tidal current speed at a selected time, drag the time scale at the bottom of the screen sideways then read the tidal current speed at the selected time. Drag to the left to display the future information, right for the past information.
- To set the time scale to the current time, tap the clock icon at the bottom left-hand corner of the screen to show the clock mark in yellow-white.



Clock icon for the current time



Clock icon other than the current time

- To return to the chart plotter display, tap [×] on title bar.

3.2.7 How to show the ACCU-FISH icon on the overlay

The ACCU-FISH icon (see section 6.15), can be shown on the chart plotter display with one of the following devices.

- DFF series or BBDS1 connected to an ACCU-FISH™ compatible transducer.

To show the ACCU-FISH icon on the chart plotter display, Layers menu→[Overlays] tab→turn on [ACCU-FISH]. Set to off to remove the icon from the chart plotter display.

Note: Control of the ACCU-FISH icon on the chart plotter display can always be done through the Layers menu, regardless of the [ACCU-FISH] setting (see section 6.15.3) on the [Fish Finder] menu.

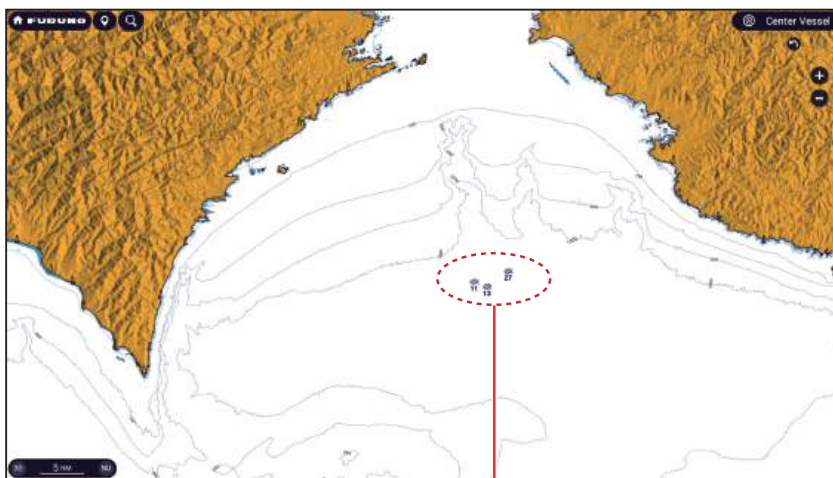

ACCU-FISH icon

4. POINTS, BOUNDARIES

4.1 About Points & Event Marks

In navigation terminology, a point is any location you mark on the chart plotter, radar, fish finder or weather display. A point can be a fishing spot, reference point or other important location. You can use a point you have entered to set as a destination.

This unit has 30,000 points (including event marks and MOB marks) into which you can enter position information.

A point is used to mark a location. When you enter a point, it is put on the screen with the default point icon (see subsection 4.5.1), as shown in the figure below.

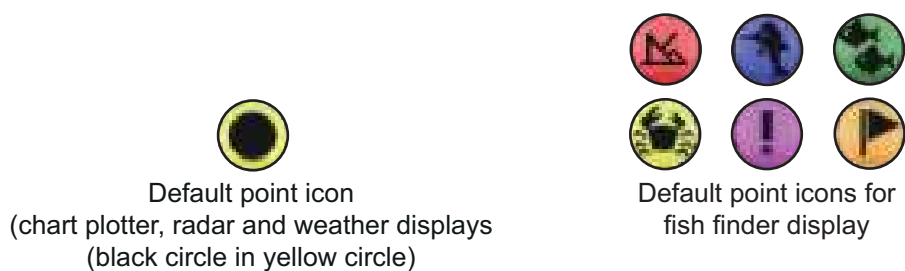

The event mark marks current position. Like with a point, you can use an event mark to set a destination.

The event mark is marked on the screen with the default event mark icon. See subsection 4.5.2.

A point or event mark is saved to the [Points] list with position, color, shape, etc. In the default setting, all points and event marks are shown on the display.

You can edit points and event marks on the screen and from the [Points] list.

Note 1: Event marks are handled the same as points.

Note 2: Points can be shared with other TZT9E/13E units via LAN. Data is shared automatically; no operation is required.



4.2 How to Enter Points, Event Marks

Note: Points, event marks, text size, etc. can be adjusted from the following menu. Home page→[Settings]→[General]→[This Display]→[Plotter Objects Size] (see section 16.1 for details).

4.2.1 How to enter points (chart plotter and radar displays only)

Method 1: Directly on-screen

1. Tap the position on the chart plotter display where to put a point.
2. Tap [New Point] on the Pop-up menu.

The point is put on the location selected in step 1 and is saved to the [Points] list. Registered points are automatically named "WP 001", "WP 002", etc. (the same number as the event mark). You can prevent automatic naming and change the "WP" name (see section 4.13).

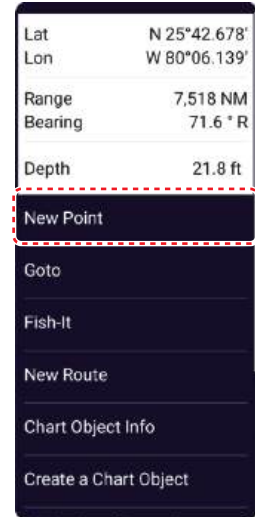

Pop-up menu for chart plotter display

Method 2: Manual input (chart plotter, radar, weather)

Open the Slide-out menu, then tap [Position Entry]. The position shown is the latitude/longitude of the center of the displayed area. Edit the position as required. Tap [Create] to register the point and close the keyboard.

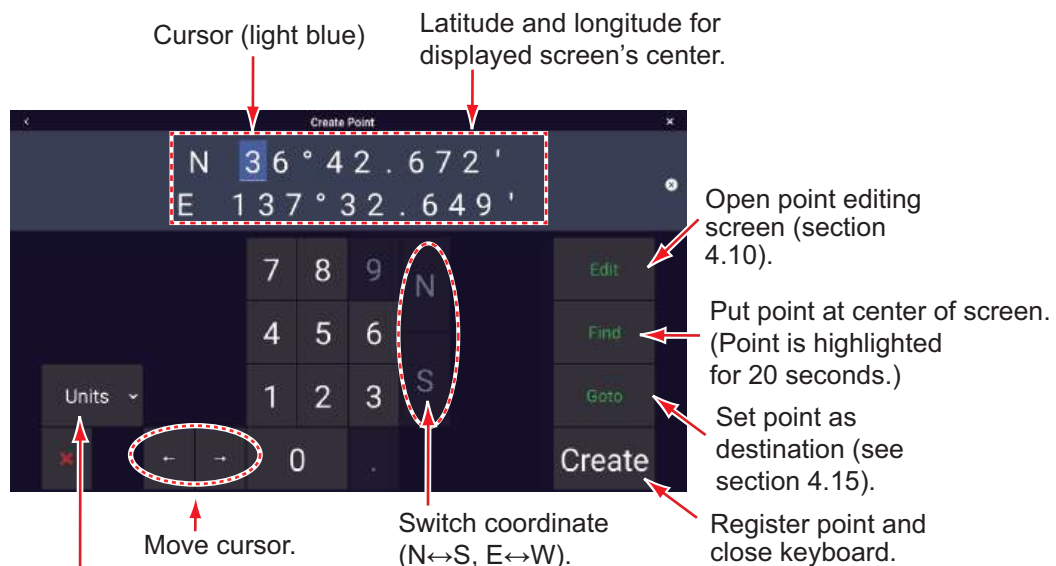

Position display format

Select position display format from pull-down menu.

Method 3: Register a point on the Points list

1. Home page→[Lists]→[Points].
2. Tap the [Add Point] button at top of the screen. The [Point] screen shows the latitude and longitude of the point to be registered and its location on the preview screen.
3. Edit the point referring to subsection 4.10.1.
4. Tap [x] on the title bar to finish and close the list.

Method 4: Input from external equipment (TZT9E/13E only)

External equipment (fish finder, etc.) can output points to this equipment. TLL data (NMEA 0183 format) from the external equipment is output to this equipment via an NMEA data converter (IF-NMEA2K2, option). The latitude and longitude position of the point is marked with the event icon.

4.2.2 How to enter event marks**Method 1: Event icon (long) tap**

At the top left corner, (long) tap the event icon to show the [Creating Events] window, shown below. Tap desired event mark.

Note: The (long) tap function of the event icon can be changed. See section 1.17.

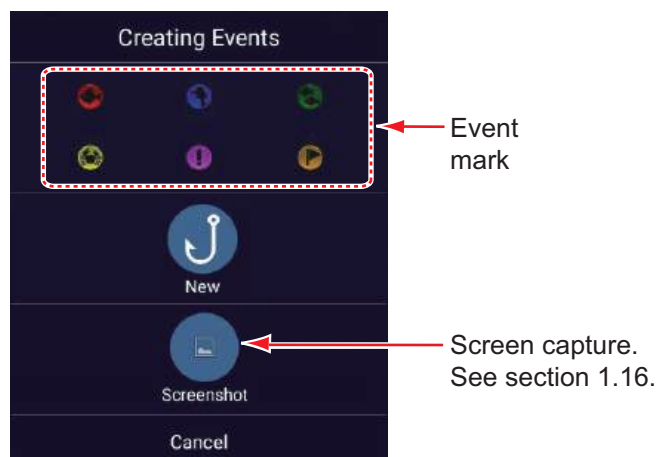
**Method 2: Two-finger (long) tap**

Home page→[Settings]→[General]→[This Display], then set [Two Finger Tap Function] (or [Two Finger Long Tap Function] for [Event Window], [Event Mark 1] or [Event Mark 2]). Tap (long tap) the screen with two fingers, then do as follows.

- **[Event Window]:** The [Creating Events] window appears. Select an event mark.
- **[Event Mark 1] or [Event Mark 2]:** Event mark 1 (or Event mark 2) appears at current position, in the pre-set symbol and color (section 4.5.2).

4. POINTS, BOUNDARIES

Log Catch

You can log the specifics of a catch (species, size, weight) together with an event mark, from the [Creating Events] window.

1. Open the [Creating Events] window, then tap [New].

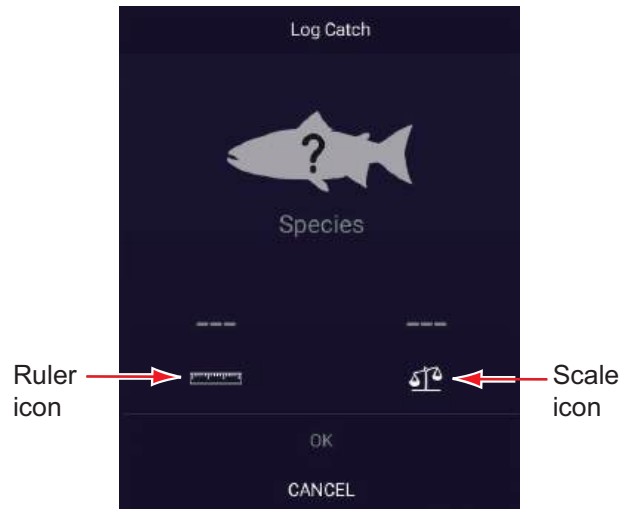

2. Tap [Species] to show the [Species] list. Tap applicable species in the list. A maximum of four species can be shown in the [Creating Events] window. When that amount is exceeded, the eldest species is deleted from the window.
3. Tap the Ruler icon to show the software keyboard. Enter length, then tap [✓] to confirm entry.
4. Tap the Scale icon to show the software keyboard. Enter weight, then tap [✓] to confirm entry.
5. Tap [OK] on the [Creating Events] window.

You can see the number of catches you have logged on the [DATA USAGE] section in the [General] menu. In the example below, 15 catches out of 1000 have been logged.

Points	15 / 30000
Routes	3 / 200
Areas & Lines	0 / 100
Circles	0 / 100
Photos	91 / 1000
Catches	15 / 1000
Track Points	228 / 100000

4.2.3 How to enter an event mark at a specific location

You can enter an event mark at a specific location on the fish finder display.

1. Tap the location on the fish finder display where to enter an event mark.
The Pop-up menu appears.

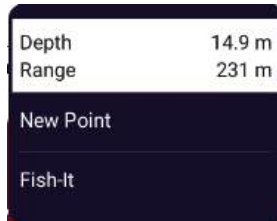

2. Tap [New Point] on the Pop-up menu.
The [Creating Events] window appears. See subsection 4.2.2.
3. Select an event mark.
The event mark is put at the location selected at step 1 and the point is saved to the [Points] list. The event mark appears on both the fish finder and chart plotter displays. However, the name of the event mark does not appear on the fish finder display.

4

4.3 How to Display Point, Event Mark, Catch Information

Tap a point, event mark, or catch mark to display its basic information (latitude, longitude, range from own ship, bearing from own ship, depth (event mark only)).

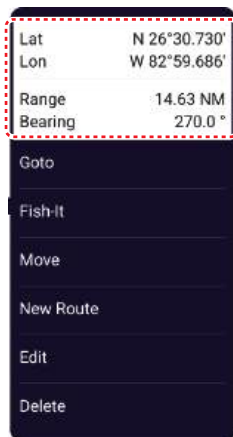

Point information

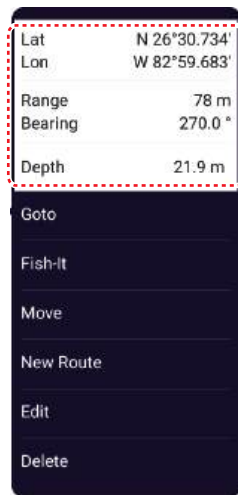

Event mark information

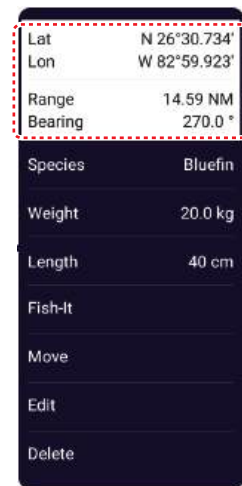

Catch information

4.4 How to Enter a Comment for an Event Mark

You can automatically attach a comment to an event mark. The comment is saved to the [Points] list, and the default comment is [None] (no comment). To apply a comment, do as follows:

1. Home page→[Settings]→[Points & Boundaries]→[Events]→[Data to Be Recorded in Event Comment].
2. Tap an option.
[None]: No comment
[Date]: Date
[SST]: Sea surface temperature
[Date and SST]: Date and sea surface temperature
3. Tap [×] on the title bar to finish and close the menu.

4.5 Default Point, Event Mark Settings

4.5.1 Default point settings

The equipment saves a point in the shape, color and size assigned in the [Points & Boundaries] menu. If the default point settings are not to your liking, change them as shown in the procedure below.

1. Home page→[Settings]→[Points & Boundaries]→[Points].
You can also show this menu as follows: Layers menu→[User Objects] tab→tap the setting icon (⚙️) on the left side next to the [Points].



2. Tap [Default Point Symbol].

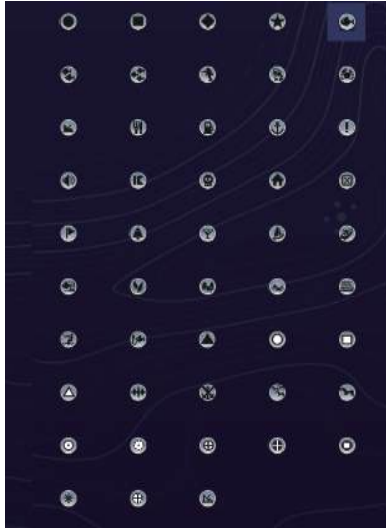

3. Tap required symbol, then tap [<] to go back one layer in the menu.
4. Tap [Default Point Color] to show the color options for points.



5. Tap required color, then tap [<] to go back one layer in the menu.
6. To change point size, use the slider bar or software keyboard for [Point Size].



7. Tap [Icons Set] to select the icons set to use.

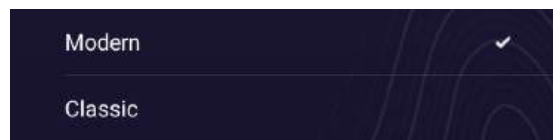

8. Select [Modern] or [Classic], referring to the figure below.



[Modern] point



[Classic] point

9. Tap [x] on the title bar to finish and close the menu.

4.5.2 Default event mark settings

1. Home page→[Settings]→[Points & Boundaries]→[Events].
2. Tap [Default Event Mark 1 Symbol].



3. Tap required symbol, then tap [<] to go back one layer in the menu.
4. Tap [Default Event Mark 1 Color] to show the color options for points.



5. Tap required color, then tap [<] to go back one layer in the menu.
6. Process Event Mark 2 - Event Mark 6 similar to how you processed Event Mark 1.
7. Tap [x] on the title bar to finish and close the menu.

4.6 How to Find Number of Points Used

Home page→[Settings]→[General]→[Data Usage]. In the example below, 12 out of 30,000 points have been used.

A screenshot of the 'Data Usage' settings page. The 'Points' row is circled with a red dashed line. The table shows the following data:

Points	12 / 30000
Routes	5 / 200
Areas & Lines	5 / 100
Circles	4 / 100
Photos	62 / 1000
Catches	4 / 1000
Track Points	65 / 100000

4.7 Points List

All points are stored in the [Points] list. The following point data is saved for each point.

- Name
- Position (latitude/longitude)
- Color
- Icon
- Comment
- Distance from own ship

4.7.1 How to show the Points list, process points

1. Home page→[Lists]→[Points].

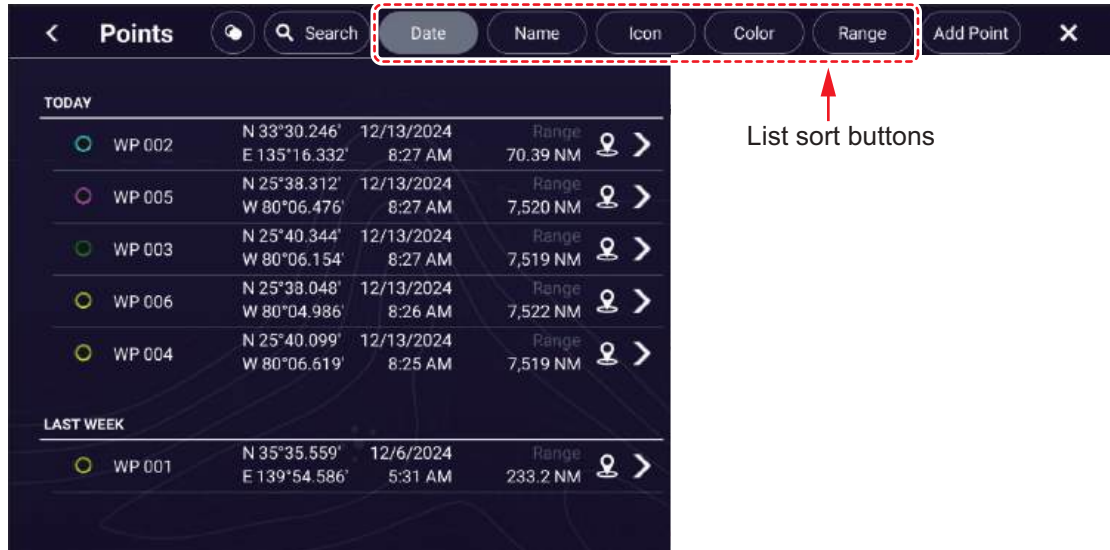

Tap  icon to show the preview display on the right-hand side for the selected point.

2. Tap the appropriate sort button at the top of the list.

How to sort points

The [Points] list can be sorted by the following methods:

[Date] Sort by date registered, in oldest-to-newest order.

[Name]: Sort by point name, in alphabet order.

[Icon]: Sort by icon shape.

[Color]: Sort by color.

[Range]: Sort by range from own ship, from nearest to farthest.

4. POINTS, BOUNDARIES

How to search points

Points can be searched by name, alphabet, icon, color

Search by name

- 1) Tap the magnifying glass icon on the [Points] list to show the software keyboard.

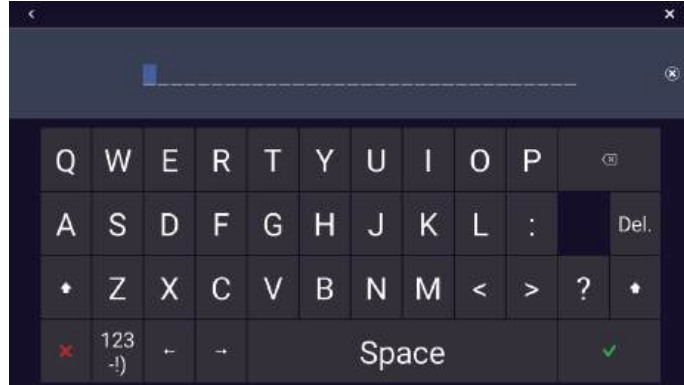

- 2) Enter a search string (full name, 2 - 3 characters), then tap [✓].

The [Points] list shows the matches found.

Search by alphabet

- 1) Tap [Name] if it is not already selected.
- 2) Tap any alphabet on the list.

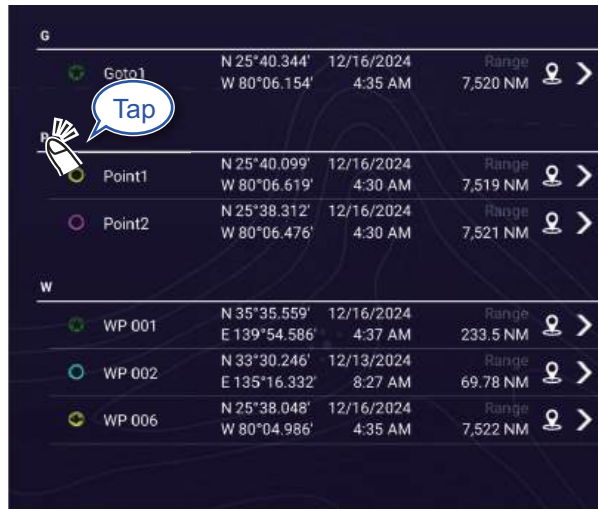

A search keyboard appears, with the alphabet search-able alphabet(s) colored blue.



- 3) Tap the alphabet to search.

Search by icon or color

- 1) Tap the [Icon] (or [Color]) button if it is not already selected.
- 2) Tap icon (or color).

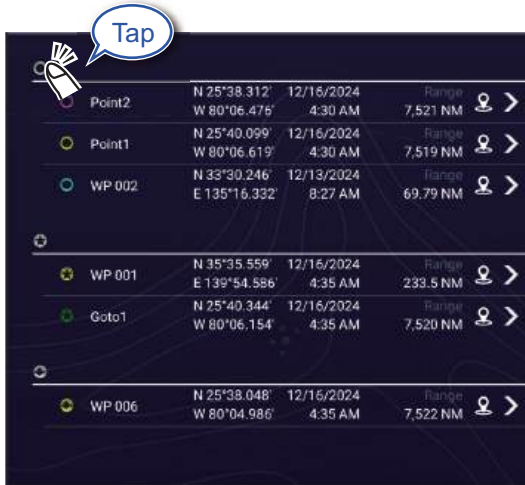

Search by icon

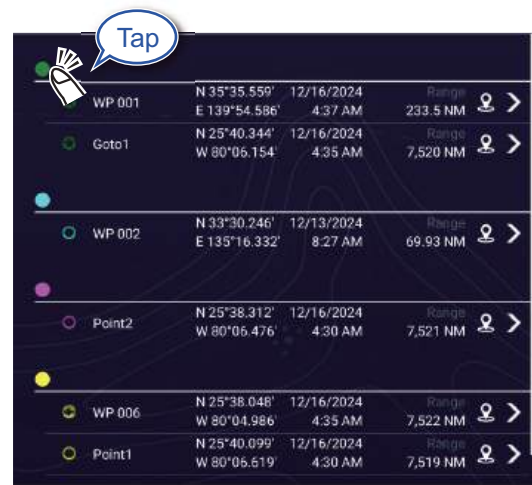

Search by color

Respective search display appears.

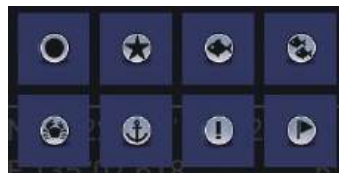

Search by icon

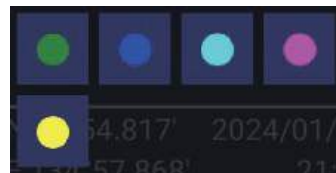

Search by color

- 3) Tap the icon (or color) to search.
The [Points] list shows the tapped icon (or color).
3. Tap the point to confirm or edit to show the Edit screen.

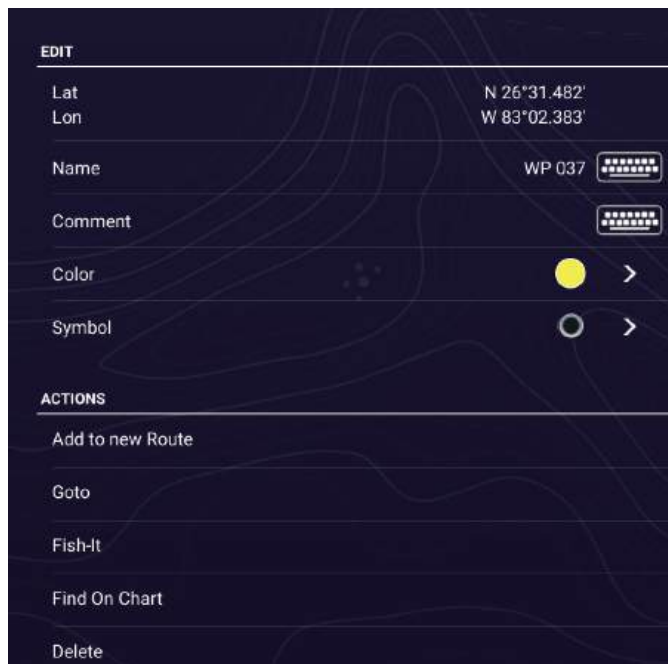

4. Tap the item (name, comment, color, icon) to edit. See section 4.10 for how to edit points.
5. Tap [x] on the title bar to finish and close the menu.

4. POINTS, BOUNDARIES

Catches list

Like with points, catch log symbols are stored in a list. Home page→[Lists]→[Catches]. For how to sort*, search, edit and delete catch log data, see the applicable procedure in the points section.

* The order of the date sort is newest date created.

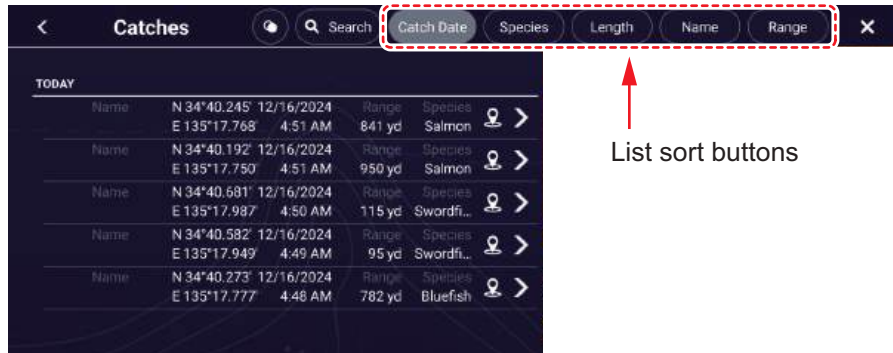

List sort buttons

4.8 How to Move Points

You can move a point by two methods, on the screen and from the [Points] list.

4.8.1 How to move on-screen points

1. Tap the point to move, then select [Move] from the Pop-up menu. The icon shown right is put on the point.
2. Drag and drop the point to its new location.
3. Tap [End Move] at the top right-hand corner of the screen to finish.



Note: A point can be moved to the position you specify. Tap the point and [Edit], then enter the latitude and longitude position from the software keyboard.

4.8.2 How to move points using the Pop-up menu

1. Tap the point to move to show the Pop-up menu. See section 4.3.
2. Tap the latitude and longitude information at the top of the window to show the software keyboard.
3. Change the latitude and longitude as necessary, then tap [✓]. The point is then centered on the screen.

4.8.3 How to move points from the Points list

1. Home page→[Lists]→[Points].
2. Tap the point to move to show the editing window.
You can also edit the position of a point from the screen. Tap the point then tap [Edit] on the Pop-up menu.
3. Tap [Lat Lon] to display the numeric keyboard.
4. Enter the position, then tap [✓] to confirm.
5. Tap [x] on the title bar to finish and close the menu.
The point is moved to the center of the screen.

4.9 How to Delete Points

You can delete points by two methods, on the screen and from the [Points] list

Note: The point currently set as a Goto point cannot be deleted.

4.9.1 How to delete on-screen points

Tap the point to delete, then tap [Delete] on the Pop-up menu.

4.9.2 How to delete points from the Points list

1. Home page→[Lists]→[Points].
2. Tap the point to delete, then tap [Delete]. The point disappears from both the screen and the [Points] list.
3. Tap [x] on the title bar to finish and close the menu.

4.9.3 How to delete points collectively from the Points list

The  icon in the title bar on the [Points] list allows you to edit and delete points collectively.

1. Home page→[Lists]→[Points].
2. At the top of the [Points] list, choose how to sort the points.
3. Tap the  icon. In the example list below the points are sorted by name.

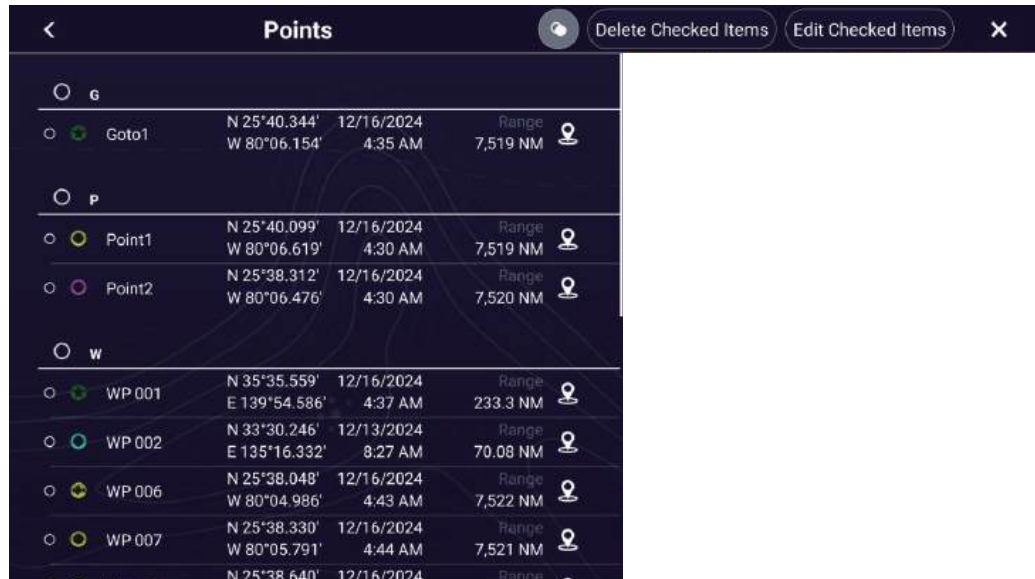

4. Tap the hollow circle to the left of the point(s) to delete to fill the circle in white, or tap an alphabet to delete all points that begin with that alphabet. For example, in the [Points] list above, tap the “W” to delete all photos whose name begins with “W”.
5. On the title bar, tap [Delete Checked Items]. A message asks if you are sure to delete the selected points. Tap [OK] to delete the points.

Like with points you can delete log catches from the [Catches] list.

4.9.4 How to delete all points from the menu

You can delete all points and routes except for the points included in the active route.

1. Home page→[Settings]→[Points & Boundaries]→[Delete All User Objects].
The message "Are you sure you want to delete all your user objects (marks, routes, boundaries) from this device and all other networked devices? If the cloud synchronization is enabled, this will also remove all user objects from any devices connected with the same TIMEZERO account. This action cannot be undone." appears.
2. Tap [OK].
Note: The "Cancel" icon does not appear when deleting all points.
3. Tap [x] on the title bar to finish and close the menu.

4.10 How to Edit Points

Registered points can be edited on-screen and from the [Points] list.

4.10.1 How to edit on-screen points

1. On the chart plotter display, tap the point to edit, then tap [Edit] on the Pop-up menu.

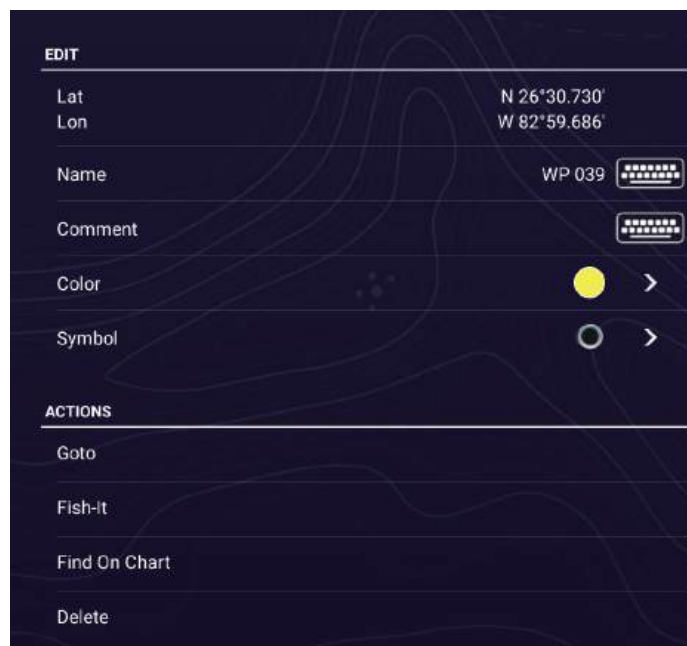

2. **To change position**, tap [Lat Lon] to show the software keyboard.



Units: Open the pull-down menu to change the position display format.

- 1) Tap numeric keys to enter position; tap the alphabet (N, S, E, W) to switch coordinates.
 - 2) Use the software keyboard to edit the position.
 - 3) Repeat steps 1) - 2) to change the position.
 - 4) Tap [✓] to finish.
3. **To change point name**, tap [Name] to show the software keyboard. See section 1.15.
 - 1) On the point name field, tap the alphanumeric character to change.
 - 2) Use the software keyboard to enter alphanumeric character.
 - 3) Repeat steps 1) - 2) to change other characters in the name.
 - 4) Tap [✓] to finish.
 4. **To change point comment**, tap [Comment] to show the software keyboard. After changing the comment, tap [✓] to finish.
 5. **To change point color**, tap [Color]. Tap desired color, then tap [<] on the title bar to go back one Layers menu.
 6. **To change point icon**, tap [Symbol]. Tap desired symbol, then tap [<] on the title bar to go to the previous menu.
 7. Tap [x] on the title bar to finish and close the menu.

4.10.2 How to edit points from the Points list

1. Home page→[Lists]→[Points].
2. Tap the point to edit.
3. Do steps 2 - 6 in section 4.10.1 to edit the point.
4. Tap [x] on the title bar to finish and close the menu.

4.10.3 How to edit points collectively from the Points list

The  icon in the title bar on the [Points] list allows you to edit points collectively.

1. Home page→[Lists]→[Points].
2. At the top of the [Points] list, choose how to sort the points.
3. Tap the  icon. In the example list below the points are sorted by name.

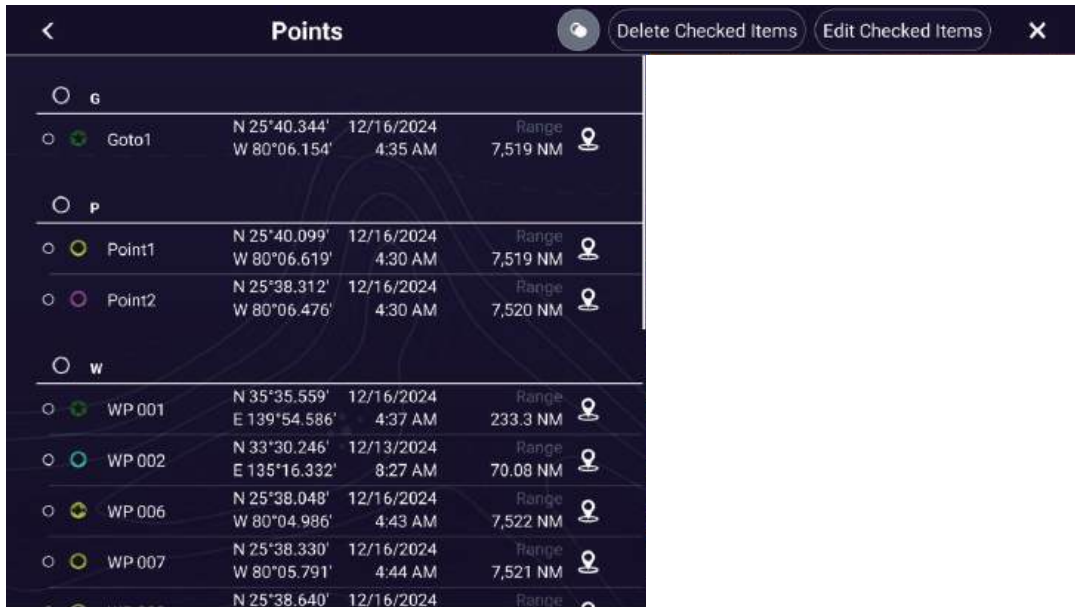

4. Tap the hollow circle to the left of the point to edit to fill the circle in white, or tap an alphabet to edit all points that begin with that alphabet. For example, in the [Points] list above, tap “W” to edit the point names beginning with W.
5. On the title bar, tap [Edit Checked Items].



6. To edit the name, comment, color, or icon, tap the item to edit and refer to the procedure in section 4.10.1.
 7. Tap [Save & Close] to save your changes and close the list.
- Like with points you can edit log catches from the [Catches] list.

4.11 How to Move a Point to the Screen Center

You can easily place a point at the center of the chart plotter display from the [Points] list.

1. Home page→[Lists]→ [Points].
2. Use the sort list buttons at the top of the list to sort the list.
3. Tap the point to move to the screen center.
4. Tap [Find On Chart].

The menu closes, the selected point is put at the center of the screen on the chart plotter display, and is highlighted for seven seconds.

Note: If a split screen is in use when this procedure is initiated, the split screen is replaced with the full screen chart plotter display, then the point is put at the center of the full screen display.

4.12 How to Show or Hide All Points, Points Names

4

Points

Layers menu→[User Objects] tab→turn [Points] on or off.

Points names

Home page→[Settings]→[Points & Boundaries]→[Points]→turn [Display Points Names] on or off.

This menu can also be accessed by opening the Layers menu and tapping the setting icon () to the left of [Points] on the [User Objects] tab.

4.13 How to Set Point Naming Functions

In the default setup, a point or event mark is automatically assigned the name “WPXXX” (XXX=three-digit number, sequential order, starting with 001). If you do not need automatic numbering or you want to change the prefix “WP” to something else, follow the procedure below.

1. Home page→[Settings]→[Points & Boundaries]→[Points].
This menu can also be accessed by opening the Layers menu and tapping the setting icon () left side of [Points] on the [User Objects] tab.
2. Turn [Automatic Naming] on (automatic naming enabled) or off (automatic naming disabled) as required.
3. To change the name prefix, tap [Automatic Naming Prefix] to show the software keyboard.
4. Enter desired name prefix, then tap [✓]
5. Tap [×] on the title bar to finish and close the menu.

4.14 How to Set Point Density

The screen can become cluttered if all points are shown. To prevent this, set point density as shown below to limit the number of points to show.

1. Home page→[Settings]→[Points & Boundaries]→[Points]→[Point Density] to show the following options.

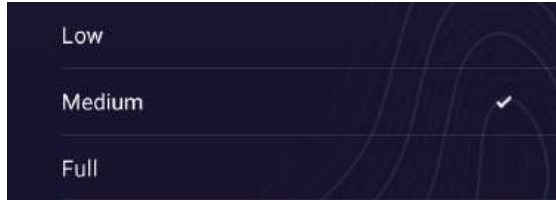



2. Tap desired point density. [Low] is the lowest point density, and [Full] displays all points.
3. Tap [×] on the title bar to finish and close the menu.

4.15 How to Set Point Filters

You can show/hide points on the screen using the filter function.

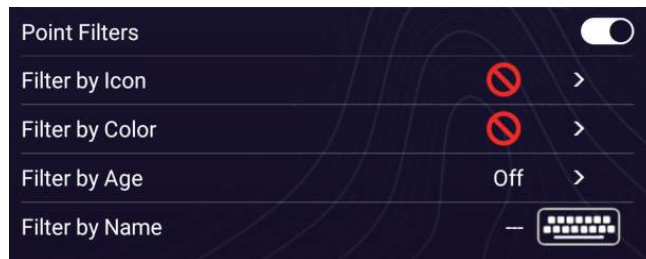
1. Open the Layers menu on the chart plotter, radar, or weather display→[User Objects] tab→[Points Filters].



2. Set the filter by icon, color, age, or name.
 - [Filter by Icon]: The list of icons is displayed. Select the icon for the point you want to display, then tap [×] at the top right-hand corner of the title bar to close the window. If you select , no filter is set for the icon.
 - [Filter by Color]: The list of colors is displayed. Select the color of the point you want to display, then tap the [×] at the top right-hand corner of the title bar to close the window. If you select , no filter is set for the color.
 - [Filter by Age]: The list of registration dates is displayed. Select the date for the point you want to display, then tap [×] at the top right-hand corner of the title bar to close the window. If you select [Off] no filter is set for the date.
 - [Filter by Name]: The software keyboard is displayed. Enter the name for the point you want to display, then tap the check mark (✓).

4.16 How to Go to a Point

Tap the point (including MOB mark) to go to among the three methods shown below.

- Select the point on the screen
- Select a position on the screen
- Select the point from the [Points] list

After you have selected a point, you can do the following.

- Restart the cross-track error (XTE) indication.
- Stop and restart Goto. (Tap the vessel icon to display the Pop-up menu. Tap [Stop Nav] and [Restart Nav] respectively.)
- Set how the autopilot behaves when you reach your destination (requires connection to a NAVpilot series autopilot).

Note: Before you try to go to a point, make sure that the path to the point is clear. Make sure to zoom your chart to check for hazards that appear on a smaller scale.

4.16.1 How to go to an on-screen point

1. Tap the desired point to show the Pop-up menu.
2. Tap [Goto].

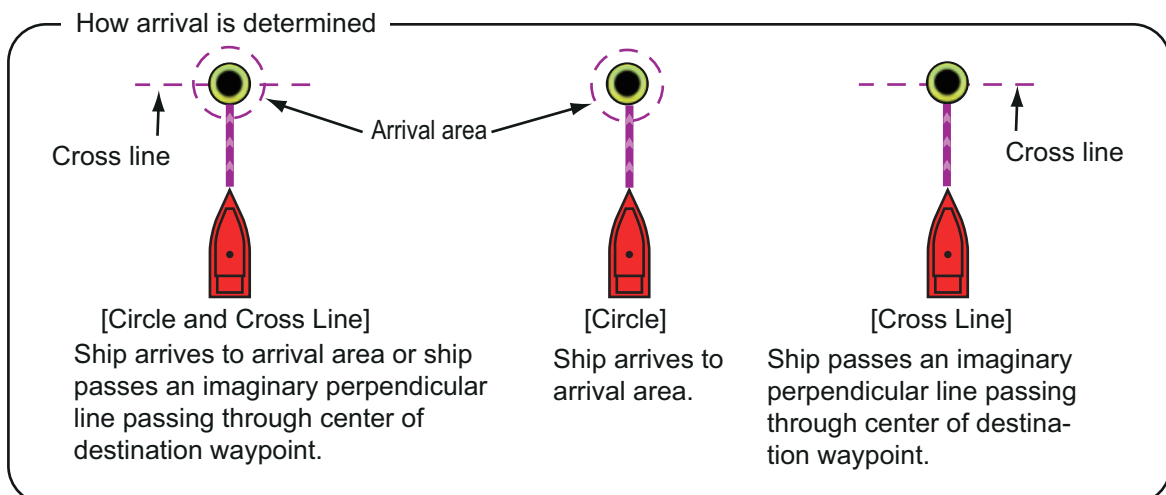
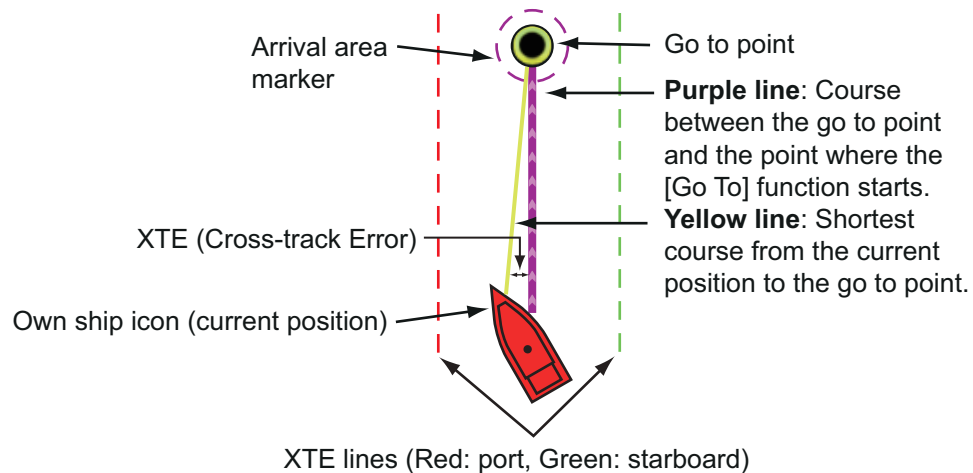

4. POINTS, BOUNDARIES

The following occurs:

- The Goto point is highlighted.
- A purple line and a yellow line extend from the vessel icon. The purple line is the course to follow to get to the point. The yellow line is the shortest course from the current position to the Goto point.
- The Navigation bar (provides destination information), or the Compass bar appears at the top of the display.

Navigation bar

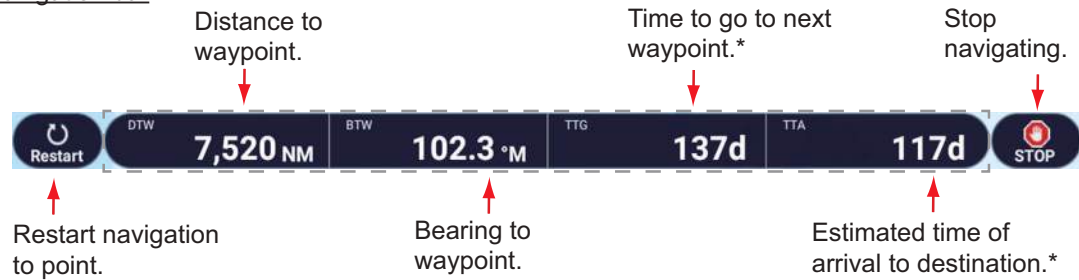

*: Same value in point navigation.



Tap the grey area to switch between the Navigation bar and the Compass bar.

Compass bar

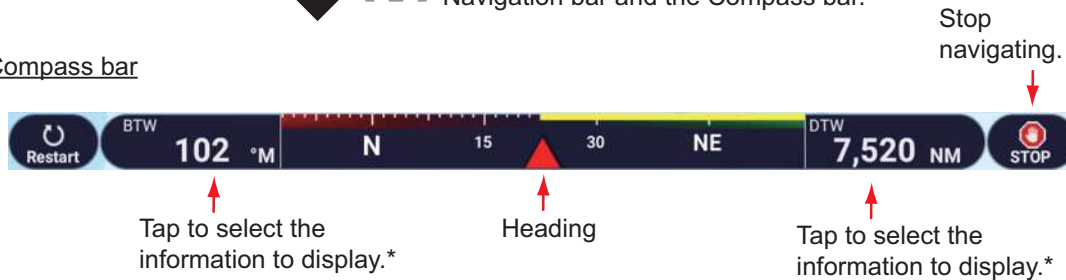

*: Display options

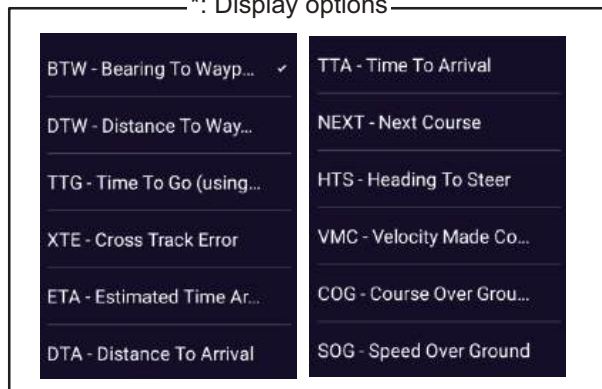

For how to use the [Restart] and [STOP] buttons, see section 4.17.

- Points are switch according the waypoint switching mode setting. To select the mode, Home page→[Settings]→[Routes]→[Routes]→[WPT Switch Mode]. Select [Circle and Cross Line], [Circle], or [Cross Line] as appropriate.
- The XTE lines, red for port side, green for starboard side, appear. You can show or hide these lines with [Cross Track Error Lines] in [Settings]→[Routes]→[Route Settings].

Note: If you want to be notified when you reach the Goto point (the end of a route), turn on [End of Route Notification] in [Routes]→[Route Settings] (see subsection 5.11.9). The message "End of Route" appears when you reach the end of a route. For the arrival timing, see subsection 5.11.5.

4.16.2 How to go to a position selected on screen

You can set a position as a point to go to without saving the point. The point is erased when the navigation is canceled or the power is turned off.

1. Tap the position to set as the Goto point to show the Pop-up menu.
2. Tap [Goto].

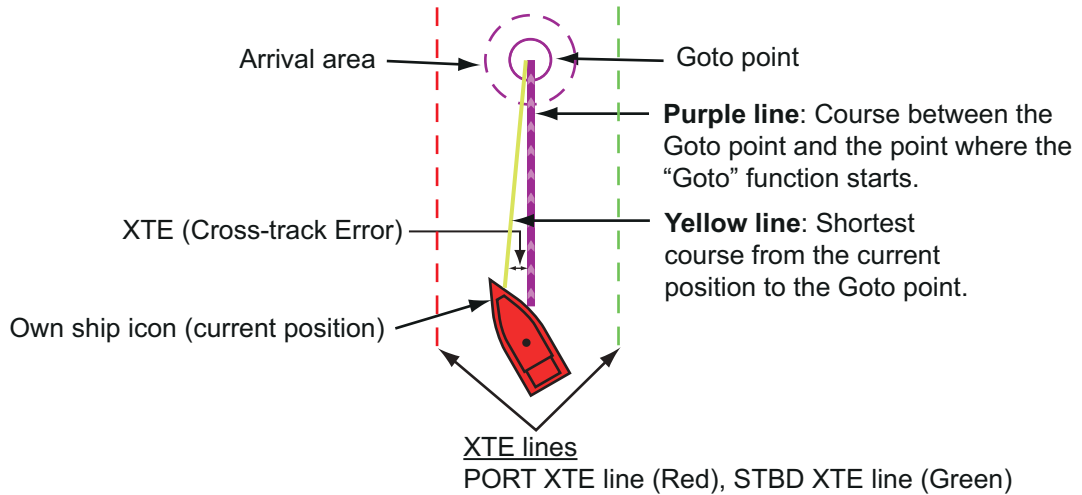

The following occurs:

- The Goto point is highlighted.
- A purple line and a yellow line appear on the vessel icon. The purple line is the course to follow to get to the point. The yellow line is the shortest course from the current position to the Goto point.

4. POINTS, BOUNDARIES

- The Navigation bar (provides destination information) appears at the top of the display.

Navigation bar

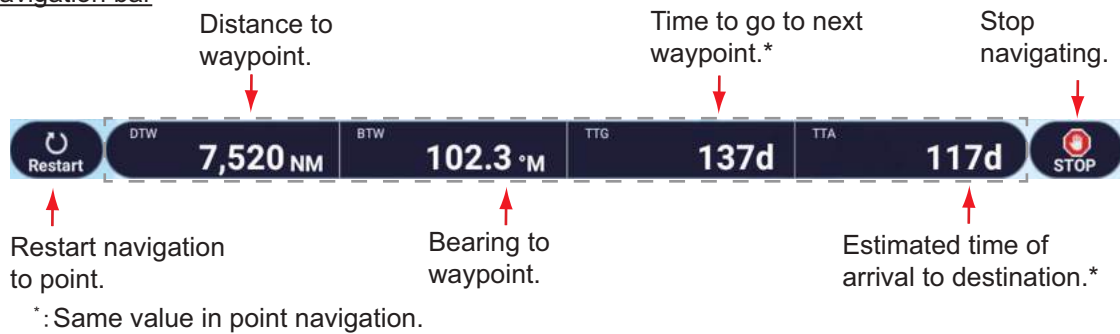

Tap the grey area to switch between the Navigation bar and the Compass bar.

Compass bar



*: Display options

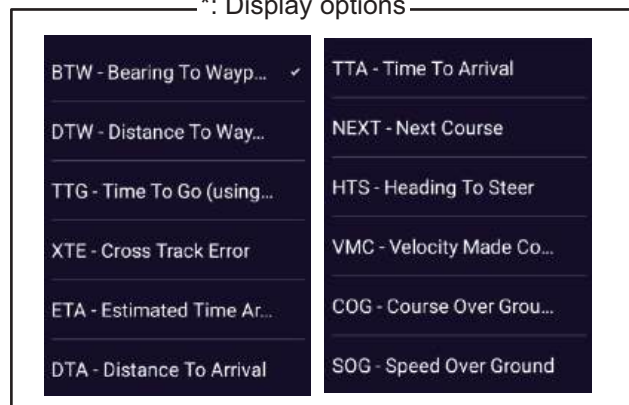

For how to use the [Restart] and [STOP] buttons, see section 4.17.

- Points are switch according the waypoint switching mode setting. To select the mode, Home page→[Settings]→[Routes]→[Routes]→[WPT Switch Mode]. Select [Circle and Cross Line], [Circle], or [Cross Line] as appropriate.
- The XTE lines, red for port side, green for starboard side, appear. You can show or hide these lines with [Cross Track Error Lines] in [Settings]→[Routes]→[Route Settings].

Note: If you want to be notified when you reach the Goto point (the end of a route), turn on [End of Route Notification] in the [Routes] menu (see subsection 5.11.9). Then the message "End of Route" appears when you reach the end of a route. For the arrival timing, see subsection 5.11.5.

4.16.3 How to go to a point selected from the Points list

1. Home page→[Lists]→[Points].
2. If you need to sort the list, use the list sort buttons at the top of the list.
3. Tap the point to set as the Goto point.
4. Tap [Goto].
5. Tap [x] on the title bar finish and close the list.

The following occurs:

- The Goto point is highlighted in the [Points] list.
- A purple line and a yellow line appear on the point. The purple line is the course to follow to get to the point. The yellow line is the shortest course from the current position to the Goto point.
- The Navigation bar (provides destination information) appears at the top of the display.

Navigation bar

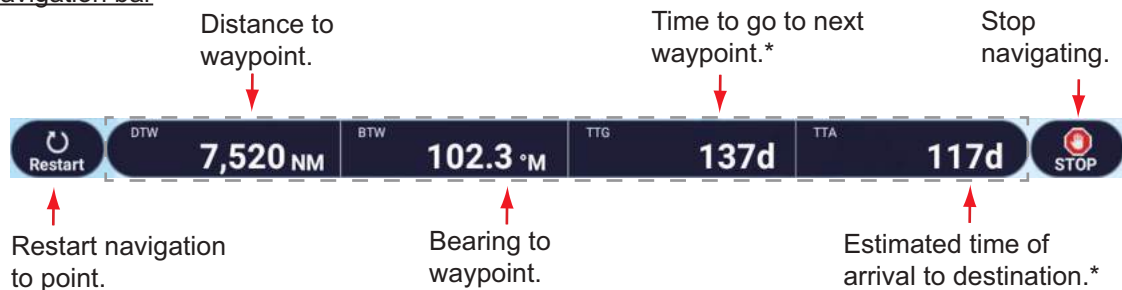

*: Same value in point navigation.



Tap the grey area to switch between the Navigation bar and the Compass bar.

Compass bar

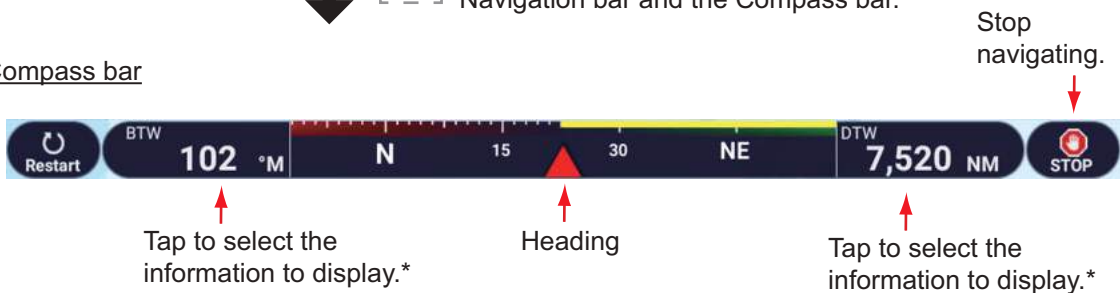

*: Display options

BTW - Bearing To Wayp... ✓	TTA - Time To Arrival
DTW - Distance To Way...	NEXT - Next Course
TTG - Time To Go (using...	HTS - Heading To Steer
XTE - Cross Track Error	VMC - Velocity Made Co...
ETA - Estimated Time Ar...	COG - Course Over Grou...
DTA - Distance To Arrival	SOG - Speed Over Ground

For how to use the [Restart] and [STOP] buttons, see section 4.17.

4. POINTS, BOUNDARIES

- The waypoint switching method can be selected from the menu. Home page→[Settings]→[Routes]→[Route Settings]→[WPT Switch Mode]. Select [Circle and Cross Line], [Circle] or [Cross Line].
- The XTE lines, red for port side, green for starboard side, appear. You can show or hide these lines with [Cross Track Error Lines] in [Routes]→[Route Settings].

Note: If you want to be notified when you reach the Goto point (the end of a route), turn on [End of Route Notification] in [Routes]→[Route Settings] (see subsection 5.11.9). Then the message "End of Route" appears when you reach the end of a route. For the arrival timing, see subsection 5.11.5.

4.16.4 How to use the NAVpilot to steer to a point

When the NAVpilot-700 is activated and you set a destination point, the message "DO YOU WANT TO NAVIGATE USING THE NAVPILOT?" appears. Tap [Yes] to have the NAVpilot steer the vessel, and the NAVpilot automatically goes into the NAV mode.

For the NAVpilot-300, NAVpilot-1000, you are asked to select a navigation mode. Select [NAVpilot Precision Mode], [NAVpilot Economy Mode], or [Hand Steer], (For [Hand Steer], the NAVpilot-300, NAVpilot-1000 stays in a standby state. After selecting a mode, the NAVpilot-300, NAVpilot-1000 automatically goes into the navigation mode.

NAVpilot precision mode: Keeps XTE within 0.01 NM

NAVpilot economy mode: Keeps XTE within 0.03 NM

The example figure below shows the NAVpilot's display in the NAV mode. See subsection 2.15.3 for details.

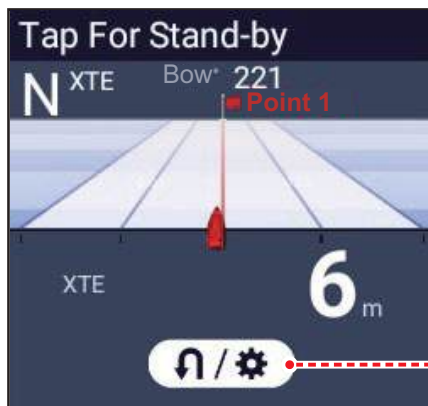

Turn/Setting
Appears when NAVpilot-300/1000
is engaged.

4.16.5 How to display the point information for the active Goto point

1. Tap the yellow line that runs between own ship and the Goto point to show the Pop-up menu. Note that the purple line can also be tapped to show the Pop-up menu.

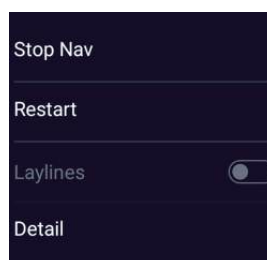

2. Tap [Detail] to show the [Route Detail] window.

Route Detail							>
ID	BTW	SPEED	DISTANCE	TOTAL	TTG	TOTAL	>
Start	—°	—kn	0 m	0 m	0'00s	0'00s	>
Goto	76.7°	10.0 kn	9.067 NM	9.067 NM	54'31s	54'31s	>

3. Tap [x] on the title bar to finish and close the menu.

Description of Route Detail window

Colored vertical bars: The bars at the left edge of the screen are colored according to the status of the Goto point.

Gray: Starting point

Yellow: Goto point

[ID]: Point no. ([Start] or [Goto]).

[BTW]: Bearing to Goto point.

[SPEED]: Speed to Goto point.

[DISTANCE]: Distance from starting point.

[TOTAL]: Total distance from start to Goto point.

[TTG]: Time to go to the Goto point, using speed shown in [SPEED] column.*

[TOTAL]: The time from start to the Goto point.*

* Calculated by the value in the [SPEED] column.

4

4.17 How to Restart or Cancel Navigation to a Point

4.17.1 How to restart navigation to a point

When you go to a point, you can restart the navigation to the point from the current location.

When you steer to keep away from an obstruction or the ship drifts, you go off course as shown in Line 1 in the figure. If you do not need to return to the original course, you can go to the point from the current position as shown in Line 2 in the figure.

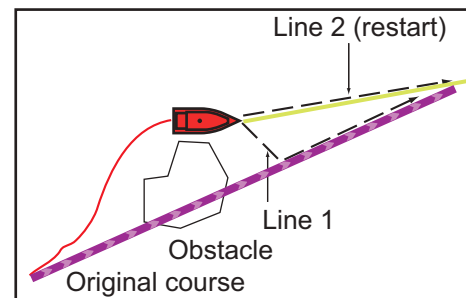

You can restart navigation by two methods:

From Navigation bar

Tap the [Restart] button on the Navigation bar.

From the Pop-up menu

1. Tap the purple line or the yellow line of the route to display the Pop-up menu.
2. Tap [Restart]. The route start position for the route moves to the current position.

4.17.2 How to cancel navigation to a point

From Navigation bar

Tap the [STOP] button on the Navigation bar.

From the Pop-up menu

1. Tap the purple line or the yellow line of the route to display the Pop-up menu.
2. Tap [Stop Nav]. The route start position for the route moves to the current position. The set course, yellow line, XTE lines, arrival area, and the Navigation bar are erased from the screen.

From the Slide-out menu

Open the Slide-out menu, then tap [Stop Nav]. The set course, solid yellow line, cross-track error line, arrival range, and destination information at the top of the screen disappear.

4.18 Boundaries

Boundaries can be marked anywhere on the chart plotter display, and can be used to denote net position, avoidance areas, etc. Boundaries can be shown or hidden and edited. Additionally, an audiovisual alarm can be set to alert when your vessel approaches a boundary.

Boundaries created with TIMEZERO Marine Software can be imported.

4.18.1 How to create boundaries

A boundary is available in three forms: area, circle, line. A boundary can be stored in the unit's database and shared on a "cloud" (internet connection required) and the local network.

Method 1: How to create a boundary on the screen

1. Tap the location on the chart plotter display where you want to place a boundary.
2. Tap [New Boundary] on the Pop-up menu.
3. Tap [Area], [Circle] or [Line] as appropriate. An icon corresponding to the boundary type selected appears at the location selected at step 1.
4. Do one of the following depending on the boundary type selected.

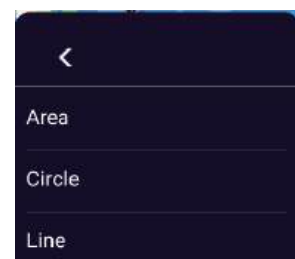

Area boundary

- 1) Tap the location for the next point of the area. A yellow line runs between the 1st location and the 2nd.
- 2) Tap the location for the next point of the area. Repeat this step to complete the area. You can drag an icon to change the position of a point.

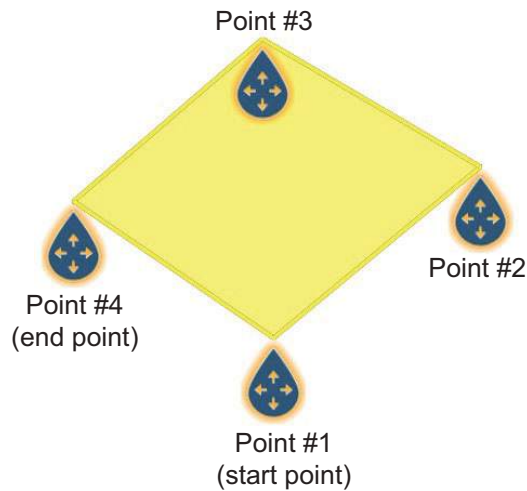

- 3) After selecting the end point, tap [End Boundary] at the top-right corner.

Circle boundary

- 1) Tap the location for the circle area. A yellow circle appears with circle resizing icons. Drag the icons to change the location and radius of the circle.

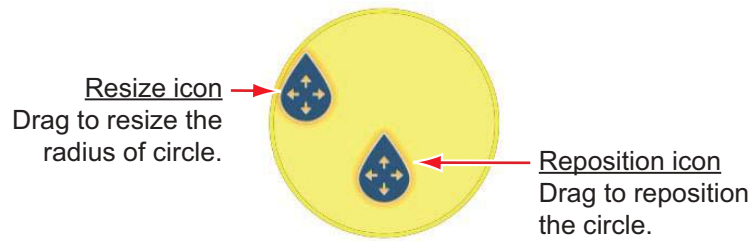

- 2) After arranging the circle, tap [End Boundary] at the top-right corner.

Line boundary

- 1) Tap the location for the next point of the area. A yellow line runs between the 1st location and the 2nd.
- 2) Tap the location for the next point of the area. Repeat this step to complete the area. You can drag an icon to change the position of a point.

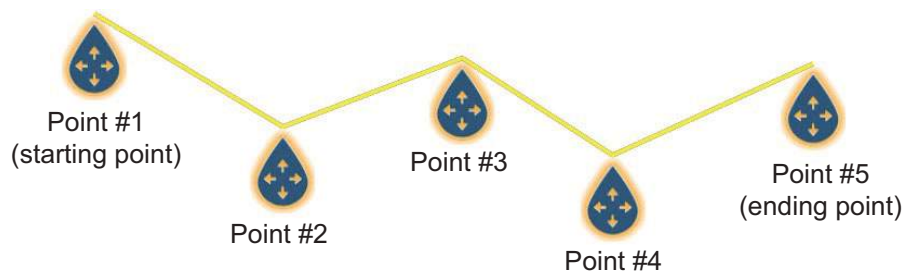

- 3) After selecting the ending point, tap [End Boundary] at the top-right corner. The boundary line is placed at the center of the screen.

Method 2: How to create an area or line boundary from the Boundaries list

1. Home page → [Lists] → [Boundaries].
2. At the top of the screen, tap [Add Area] or [Add Line] depending on the type of boundary you want to make.

4. POINTS, BOUNDARIES

3. Use the software keyboard to enter the latitude and longitude position of the starting point, then tap [✓].
The point is entered at center of the preview screen.
4. Tap [Add Point].
5. Enter the latitude and longitude position of the next point, then tap [✓].
Repeat this step to complete the boundary.
6. Tap [<] on the title bar to go back one layer in the menu.
7. Refer to section 4.18.5 to edit the boundary.
8. Tap [×] on the title bar to finish and close the menu.

4.18.2 How to show or hide all boundaries

On the Layers menu, tap the [User Objects] tab, then turn [Boundaries] on or off.

4.18.3 How to set default boundary attributes

You can set the color, line type and transparency of boundaries in the [Points & Boundaries] menu.

1. Home page→[Settings]→[Points & Boundaries]→[Boundaries].

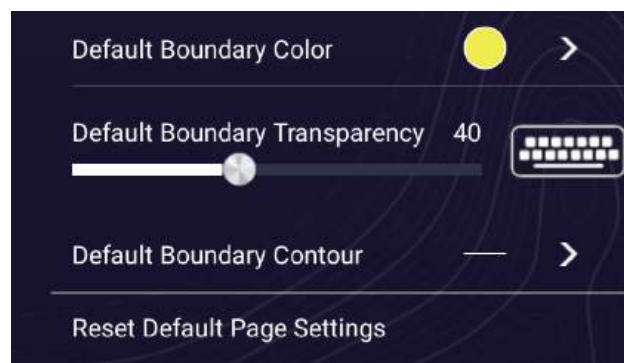

2. Tap [Default Boundary Color].



3. Tap the color desired, then tap [<] on the title bar to go back one layer in the menu.
4. To change boundary transparency, use the slider bar for [Default Boundary Transparency].
5. Tap [Default Boundary Contour].
6. Tap the line type desired.
7. Tap [×] on the title bar to finish and close the menu.



4.18.4 Boundaries list

Boundaries are stored on the [Boundaries] list. From the list you can find information about boundaries and edit boundaries. The following data is stored for each boundary created.

- Boundary name
- Boundary comment
- Boundary color
- Boundary line type
- Boundary transparency
- Alarm status
- Distance from own ship
- Boundary latitude and longitude position (circle only)
- Boundary area (circle only)

How to display the Boundaries list

1. Home page→[Lists]→[Boundaries].

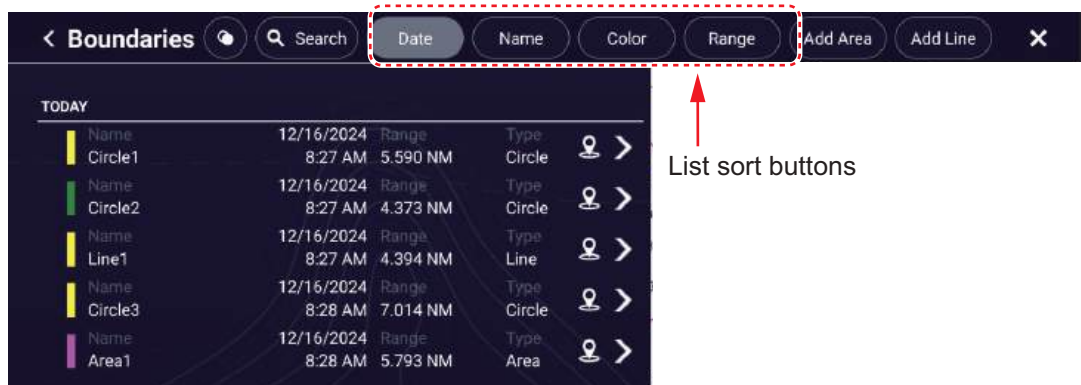

2. To sort the list, do as shown on the next page.

4. POINTS, BOUNDARIES

List sorting methods

[Date]: Sort by date

[Name]: Sort by name

[Color]: Sort by color

[Range]: Sort by range from own ship

How to search boundaries

Boundaries can be searched by entering name, alphabet and color.

Search by name

- 1) Tap the magnifying glass at the top of the screen.

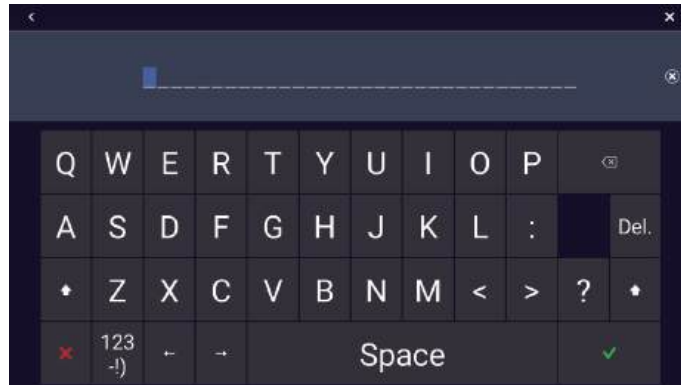

- 2) Enter the name (2-3 characters) of the boundary to search for, then tap [✓].
Boundaries matching the name entered appear in the list.

Search by alphabet

- 1) Tap [Name] at the top of the list.
- 2) Tap the alphabet to search.

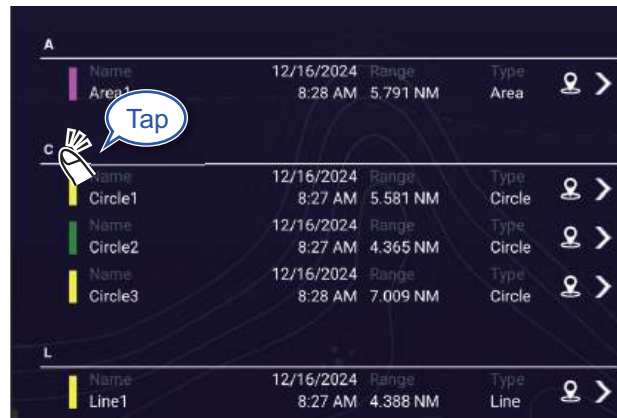

The alphabet search screen appears, showing, in blue, the alphabets available for search.



- 3) Tap the alphabet to search.

The list is sorted with the alphabet selected at the top of the screen.

Search by color

- 1) Tap [Color] at the top of the list.
- 2) Tap the color to search.

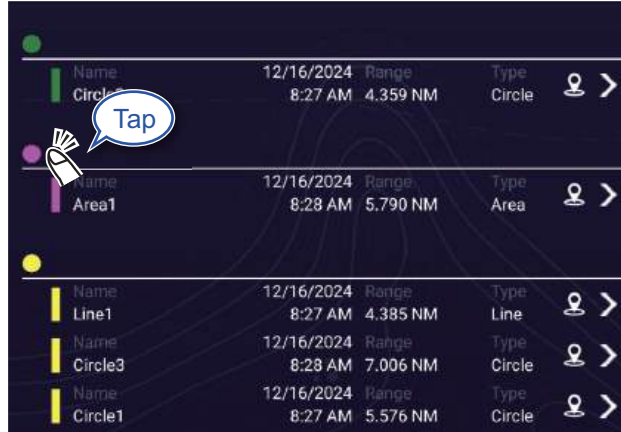

The color search screen appears, showing the colors available for search. The number of displayed colors depends on the number of used track colors. The alphabets under which boundaries are stored are shown in blue.

4

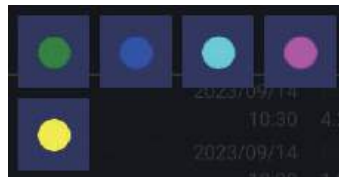

- 3) Tap the color to search.

The list is sorted with the color selected at the top of the screen.

3. To find information about a boundary or edit a boundary, tap the boundary entry in the list.

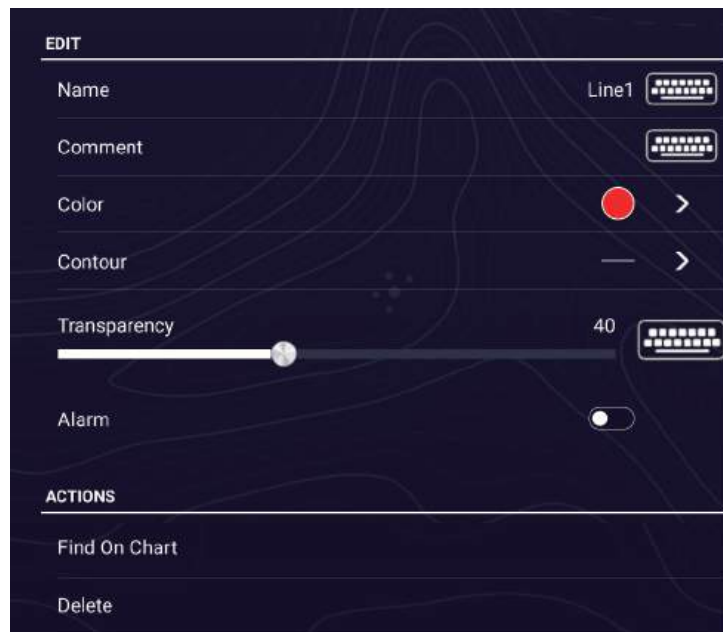

4. Tap respective item (Latitude, Longitude circle only), Radius (circle only), Name, Comment, Color, Contour, Transparency to change its data.
5. Tap [x] on the title bar to finish and close the menu.

4. POINTS, BOUNDARIES

4.18.5 How to edit boundaries

On-screen boundaries can be edited as shown in this section.

Note: The entire area boundary must be present on the display in order to display it. Zoom to fit the boundary within the screen.

How to edit a boundary on the screen

1. Tap the boundary to edit to show the Pop-up menu.

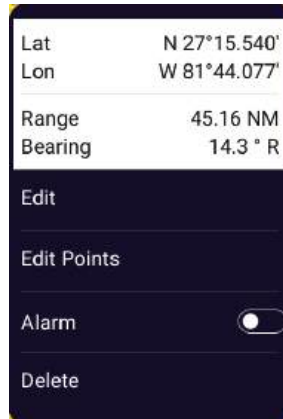

2. Tap [Edit] to show the Edit screen.

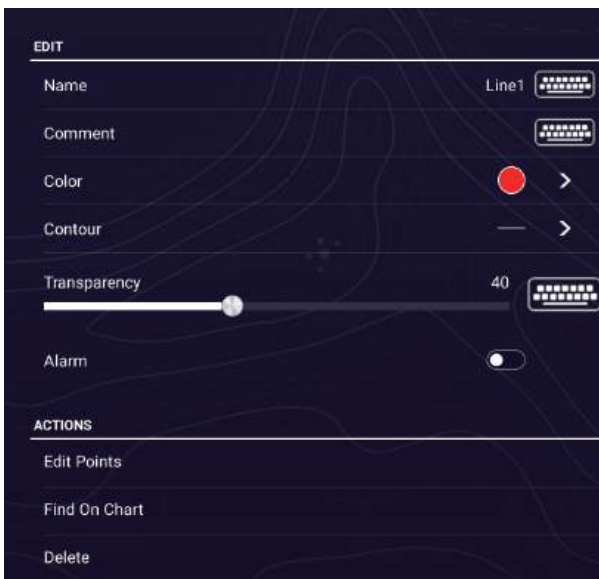

Edit screen for Area, Line boundary

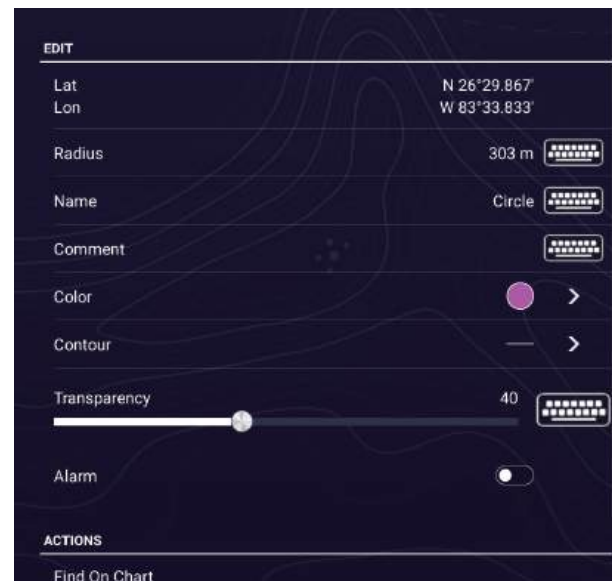

Edit screen for Circle boundary

Go to step 3 to edit a circle, or go to step 7 to edit a line or area.

3. To change circle position, tap [Lat Lon].
4. Use the software keyboard to enter new position, then tap [✓].
5. To change circle radius, tap [Radius].
6. Use the software keyboard to enter new radius, then tap [✓].
7. To change the name, tap [Name].
8. Enter new name, then tap [✓].
9. To change the comment, tap [Comment].
10. Enter new comment, then tap [✓].
11. To change the color, tap [Color].

12. Tap color desired, then tap [<] on the title bar to go back one layer in the menu.
13. To change line type, tap [Contour].
14. Tap line type desired, then tap [<] on the title bar to go back one layer in the menu.
15. To change boundary transparency, tap [Transparency].
16. Use the slider bar for [Transparency], or enter desired value with the software keyboard at [Transparency].
17. Tap [x] on the title bar to finish and close the menu.

How to edit boundaries collectively from the Boundaries list

The  icon in the title bar on the [Boundaries] list allows you to edit boundaries collectively.

1. Home page → [Lists] → [Boundaries].
2. At the top of the list, choose how to sort the boundaries, by [Date], [Name], [Color], [Range].
3. Tap the  icon. In the example list below the boundaries are sorted by name.

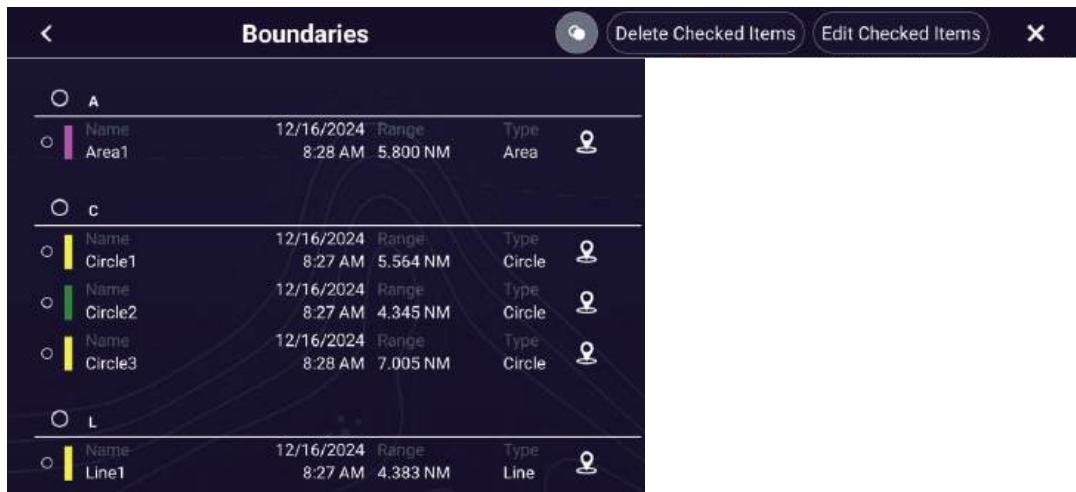

4. Tap the hollow circle to the left of the boundary to edit to fill the circle white, or tap an alphabet to edit all points that begin with that alphabet. For example, in the [Points] list above, tap "B" to edit the point names beginning with W.
5. On the title bar, tap [Edit Checked Items].



6. To edit the name, comment, color, or icon, tap the item to edit and then make changes as necessary.

4. POINTS, BOUNDARIES

7. Tap [Save & Close] to save changes and close the list.

4.18.6 How to add a point to a boundary

You can add points to a line or area type boundary.

1. Tap the boundary to which you want to add a point(s).
2. Tap [Edit Points] on the Pop-up menu. Icons appear on the boundary.
3. Tap the position where to add a point, and an icon appears at that position. If necessary, drag the icon to reposition the new point.
4. Tap [End Boundary] at the top-right corner to finish.

4.18.7 How to move a point on a boundary

You can move a point on a boundary by two methods, on-screen and on the [Boundaries] list.

How to move an on-screen point

1. Tap the boundary to which you want to add a point(s).
2. Tap [Edit Points] on the Pop-up menu.
Icons appear on the boundary.
3. **For area or line type boundary:** Drag the icon to new location.
For circle boundary: Drag the “resize” or “relocate” icon to new location.
4. Tap [End Boundary] at the top-right corner to finish.

How to move a point from the Edit screen

1. Tap the boundary to which you want to add a point(s).
2. Tap [Edit] on the Pop-up menu to show the Edit menu.
3. Tap [Edit Points] to show the [Boundary Detail] screen.
4. Tap the point whose position you want to change to show the [Position] screen.
5. Tap [Lat Lon] to show the software keyboard.
6. Use the software keyboard to enter new position, then tap [✓].
7. Tap [×] on the title bar to finish and close the menu.

4.18.8 How to delete a point from a line or area boundary

You can delete a point from a line or area boundary.

1. Tap the line or area boundary to process.
2. Tap [Edit Points] on the Pop-up menu.
Icons appear on the boundary.
3. Tap the icon belonging to the point to delete, then tap the [Delete] indication.
4. Tap [End Boundary] at the top-right corner to finish.

4.18.9 How to set an alarm for a boundary

How can get an audiovisual alarm when your vessel approaches a boundary within the specified distance.

1. [Alarms] menu→[Own Ship]→[Own Ship Alarm Zone]
2. Tap [Own Ship Alarm Zone] to show the software keyboard.
3. Enter the distance for the alarm, then tap [✓]. When your vessel is within this distance to the boundary, the audiovisual alarm is released.
4. Tap [×] on the title bar.
5. On the chart plotter display, tap the boundary for which you want to get the alarm, and a Pop-up menu appears.
6. Turn on [Alarm]. Note that the alarm for a boundary can be turned on/off from the Edit screen.

When your vessel is within the distance set at step 3, a black dashed line runs between the vessel icon and the boundary as shown in the figure below.

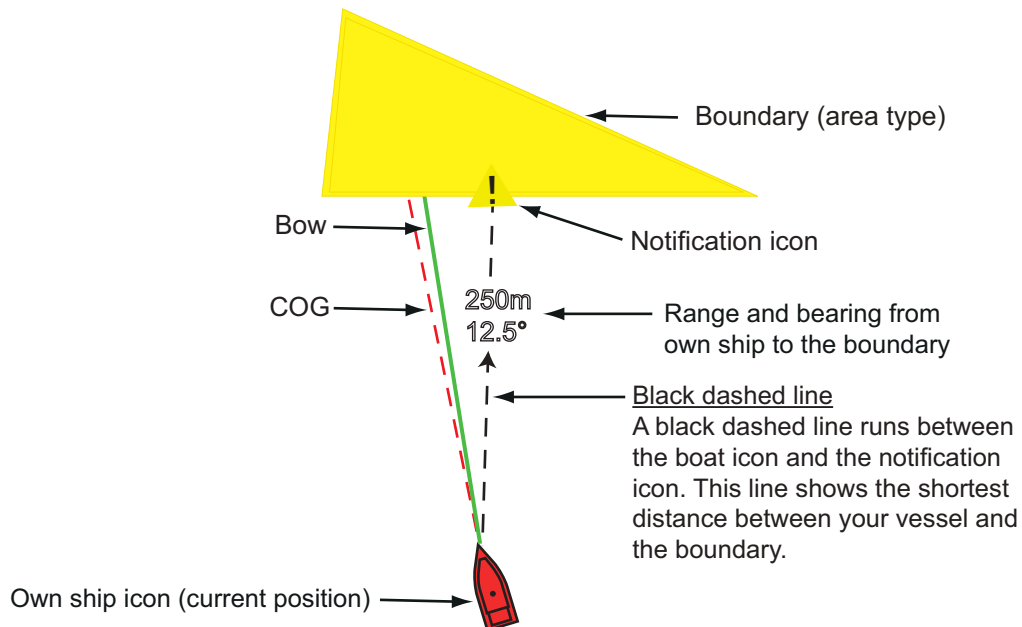

- The Status bar at the top of the screen shows the message “Near Alarm Zone: Area” (or Circle, or Line), and the audio alarm sounds. The audio alarm can be silenced by tapping the Status bar.
- The boundary is highlighted.
- A dashed black line runs between the vessel icon and the notification icon. This line shows the shortest distance between own ship and the boundary.
- The range and bearing to the boundary are overlaid on the black line.
- If the Data window has the item [Boundary Alarm Zone], the distance to the boundary appears in the Data window, like the example shown below.

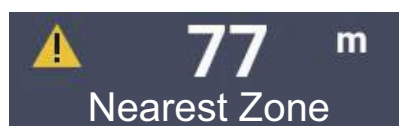

In the case of areas and circles, when the ship enters the boundary, the boundary turns red and flashes. Also, in the Status bar, the message “In Alarm Zone: Area” (or Circle) appears and the audible alarm sounds.

4. POINTS, BOUNDARIES

In the case of a line, when your ship crosses the line, in addition to the notification message, the Status bar shows the message "Boundary Line Crossed" appears in the Status bar and the audible alarm sounds.

4.18.10 How to find the number of boundary points used

Home page→[Settings]→[General]→[Data Usage]. In the example below, five [Areas & Lines] and four [Circles] have been used.

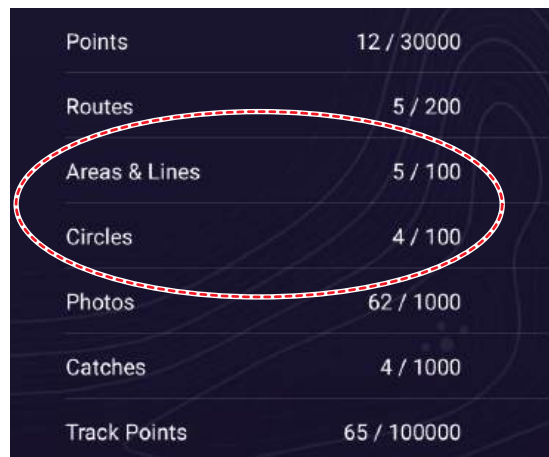

Points	12 / 30000
Routes	5 / 200
Areas & Lines	5 / 100
Circles	4 / 100
Photos	62 / 1000
Catches	4 / 1000
Track Points	65 / 100000

4.18.11 How to display a boundary at the screen center

Do the following to move a boundary to the screen center.

1. Home page→[Lists]→[Boundaries].
2. Tap the boundary that you want to place at the screen center.
3. Tap [Find on Chart].

The chart plotter display appears, with the selected boundary at the screen center.

4.18.12 How to delete boundaries

How to delete an on-screen boundary

Tap a boundary line to show the Pop-up menu. Tap [Delete] to delete the line from the screen.

How to delete a boundary via the Boundaries list

1. Home page→[Lists]→[Boundaries].
2. Tap the boundary to delete, then tap [Delete]
3. Tap [x] on the title bar to finish and close the menu.

How to delete boundaries collectively via the Boundaries list

The  icon in the title bar on the [Boundaries] list allows you to delete boundaries collectively.

1. Home page→[Lists]→[Boundaries].
2. At the top of the [Boundaries] list, choose how to sort the boundaries.
3. Tap the  icon. In the example list below the boundaries are sorted by name.

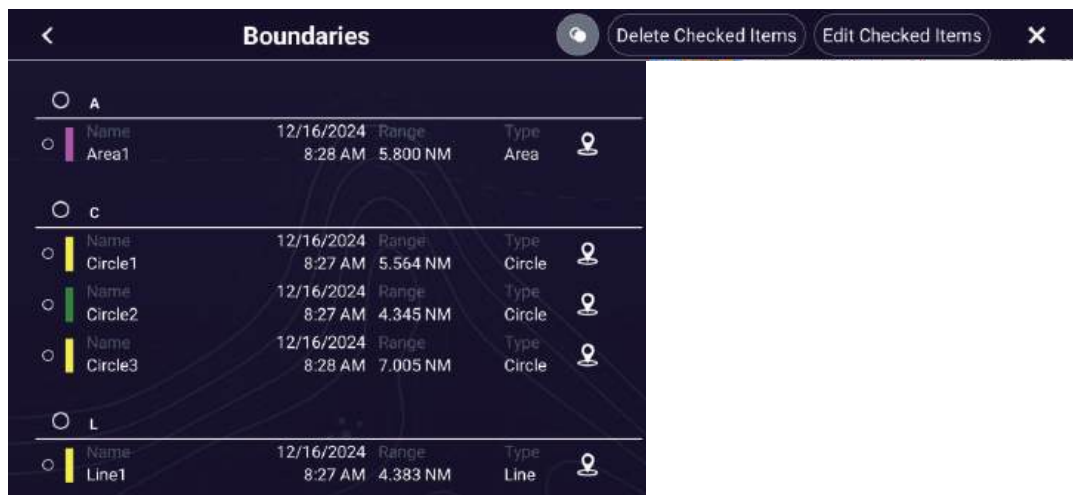

4. Tap the hollow circle to the left of the point to fill the circle in white, or tap an alphabet to edit all points that begin with that alphabet. For example, in the [Points] list above, tap "B" to delete the point names beginning with B.
5. On the title bar, tap [Delete Checked Items]. A message asks if you are sure to delete checked boundaries. Tap [OK] to delete the boundaries.

How to delete all boundaries

1. Home page→[Settings]→[Points & Boundaries].
2. Tap [Delete All User Objects]. The message "Are you sure you want to delete all your user objects (marks, routes, boundaries) from this device and all other networked devices? If the cloud synchronization is enabled, this will also remove all user objects from any devices connected with the same TIMEZERO account. This action cannot be undone." appears.
3. Tap [OK].
4. Tap [x] on the title bar to finish and close the menu.

4. POINTS, BOUNDARIES

This page is intentionally left blank.

5. ROUTES

5.1 What is a Route?

In order to sail from one point to another, it is necessary to change the course several times. The line that connects any two points on a journey is called a “leg” and the total legs on a journey is called a “route”. When you steer along a route, your TZMAP9/13 or TZT9E/13E automatically switches to the next point on the route, and provides information for steering, such as direction and distance to a point.

The equipment can store a maximum of 200 routes, with a maximum of 500 points per route. With many routes on-screen, the display can become cluttered. To prevent this, inactive routes are collapsed and marked with the "sleeping route" icon, pictured below.



Once you have created a route, you can “navigate” along that route. The route used for navigation is called the “active route”. During route navigation, the route leg currently being navigated is displayed as a solid purple line with several moving arrows that move in the direction to follow. Route legs that have been navigated are marked with a light gray line.

On-screen routes can be edited from the Pop-up menu. The following editing features are available:

- Insert route points in a route
- Move route points in a route
- Delete route points from a route
- Extend a route
- Find information about a route
- Delete a route
- Restart navigation after setting new course
- Follow a route in the reverse direction

Note: Active routes can be shared with other compatible units via LAN. Data is shared automatically; no operation is required. This feature is available for the TZT9E/13E only.

5.2 How to Create a Route

Note: The size of routes and text font can be adjusted in the [Settings]→[General]→[This Display]→[Plotter Objects Size] (see section 16.1).

5.2.1 How to create a route by selecting positions

1. On the chart plotter display, tap the location for the 1st point in the route to display the Pop-up menu.
2. Tap [New Route]. The flag mark () appears on the selected position and the Navigation bar appears (at the top of the screen).
3. Tap the flipswitch at the bottom of the screen to enable [Manual].

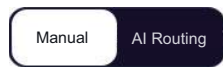
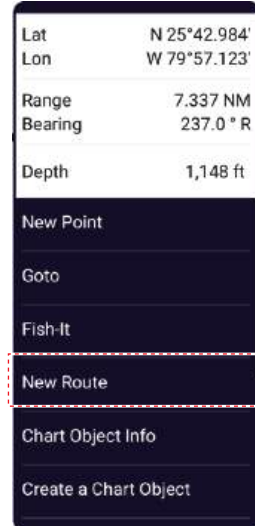

4. Tap the next route point in the route. A light-blue line with arrows runs between the previous route point and the next route point. The arrows points in the direction of route flow.

Note: When the [Intelligent Route Waypoint Centering] setting in the [Routes] menu is set to on, the display position moves so that the tapped point to be set as a route is in the center of the screen.
5. Tap the next route point in the route. Repeat this step to enter all route points. The Navigation bar shows the distance between last two points, bearing between last two points, total distance of route, total route duration.

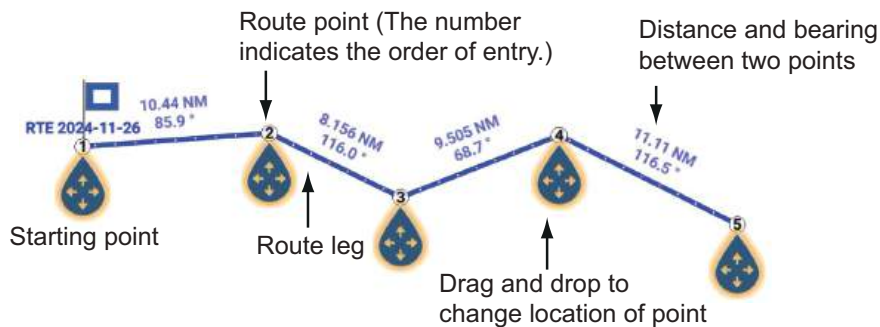
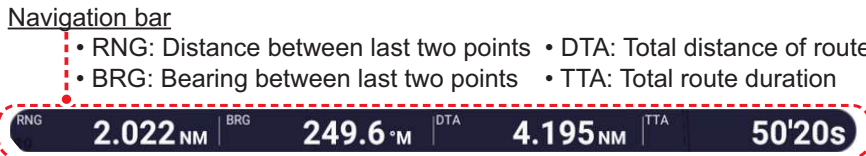

6. At the last route point, tap [End Route] at the top right-hand corner of the screen to complete the route. A software keyboard for entering the [Route Name] appears. The default route name is "RTE xxxx-xx-xx" (xxxx-xx-xx: creation date).
7. Enter a route name, then tap [✓] to confirm. The route is saved to the [Routes] list. The Navigation bar shows the total distance of route, total route time, estimated time of arrival, and speed over the ground.

Note 1: The route created above is called an "inactive route". When you create a new route or tap another route, that route becomes a "sleeping route".



Note 2: The points used to create a route by the above method are not saved to the [Points] list.

5.2.2 How to create a route with previously entered points

You can create a route with points (including event marks) you have previously entered.

1. Tap a point to display the Pop-up menu.
2. Tap [New Route]. The flag mark appears on the selected position and the Navigation bar appears (at the top of the screen).

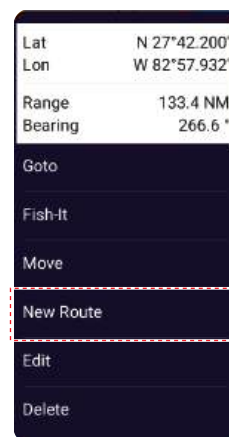

3. Tap the flipswitch at the bottom of the screen to enable [Manual].

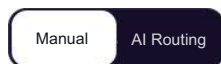

4. Tap the point to be the next route point. A light-blue line with arrows runs between the previous point and the next route point. The arrows point in the direction of route flow.
5. Tap the point to be the next route point. Repeat this step to enter all route points. The Navigation bar shows the distance between last two points, bearing between last two points, total distance of route, total route duration.

Navigation bar

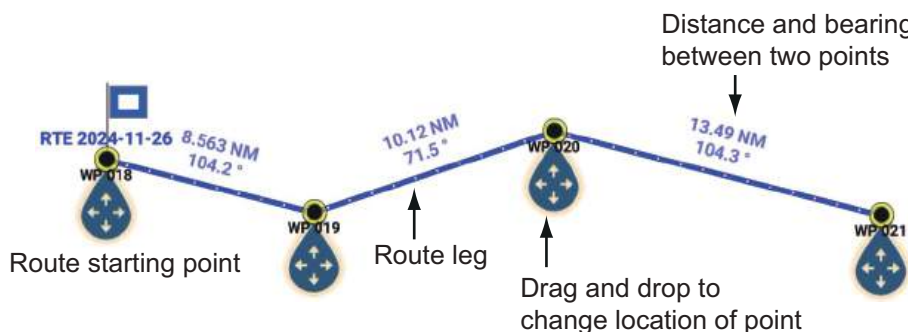

6. At the last route point, tap [End Route] at the top right-hand corner of the screen to complete the route.

5. ROUTES

- The window for entering route name appears. Enter route name then tap [✓] to confirm. The Navigation bar shows, to the last waypoint, the range, time-to-go, estimated time of arrival, and SOG.

Note: The route created above is called an "inactive route". When you create a new route or tap another route, that route becomes a "sleeping route".

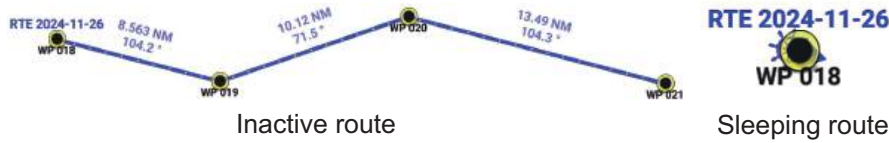

5.2.3 How to create a route from the Points list

- Home page → [Lists] → [Points].
- Tap the point to be the first point in the route.
- Tap [Add to Route], then tap [<] on the title bar to go back one layer in the list.
- Repeat steps 2-3 to enter all required points. The route is drawn on the preview screen on the right-hand side.
- Tap [x] on the title bar to close the [Points] list.

5.2.4 How to create a route automatically using the AI routing feature

The AI routing feature automatically creates a route it deems navigable, using a minimum of two points, start and end.

CAUTION

- AI routing creates routes that avoid land and shallow water, however 100% safety of the created route is not guaranteed. If [Use Vector Charts Recommended Route] (see section 5.17) is turned on and there are recommended route objects in the chart, they will be taken into account, but other navigational aids (cardinal beacon, lateral beacon, etc.) and navigation rules are not considered. AI routing also does not take into account restricted access areas, seaweed nets, oyster beds, etc. Be sure to carefully check the route you have created and navigate with extreme caution.

Note 1: Select [TZ MAPS] as the chart source. Purchase the TZ MAPS chart license for the area where you want to use this function and save the TZ MAPS chart information to a microSD card (see section 2.2). If the TZ MAPS chart license is expired, the function is not usable.

Note 2: Boat height and boat length are required for calculation of AI routes. Set them on the [Boat Information] menu (Home page → [Settings] → [Initial Setup] → [Boat Information] → [Boat Height] / [Boat Length]).

Note 3: When navigating a route using autopilot, do so at your own discretion and responsibility, taking into consideration vessel speed, course changes, obstacles, etc.

1. On the chart plotter display, tap the starting point for the route to show the Pop-up menu.
2. Tap [New Route]. The flag mark appears on the selected position and the Navigation bar appears (at the top of the screen).
3. Tap the flipswitch at the bottom of the screen to enable [AI Routing].

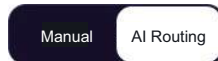

4. Tap the end point. The system begins creating the route.

Note 1: You can move the starting point and end point by dragging, and the route is recalculated immediately after moving. If the calculation takes a long time, an indication denoting this appears above the end point.

Note 2: To extend your route, tap the location where you want to extend the route. The point is inserted after the last point set.
5. Tap [End Route]. A software keyboard for entering the [Route Name] appears.
6. Enter route name then tap [✓] to confirm. The Navigation bar shows, to the end point, the range, time-to-go, estimated time of arrival, and SOG.

Route color	Meaning
Blue	The created route does not cross any of the locations listed in Note 1 below.
Red	The created route crosses at least one of the locations shown in Note 1 below.
Gray	<ul style="list-style-type: none"> • The starting point and end point of the currently creating route are connected by a gray straight line. • The created route that is determined to be non-navigable by the system (when tap to finish, the gray area is not registered as a route).
Brown	Failed to create the route. The starting point and end point are connected by a brown dashed line.

Note 1: If the route passes through the following locations, the route is shown in red.

- Sea areas shallower than the value set in [Safety Depth] (see Safety Depth on page 5-33).
- Under a bridge which is lower than the hull height.
- Targets on the sea such as buoys and beacons.
- Other locations where AI routing determines that caution should be taken when navigating.

Note 2: An error message may appear above the end point and the route is not created. For messages related to AI routing, see “AI Routing Related Messages” on page AP-25.

Note 3: AI routes that exceed 180° longitude cannot be created.

Note 4: The route points created by AI routing are displayed in the same color as the route.

5.3 How to Edit a Route

You can edit routes created manually or by AI routing.

Note 1: When editing a route created by AI routing, the route is automatically re-checked for hazardous locations.

Note 2: When the route is created by AI routing, moving the route point remarkably re-creates the route.

Note 3: If AI route is edited, the route may not be able to be navigated. Check that the edited AI route is navigable.

5.3.1 How to insert a route point into a route

You can insert a new route point on a route leg as follows.

1. Tap a position on a route leg where to insert a route point.
2. Tap [Insert] on the Pop-up menu. The compass symbol marks the position selected. The route point is numbered according to its position in the route, and the succeeding route points are renumbered.

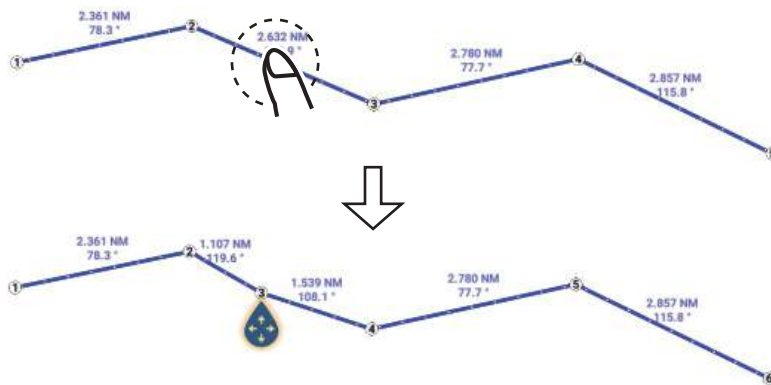

3. Tap [End Move] at the top right-hand corner of the screen.

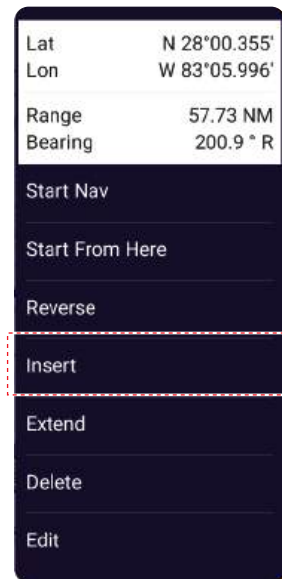

5.3.2 How to move a route point within a route

You can move a route point on a route as follows.

1. Tap a route point on a route to display the Pop-up menu. For example, point #3 in the figure below will be moved.



2. Tap [Move]. The selected route point is highlighted.

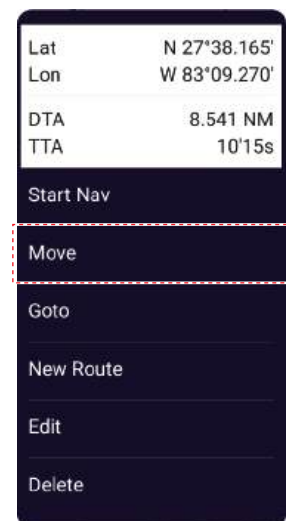

3. Move the route point to the new position by dragging the route point or tapping the new position.

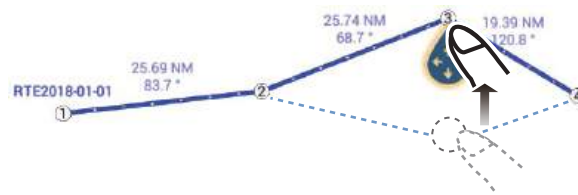

4. Tap [End Move] at the top right-hand corner of the screen.

5.3.3 How to delete a point on a route

You can delete a point on a route.

1. Tap the point to show the Pop-up menu.
2. Tap [Delete]. The selected point is deleted, and the succeeding route points are renumbered.

Note: If the waypoint you tapped in step 1 was a point icon, you can remove the point icon from the route, but the point icon is not be removed from the display.

5.3.4 How to extend a route

You can extend a route from the last route point on the route.

1. Tap a route leg to display the Pop-up menu.
2. Tap [Extend].
3. Tap a position. A light-blue line with arrow runs from the last route point to the selected position.
4. Repeat step 3 to enter more route points, if necessary.
5. At the last route point, tap [End Route] at the top right-hand corner of the screen to complete the route and save the route to the [Routes] list.

5.4 Routes List

The created routes are stored in the [Routes] list, where you can edit or see the route data. The list stores the following route data for each route:

- Name of route
- Total distance of route
- Color of route
- Comment for route
- Number (ID) of each route point
- Bearing to steer (to route point)
- Planning route speed (see section 5.17)
- Distance between legs and total distance
- TTG between legs and total TTG

5. ROUTES

How to show the Routes list

1. Home page→[Lists]→[Routes].

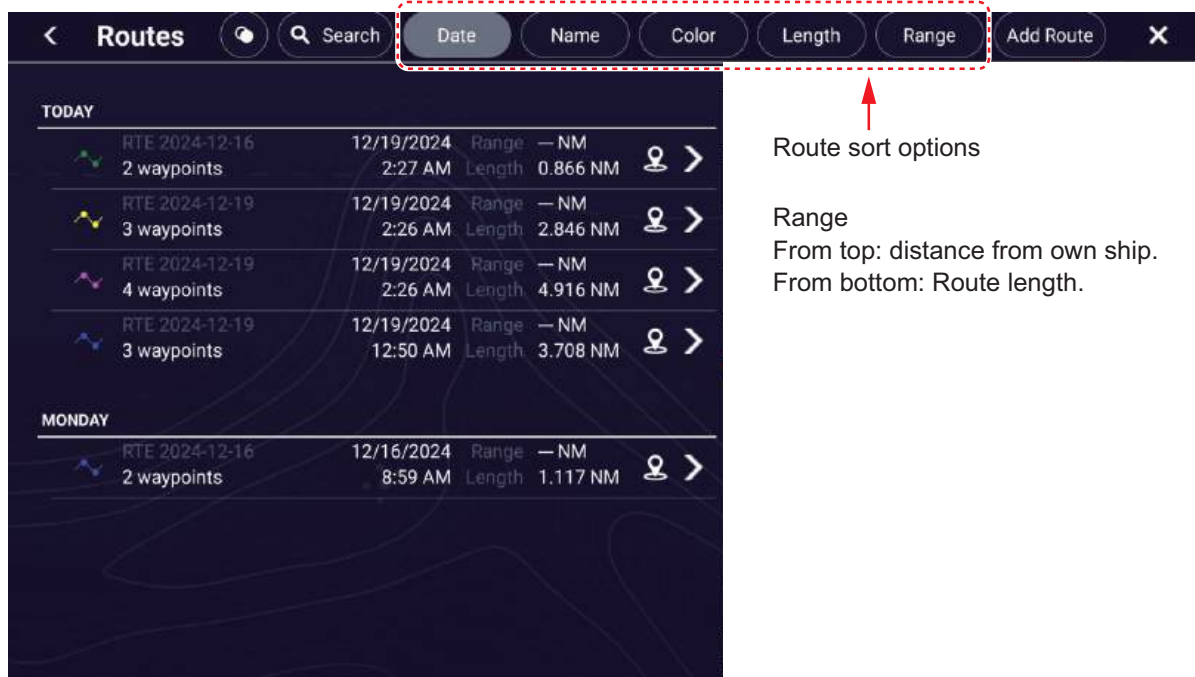

Tap icon to show the preview display on the right-hand side for the selected route.

2. To search the list, follow the applicable procedure on the next several pages.
[Date] Sort by date registered, in oldest-to-newest order.
[Name]: Sort by point name, in alphabet order.
[Color]: Sort by color.
[Length]: Sort by route length, from shortest to longest.
[Range]: Sort by range from own ship, from nearest to farthest.

How to search routes

Routes can be searched by character string, name, and color.

Search by character string

- 1) Tap the magnifying glass icon at the top of the screen to show the software keyboard.

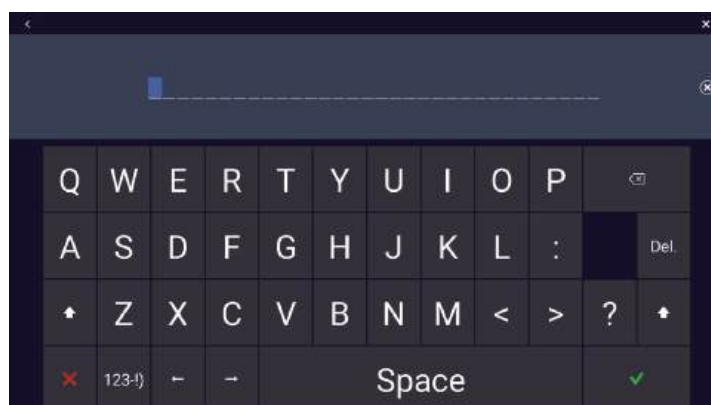

- 2) Enter search string (route's full name, or 2-3 characters), then tap [✓].
The route searched appears in the [Routes] list.

Search by name

- 1) Confirm that the sort method is selected to [Name].
- 2) Tap any alphabet in the list.

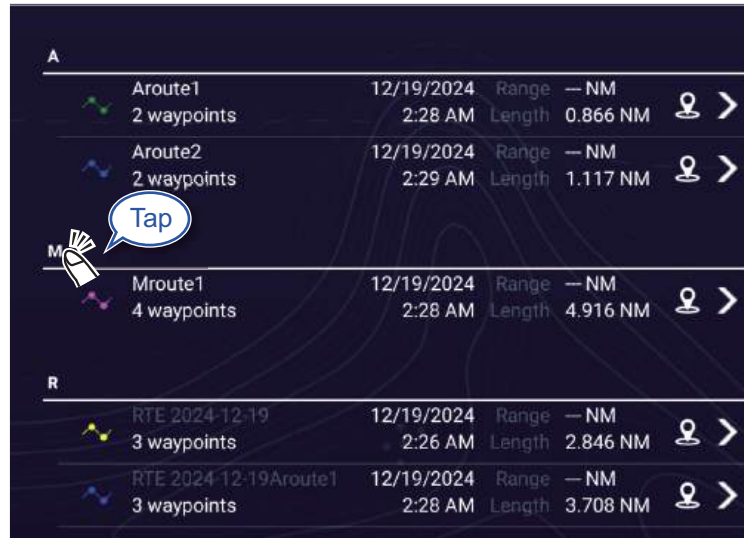

The search keyboard appears, with the searchable characters shown in blue.



5

- 3) Tap the letter to search.

Search by color

- 1) Confirm that the sort method is selected to [Color].

5. ROUTES

- 2) Tap any route color.

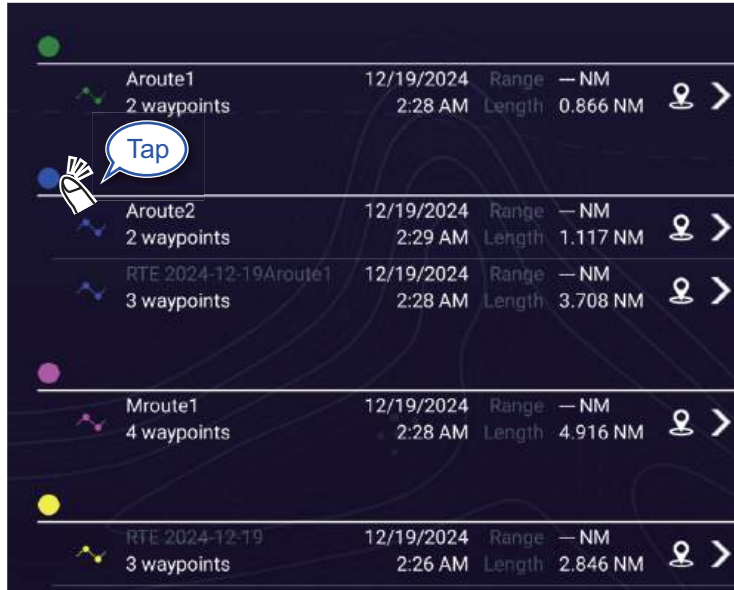

The color search panel appears. (The number of colors shown depends on the number of track colors used.)

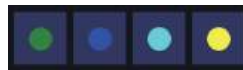

- 3) Tap the color to search. The routes corresponding to the color tapped appear in the [Routes] list.
3. Tap a route to find detailed information or to edit the route.

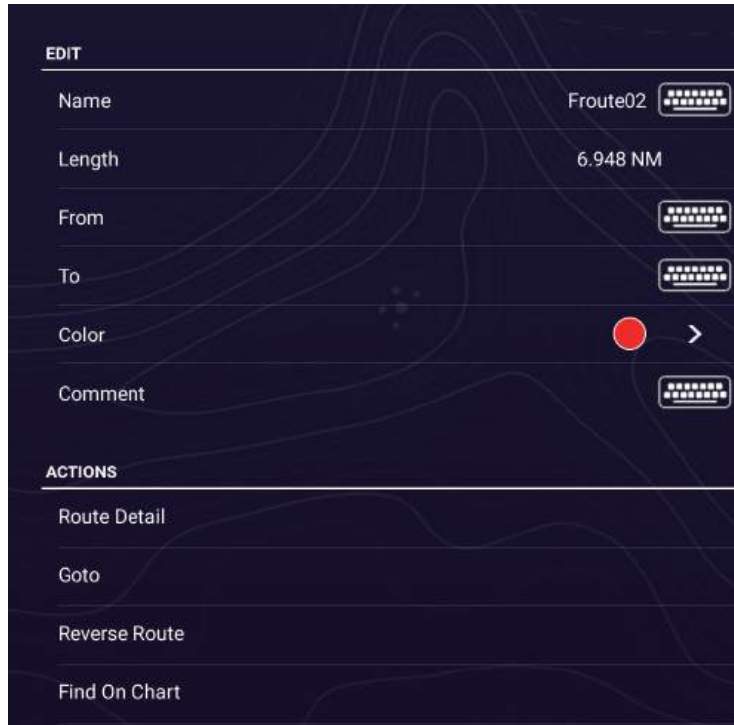

4. Tap the applicable item ([Name], [Length], [From], [To], [Color],[Comment]) to edit its content.

5. To find detailed information about a route, tap [Route Detail] to show route details.

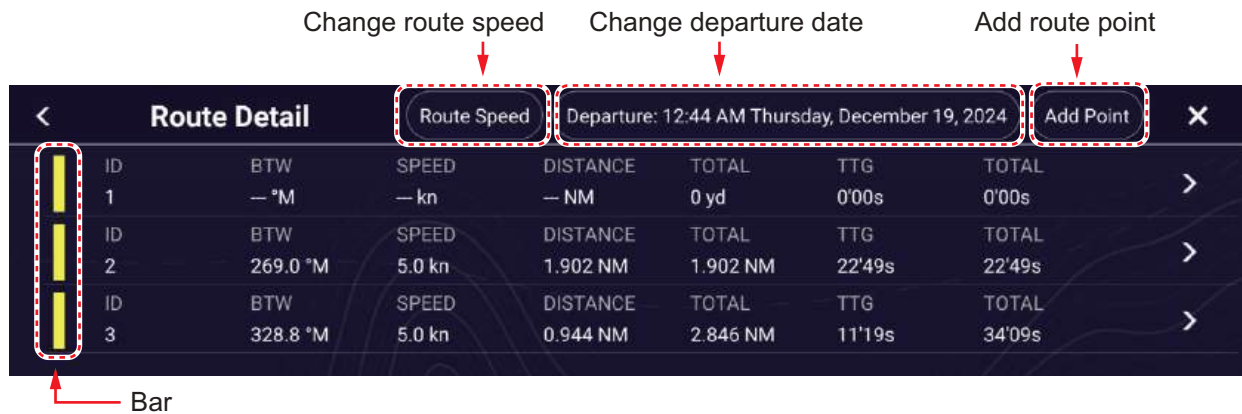

[ID]: Point no. ([Start] or [Goto])

[BTW]: Bearing to Goto point

[SPEED]: Speed to Goto point

[DISTANCE]: Distance from starting point

[TOTAL]: Total distance from start to Goto point

[TTG]*: Time to go to the Goto point, using speed shown in [SPEED] column.

[TOTAL]*: The time from start to the Goto point.

* Shown only when navigating a route.

Note: Detailed information can also be displayed as follows:

- Home page→[Lists]→[Planning Route Detail].
- Tap an on-screen route, then tap [Edit]→[Route Detail] on the Pop-up menu.

6. To edit a route from the [Route Detail] screen, tap the point to edit.

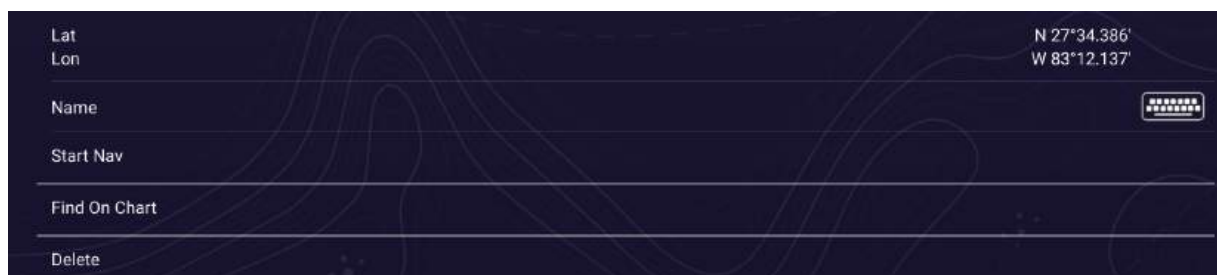

[Lat Lon]: Edit the latitude and longitude position of the point.

[Name]: Change the name of the point.

[Start Nav]: Start navigation from the point selected.

[Find on Chart]: Show the route of the selected point at the center of the chart plotter display.

[Delete]: Delete the selected point. Control is returned to the [Route Detail] screen and the points of the route are re-numbered.

7. Tap [x] on the title bar to finish and close the menu.

How to edit routes collectively via the Routes list

The  icon in the title bar allows you to edit routes collectively.

1. Home page→[Lists]→[Routes].
2. Use the sort buttons to sort the list as desired.

5. ROUTES

3. Tap the  icon. In the example list below the routes are sorted by name.

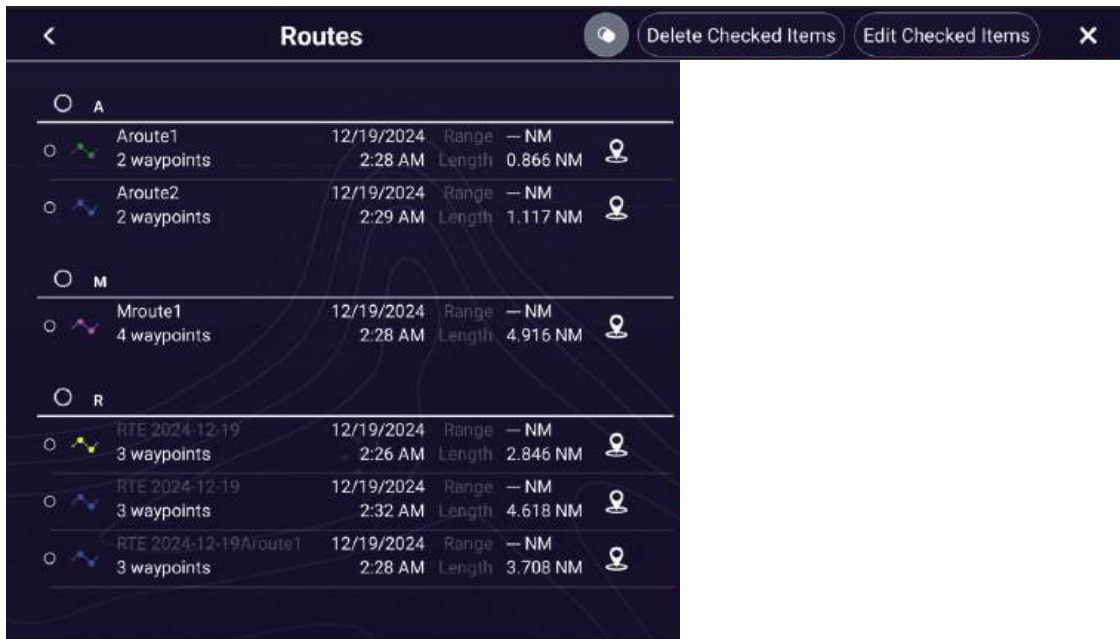

4. Tap the hollow circle to the left of the point to edit to fill the circle in white, Tap the circle to the left of the point to edit, or tap an alphabet to edit all points that begin with that alphabet. For example, in the [Routes] list above, tap “R” to edit all routes whose name begins with “R”.
5. On the title bar, tap [Edit Checked Items] to edit the checked routes. A screen similar to the one shown below appears.

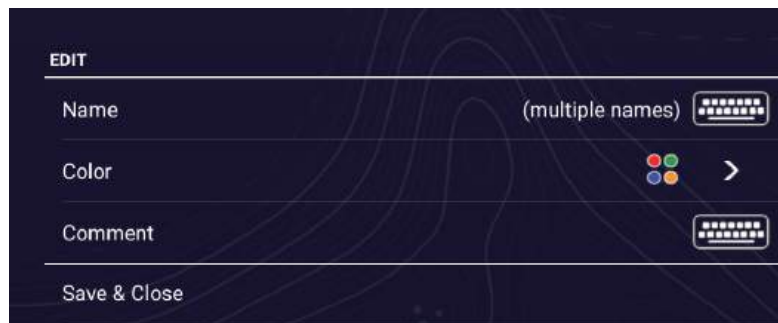

6. Edit route name, color or comment as appropriate.
7. Tap [Save & Close] to confirm changes and close the list.

5.5 How to Find Number of Routes Created

Home page→[Settings]→[General]→[Data Usage]. In the example below, five routes out of 200 have been created.

Points	12 / 30000
Routes	5 / 200
Areas & Lines	5 / 100
Circles	4 / 100
Photos	62 / 1000
Catches	4 / 1000
Track Points	65 / 100000

5.6 How to Find a Route on the Chart

You can easily find the location of a route from the [Routes] list. The selected route is put at the center of the active chart plotter display.

1. Home page→[Lists]→[Routes].
2. If necessary, use the list sort buttons at the top of the list to sort the list.
3. Tap a route.
4. Tap [Find On Chart].

The route is put at the center of the chart plotter display.

Note: If a split-screen chart plotter display is in use when searching for a route, the full-screen chart plotter display is restored and the route appears at the center of the screen.

5.7 How to Delete a Route

You can delete routes individually or collectively. An active route cannot be deleted.

5.7.1 How to delete a route on the screen

Tap a route leg of the route to delete to show the Pop-up menu, then tap [Delete].

Note: A route currently selected for navigation cannot be deleted.

5.7.2 How to delete a route via the Routes list

1. Home page→[Lists]→[Routes].
2. If necessary, sort the list with the list sort buttons on the title bar.
3. Tap the route to delete.
4. Tap [Delete]. The route is deleted from both the screen and the [Routes] list.
5. Tap [x] on the title bar to finish and close the menu.

5.7.3 How to delete routes collectively via the Routes list

The  icon in the title bar on the [Routes] list allows you to delete routes collectively.

1. Home page→[Lists]→[Routes].
2. At the top of the [Routes] list, choose how to sort the routes.
3. Tap the  icon. In the example list below the routes are sorted by name.

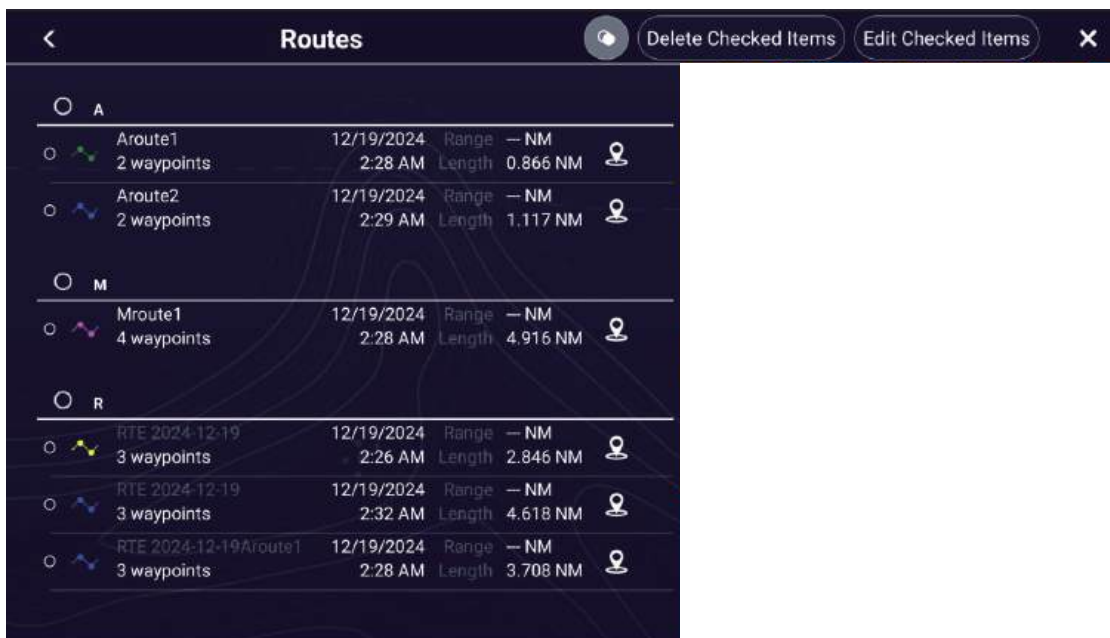

4. Tap the hollow circle of the route to delete to fill the circle in white, or check a sort title to delete all routes within that title. For example, in the [Routes] list above, tap "R" to delete all routes whose name begins with "R".
5. On the title bar, tap [Delete Checked Items]. A message asks if you are sure to delete checked routes. Tap [OK] to delete the routes.

5.7.4 How to delete all routes

1. Home page→[Settings]→[Routes]→[Delete All User Objects].
The message "Are you sure you want to delete all your user objects (marks, routes, boundaries) from this device and all other networked devices? If the cloud synchronization is enabled, this will also remove all user objects from any devices connected with the same TIMEZERO account. This action cannot be undone." appears.
2. Tap [OK].
3. Tap [x] on the title bar to finish and close the menu.

5.8 How to Show or Hide All Routes

All routes (including the route information box) can be shown or hidden. Open the Layers menu, tap the [User Objects] tab, then turn [Show Routes] on or off as required.

Note 1: An active route cannot be hidden from the screen unless route following is stopped.

Note 2: Inactive routes can be placed at either the arrival or departure location. Open the Layers menu, tap the [User Objects] tab, then turn on [Departure] or [Arrival] (below the [Routes] flipswitch).

5.9 How to Set Route Density

If you display all your routes, the screen can become cluttered with routes. To prevent this, set route density as shown below to limit the number of routes to show.

1. Home page→[Settings]→[Routes]→[Route Settings]→[Routes Density] to show the following options menu.

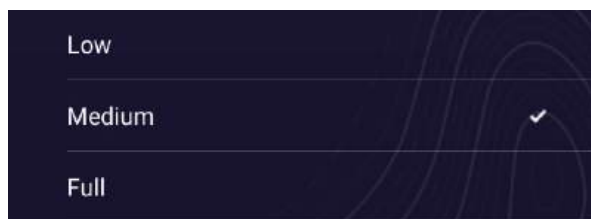

2. Tap desired route density. [Low] is the lowest route density, and [Full] displays all routes.
3. Tap [x] on the title bar to finish and close the menu.

5.10 How to Follow a Route

Before you follow a route, make sure that the path to the route is clear. Make sure to zoom your chart to check for hazards that do not appear on a smaller scale.

5.10.1 How to follow an on-screen route

1. Tap a route leg of the route to follow to show the Pop-up menu.
2. Tap [Start Nav]. The route now looks something like the one show in the figure below.

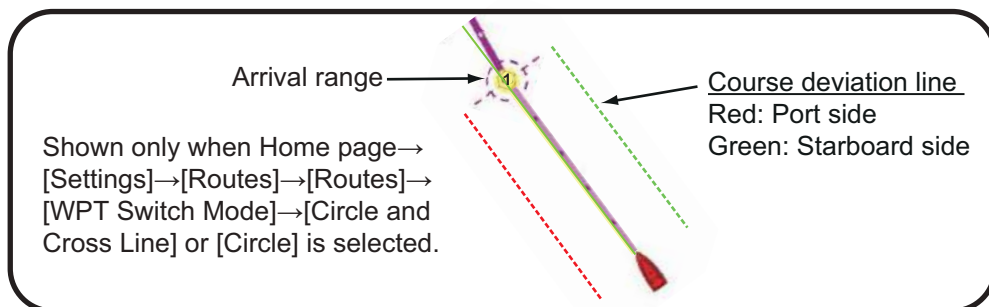
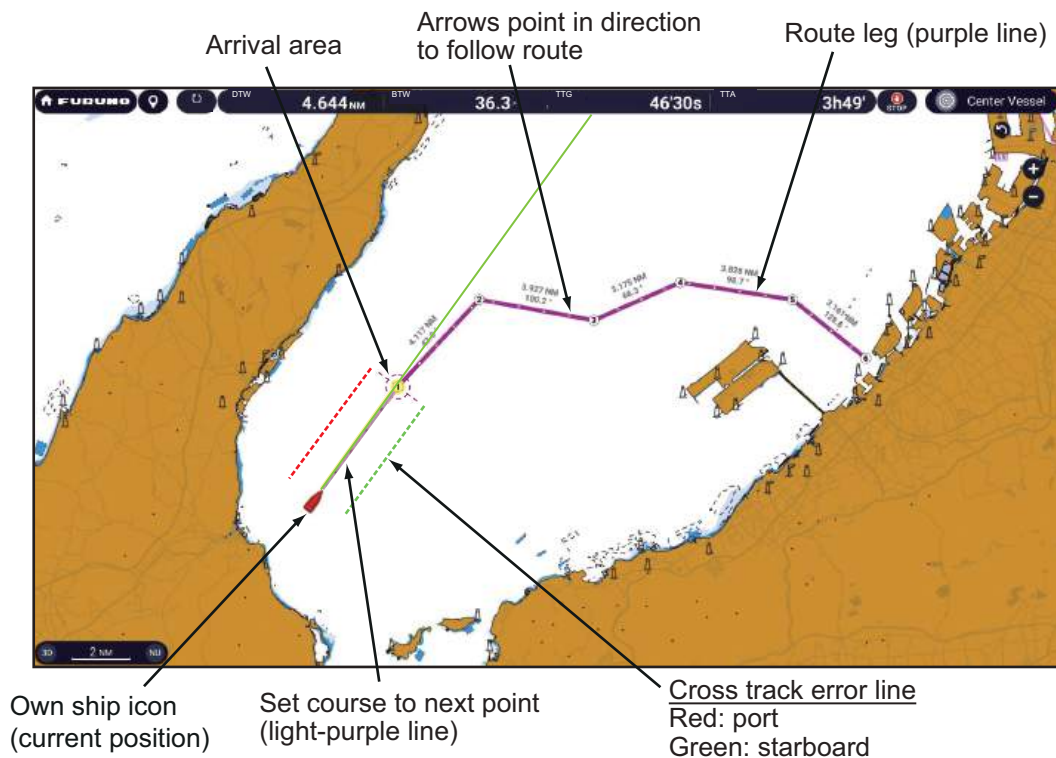

The following occurs:

- The color of the route becomes purple, and arrows on the route point in the direction in which to follow the route.
- The Goto point (1st route point) is highlighted.
- A solid purple line with arrows connects between current position and the points on the route. This line indicates the set course. A solid yellow line runs between current position and the destination. This line shows the shortest distance to the destination.
- The Navigation bar or Compass bar appears at the top of the screen (see page 4-20).

- Points are switch according the waypoint switching mode setting. To select the mode, Home page→[Settings]→[Routes]→[Routes]→[WPT Switch Mode]. Select [Circle and Cross Line], [Circle], or [Cross Line] as appropriate.
- The XTE lines, red for port side, green for starboard side, appear. You can show or hide these lines with [Cross Track Error Lines] in [Settings]→[Routes]→[Route Settings].

Note: If you want to be notified when you reach a Goto point, turn on [Waypoint Crossing Notification] on [Routes] of the menu (see subsection 5.11.8). Then the message "Waypoint Crossing" appears when you reach a Goto point. For the arrival timing, see subsection 5.11.5.

5.10.2 How to follow a route selected from the Routes list

1. Home page→[Lists]→[Routes].
2. If necessary, sort the list with the list sort buttons on the title bar.
3. Tap the route to follow,
4. Tap [Goto].
5. Tap [×] on the title bar to finish and close the list.

The following occurs:

- The color of the route becomes purple, and arrows on the route point in the direction in which to follow the route.
- The Goto point (1st route point) is highlighted.
- A solid purple line with arrows connects between current position and the points on the route. This line indicates the set course. A solid yellow line runs between current position and the destination. This line shows the shortest distance to the destination.
- The Navigation bar or Compass bar appears at the top of the screen (see page 4-20).
- Points are switch according the waypoint switching mode setting. To select the mode, Home page→[Settings]→[Routes]→[Routes]→[WPT Switch Mode]. Select [Circle and Cross Line], [Circle], or [Cross Line] as appropriate.
- The XTE lines, red for port side, green for starboard side, appear. You can show or hide these lines with [Cross Track Error Lines] in [Settings]→[Routes]→[Route Settings].

Note: If you want to be notified when you reach a Goto point, turn on [Waypoint Crossing Notification] in the [Routes] menu (see subsection 5.11.8). Then the message "Waypoint Crossing" appears when you reach a Goto point. For the arrival timing, see subsection 5.11.5.

5. ROUTES

5.10.3 How to start navigation from a route point

1. Tap the waypoint where you want to begin your route to show a Pop-up menu.
2. Tap [Start Nav].

In the example figure below, route point "3" was tapped.

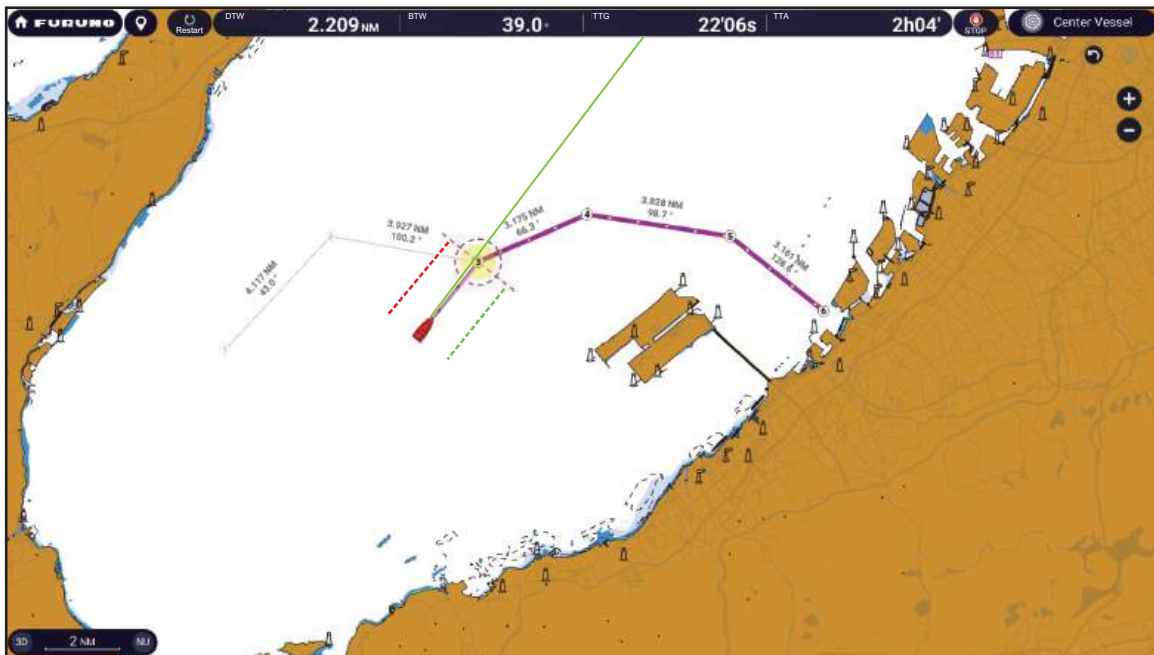

After tapping a route point, the following occurs:

- The route point "3" is selected to start navigation from, and is highlighted. Route points other than No. 3 are connected with a purple line. The arrows on the route point in the direction of route flow.
- The line between route points 1 and 2 and 2 and 3 are greyed out.
- A solid purple line with arrows connects between current position and the points on the route. This line indicates the set course. A solid yellow line runs between current position and the destination. This line shows the shortest distance to the destination.
- The Navigation bar or Compass bar appears at the top of the screen (see page 4-20).
- The arrival area marker appears if activated on the menu (see subsection 5.11.5).
- The XTE lines, red for port side, green for starboard side, appear. You can show or hide these lines and set their width with [Display XTE Lines] and [XTE Value] respectively in [Settings]→[Routes]→[Route Settings].

Note 1: To be notified when you reach a Goto point, turn on [Waypoint Crossing Notification] in [Settings]→[Routes]→[Route Settings] (see subsection 5.11.8). Then the message "Waypoint Crossing" appears when you reach a Goto point. For the arrival timing, see subsection 5.11.5.

Note 2: You can also start navigating a route from any location on a route leg. Tap anywhere on a route leg to show the Pop-up menu, then tap [Start from Here] to have that location become the destination.

5.10.4 How to show the detailed information about a route

1. Tap a route leg of the route to show the Pop-up menu.
2. Tap [Detail] to show the [Route Detail] window.

ID	BTW	SPEED	DISTANCE	TOTAL	TTG	TOTAL
Start	— °	— kn	0 m	0 m	0'00s	0'00s
1	271.6 °	49.9 kn	107.4 NM	107.4 NM	2h09'	2h09'
2	91.6 °	50.0 kn	3.558 NM	111.0 NM	4'16s	2h13'
3	91.8 °	50.0 kn	3.097 NM	114.1 NM	3'43s	2h17'
4	84.1 °	50.0 kn	2.819 NM	116.9 NM	3'23s	2h20'

3. Tap [x] on the title bar to finish and close the window.

Note: Detailed route information can also be shown with [Lists] on the Home page. Tap [Lists], then tap [Active Route Detail] (if there is an active route) or [Planning Route Detail]. For [Planning Route Detail], tap the route for which you want to see its details.

About the Route Detail window

The colored bars at the left edge of the window denote the status of each route point.

Blue: Indicates inactive route point. Planning route only.

Gray: A route point already transited.

Yellow: The route point your vessel is currently heading toward.

Purple: Route points that succeed current destination route point.

[ID]: [Start], or route point number

[BTW]: Bearing To Waypoint

[SPEED]: Speed used to calculate route details

[DISTANCE]: Distance to waypoints

[TOTAL]: Total distance of route

[TTG]: Time to Go between each route point*

[TOTAL]: Total time to go from start*

* Calculation based on [SPEED] value.

5.11 Operations Available When You Follow a Route

5.11.1 How to restart navigation

When you follow a route, you can restart the navigation to the next route point on the route from current location.

When you steer to keep away from an obstruction or the ship drifts, you go off course as shown in Line 1 in the figure. If you do not need to return to the original course, you can go to the route point from the current position as shown in Line 2 in the figure.

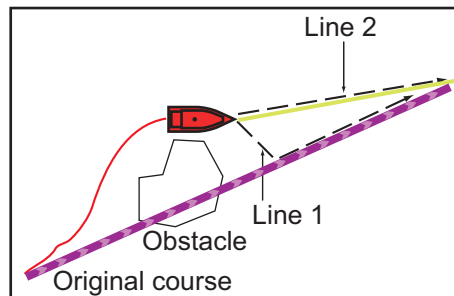

There are two methods to restart navigation:

From the Navigation bar

Tap the [Restart] button.

From the Pop-up menu

1. Tap a route leg, route course or the “shortest distance” line (yellow) to show the Pop-up menu.
2. Tap [Restart].
The route start position for the route moves to the current position.

From the Slide-out menu

Open the Slide-out menu, then tap [Route]→[Restart].

5.11.2 How to follow a route in the reverse direction

You can follow a route in reverse order. This helps you return along the same path.

Note: This function is not available for an active route.

1. Tap the route that you want to transverse in the opposite order to show the Pop-up menu.
2. Tap [Reverse].
The arrows on the route legs are in reverse direction and the numbers of the route points are in reverse order.

5.11.3 How to stop following a route

From the Navigation bar

Tap the [STOP] button.

From the Pop-up menu

1. Tap a route leg, route course or the “shortest distance” line (yellow) to show the Pop-up menu.
2. Tap [Stop Nav].
The arrival area, XTE lines, set course (purple line) and yellow line are erased from the screen. The default color for the route is restored.

From the Slide-out menu

Open the Slide-out menu, then tap [Stop Nav].

5.11.4 How to skip a point on a route

You can skip a route point to go to the succeeding route point in the route. Open the Slide-out menu, then tap [Route] and [Skip Next]. The current route point is skipped then the next route point becomes the destination. The skipped route point is greyed out.

5.11.5 Waypoint switching mode

When you arrive to a route point, your unit automatically changes to the next route point according to the waypoint switching mode selected on the menu.

[Circle and Cross Line]: Change the waypoint when one of the above two conditions is met.

[Circle]: Change the waypoint when the ship comes within the circle.

[Cross Line]: Change the waypoint when the ship moves through an imaginary cross line (vertical line) that passes through the center of the destination point.

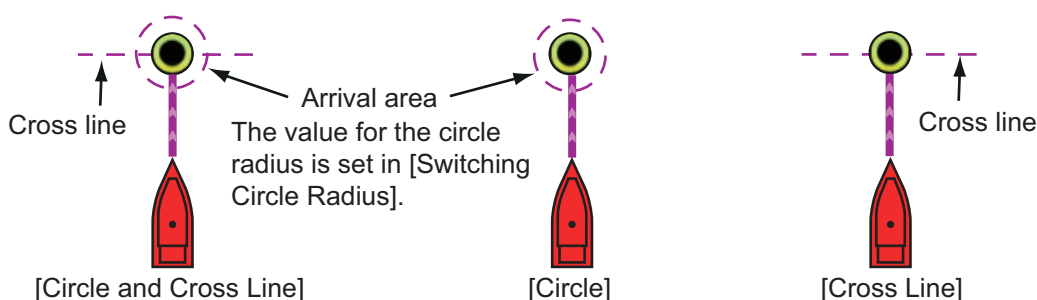

1. Home page→[Settings]→[Routes]→[Route Settings]→[WPT Switch Mode].
2. Tap [Circle and Cross Line], [Circle] or [Cross Line]. For [Circle and Cross Line] or [Circle], go to step 3. For [Cross Line], go to step 6.
3. Tap [<] on the title bar to go back one layer in the menu.
4. Tap [Switching Circle Radius] to show the software keyboard.
5. Enter the radius for the circle, then tap [✓]
6. Tap [×] on the title bar to finish and close the menu.

5.11.6 How to automatically zoom a route

You can get automatic range change after you have moved past the Goto point. Use this feature to find the next Goto point in the route when the next Goto point is not within the current display range.

1. Home page→[Settings]→[Routes]→[Route Settings].
2. Turn [Route Auto Zoom] on.
3. Tap [×] on the title bar to finish and close the menu.

5.11.7 XTE lines

The color of the XTE line is red for the port side, green for the starboard side. You can show or hide these lines and set their distance from own ship as follows.

1. Home page→[Settings]→[Routes]→[Route Settings].
2. Turn [Cross Track Error Lines] on or off.
On: Go to the next step.
Off: Tap [×] on the title bar to finish and close the menu.
3. Tap [Cross Track Error Value] to display the software keyboard.
4. Set the distance of the XTE lines from your ship then tap [✓].
 The XTE alarm sounds (if active) when your ship veers off course by the amount set here.
5. Tap [×] on the title bar to finish and close the menu.

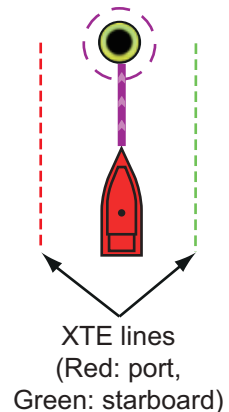

5.11.8 Waypoint arrival notification

The waypoint arrival notification feature releases audio and visual notifications when your ship reaches a Goto point. For the arrival timing, see subsection 5.11.5. The notification message "Waypoint Crossing" appears. Activate or deactivate this feature as follows.

1. Home page→[Settings]→[Routes]→[Route Settings].
2. Turn [Waypoint Crossing Notification] on to be notified when your vessel arrives at a waypoint.
3. Tap [×] on the title bar to finish and close the menu.

5.11.9 End of route notification

The end of route notification feature releases audio and visual notifications when your ship reaches the end of a route. For the arrival timing, see subsection 5.11.5. The notification message "End of Route" appears. Activate or deactivate this feature as follows.

1. Home page→[Settings]→[Routes]→[Route Settings].
2. Turn [End of Route Notification] on to be notified of end of route.
3. Tap [×] on the title bar to finish and close the menu.

5.11.10 How continue navigation at end of route

When you arrive at the final destination, you can keep the destination and route active. For example, if you set a destination on a small reef and continue fishing while going back and forth between the destinations, this function can save you from having to set the destination many times.

1. Home page→[Settings]→[Routes]→[Route Settings]→[End of Route Operation].

2. Tap [Continue Navigation].

The route is not canceled when arriving at the final destination, and the set course, XTE lines, bearing and range are displayed. For how to cancel the route see section 5.11.3. If an autopilot is connected, the ship turns after passing the final destination and continues to navigate around the final destination.

Note: The rudder may be suddenly turned depending on the autopilot and vessel speed.

To cancel route navigation after reaching the final destination, select [Stop Navigation].

3. Tap [x] on the title bar to finish and close the menu.

5.11.11 Steering a route with the NAVpilot

When you select a point to follow and the NAVpilot-700 series is connected and activated (see subsection 2.15.1) in the system, the message "DO YOU WANT TO NAVIGATE USING THE NAVPILOT?" appears. Tap [Yes] to have the NAVpilot steer the vessel, then the NAVpilot automatically goes into the NAV mode.

For the NAVpilot-300/1000, you are asked to select a navigation mode. Select [NAVpilot Precision Mode] or [NAVpilot Economy Mode]. ([Hand Steer] stops the NAV mode and reverts manual steering.) After selecting a mode, the NAVpilot-300/1000 automatically goes into the NAV mode.

NAVpilot precision mode: Keeps XTE within 0.01 NM

NAVpilot economy mode: Keeps XTE within 0.03 NM

Note: The example figure below shows the NAVpilot's display in the NAV mode. See subsection 2.15.3 for details.

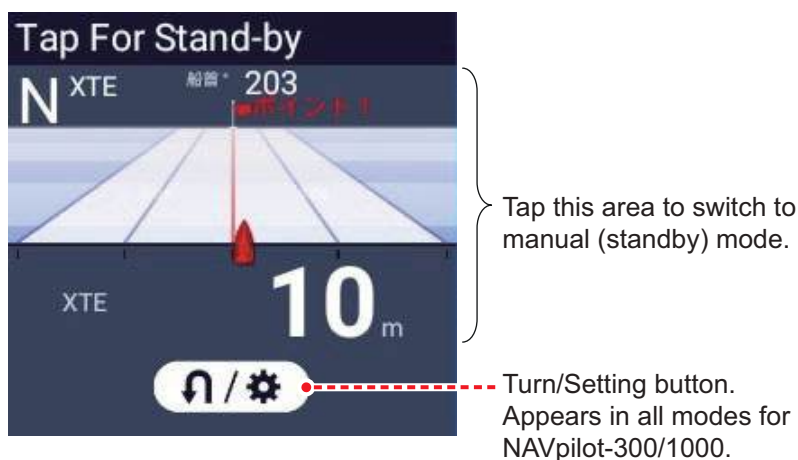

5.12 Risk Visualizer™ (TZT9E/13E Only)

Risk Visualizer™ calculates the speed of ARPA targets and own ship to look for possible collision with ARPA targets. If a possible collision is found, the collision area is graphically depicted on the chart plotter and radar displays.



WARNING

 • The Risk Visualizer provides reference information for avoiding approaches/collisions, but does not display information that takes all risks into consideration. Targets that are not captured by ARPA or lost targets are not part of an avoidance route. During actual navigation, the vessel operator is responsible for monitoring the surrounding area.

• Even if a ship is obliged to avoid collision, the avoidance route takes the ship's movement into consideration. In all cases, the operator(s) must follow the International Regulations for Preventing Collisions at Sea (IRPCS) and the rules of the area when deciding whether to give way or maintain course.

Note 1: This feature does not support AIS targets.

Note 2: This feature can calculate the risk of collision for a maximum of five ARPA targets (other ships). If there are more than five ARPA targets, the collision area is displayed in order from the one closest to your own ship.

Note 3: This feature's on/off setting is reflected to connected NavNet TZtouch series in the same network.

To activate the Risk Visualizer™, open the Layers menu on the chart plotter or radar display, tap the [Overlays] tab, then turn on [Risk Visualizer].

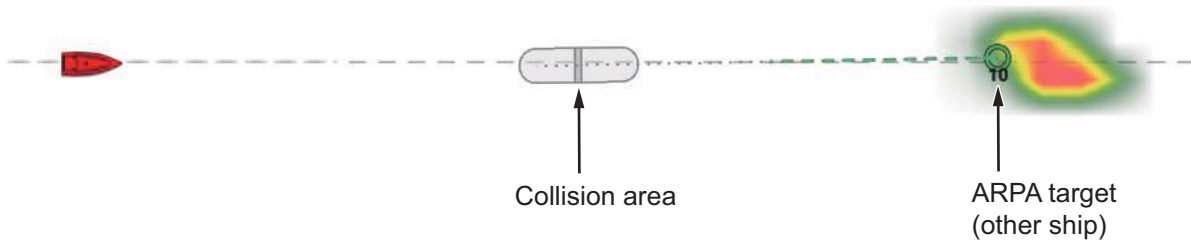

The Risk Visualizer™ calculated collision area is not shown in the following cases:

- a) When the collision area is not within the range where the ship's bow is $\pm 30^\circ$ and the ship's SOG (speed over ground) can reach within five minutes.
- b) The speed of the other ship is less than three knots.
- c) The COG (course to ground) of the other ship is $\pm 30^\circ$ from own ship's heading (as seen from own ship).

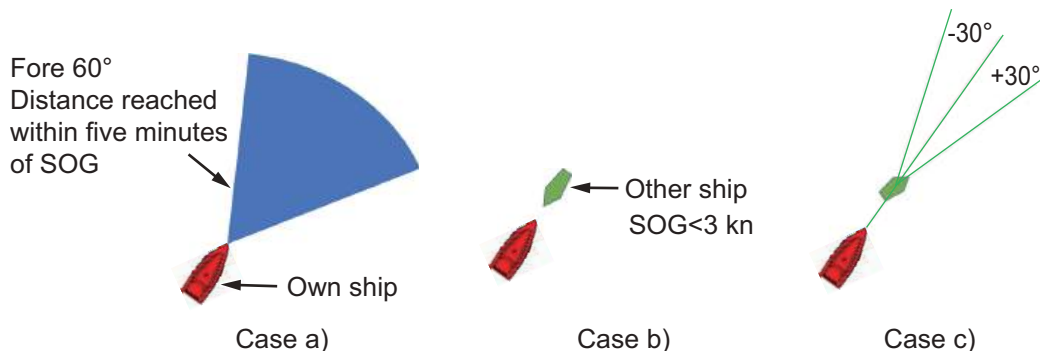

Risk visualizer alarm

To avoid collision with a ARPA target, set the [Collision Alarm] to [Risk Visualizer] to alert you to approaching ARPA targets. When the alarm is enabled, and your ship is within one minute of the collision area, the audio alarm sounds and the message "Risk Visualizer Alarm" flashes on the Status bar at the top of the screen.

1. Home page→[Settings]→[Targets]→[Collision Alarm],
2. Turn on [Risk Visualizer].
3. Tap [x] on the title to finish and close the menu.

5.13 Avoidance Route (TZT9E/13E Only)

If a possible collision with another vessel is detected during navigation, a route to avoid the collision, called an avoidance route, can be shown on the chart plotter display.

WARNING



- This function provides reference information for avoiding approaches and collisions, but does not display information that takes all risks into consideration. Avoidance routes to avoid targets that are not captured by ARPA or lost targets are not displayed. During actual navigation, the vessel operator is responsible for monitoring the surrounding area.
- Even if there is a duty to avoid on the target side, the avoidance route is displayed. Follow the International Regulations for Preventing Collisions at Sea (IRPCS) and the rules of the area when deciding whether to give way or maintain course.
- Even in situations where an avoidance maneuver is necessary, it may not be possible to display an avoidance route because the route is obstructed by land, shallow water, surrounding ships, etc. The vessel operator is responsible for taking measures to avoid danger.

Cautions and restrictions

Note 1: Requires radar sensor DRS2D-NXT/DRS4D-NXT/DRS6A-NXT/DRS12A-NXT/DRS25A-NXT, and position and heading input.

Note 2: Select [TZ MAPS] as the chart source. Purchase the TZ MAPS chart license for the area where you want to use this function and save the TZ MAPS chart information to a microSD card (see section 2.2). If the TZ MAPS chart license is expired, the function is not usable.

Note 3: AIS targets are not supported.

Note 4: The avoidance route is for display purposes. The route cannot be navigated.

Note 5: The avoidance route is not activated across all the TZT9E/13E units connected in the network. This function is activated on the TZT9E/13E unit that last activated it.

Note 6: This functions supports ship's speed up to 40 knots.

To activate the avoidance route, Layers menu→[Overlays] tab→turn on [Avoidance Route].

5. ROUTES

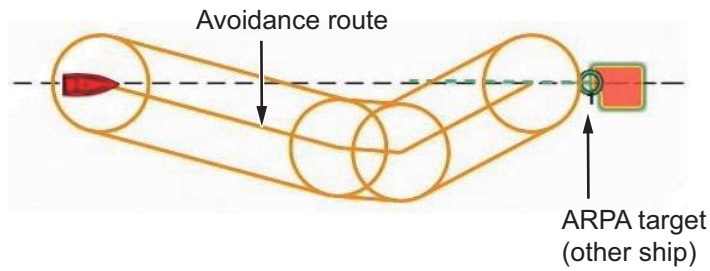

Note 1: When the [Full Auto Tracking Sea Condition] (see section 7.26.5) is currently OFF and [Avoidance Route] is turned ON, the [Full Auto Tracking Sea Condition] is automatically turned ON and set to [Moderate].

Note 2: When [Avoidance Route] is currently ON and the [Full Auto Tracking Sea Condition] (see section 7.26.5) is turned OFF, [Avoidance Route] is automatically turned OFF.

Activating both the [Risk Visualizer] and [Avoidance Routes] aids in navigation by showing you both collision areas and the routes to avoid them.

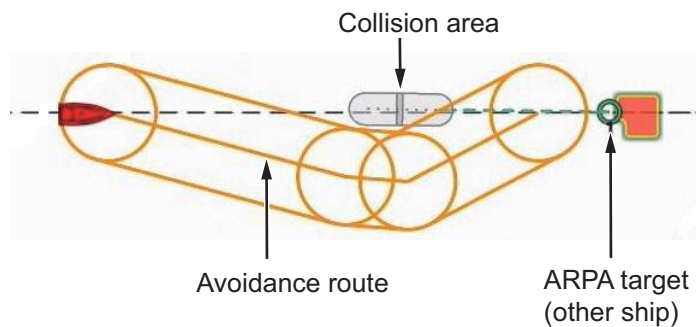

5.14 SAR Operations

The SAR (Search And Rescue) feature facilitates search and rescue, and MOB (Man Over Board) operations. This feature requires several installation menu changes and requires a qualified technician to make the necessary changes. To active this feature, contact your dealer.

1. On the chart plotter display, tap the location where you want to start SAR operations.
2. Tap [New SAR Pattern] on the Pop-up menu.

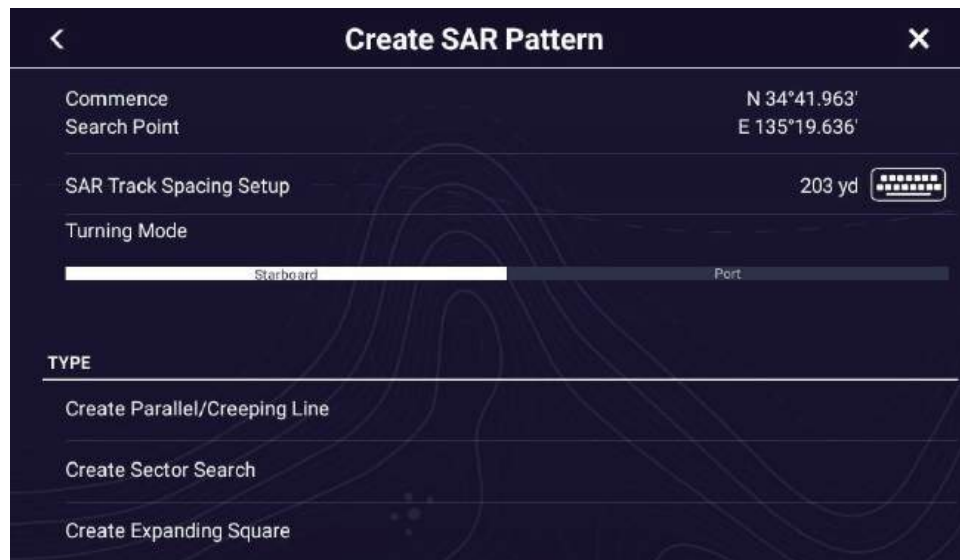

3. **Enter coordinates.** Tap [Commence Search Point] to show the software keyboard. Input the coordinates for the starting location, then tap [✓].
4. **Enter the length of the interval.** Tap [SAR Track Spacing Setup] to show the software keyboard. Set the distance between the SAR tracks, then tap [✓].
5. Tap [Starboard] or [Port] to select the direction in which to start the SAR pattern.
6. Tap the type of pattern you want to use. The following figures show examples for each of the patterns.

5. ROUTES

Type	Sample Pattern
[Parallel Creeping Line]	
[Sector Search]	
[Expanding Square]	

The screen shows the SAR and the SAR area, a dashed rectangle.

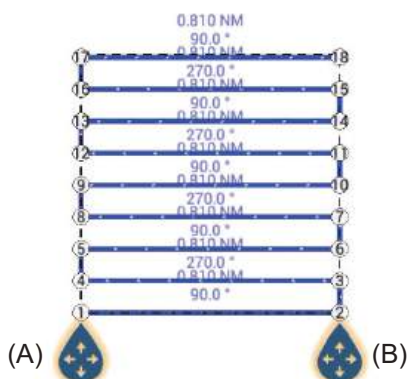

Example 1: Parallel/Creeping Line

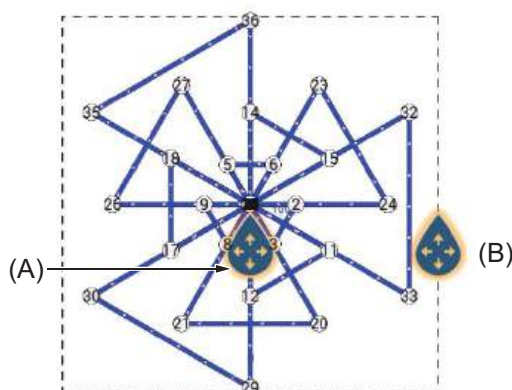

Example 2: Sector Search

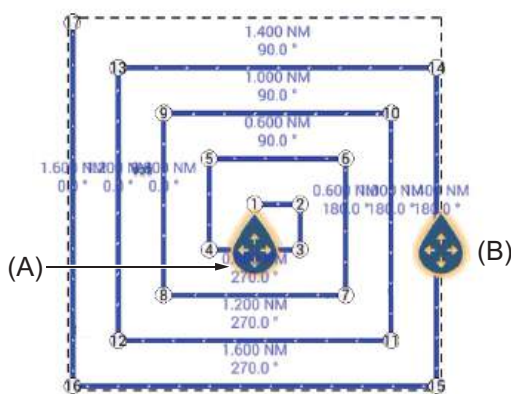

Example 3: Expanding Square

7. To change the search commence point, drag the icon marked as (A) in the figure above.
8. If necessary, change the bearing search area by dragging the icon marked as (B) in the figure above.
9. Tap [End SAR] to finalize the SAR area.
10. Tap [OK] to start SAR operations.
If the NAVpilot-700 series is connected and activated (see subsection 2.15.1) in the system, the message "DO YOU WANT TO NAVIGATE USING THE NAVPILOT?" appears. Tap [Yes] to have the NAVpilot steer the vessel, then the NAVpilot automatically goes into the NAV mode. For the NAVpilot-300, you are asked to select a navigation mode.
11. Select [NAVpilot Precision Mode] or [NAVpilot Economy Mode]. ([Hand Steer] stops the NAV mode and reverts manual steering.)
NAVpilot precision mode: Keeps XTE within 0.01 NM
NAVpilot economy mode: Keeps XTE within 0.03 NM

5.15 Fuel Level Indicators

This equipment provides indicators that show both the approximate location where you may run out of fuel and the distance you can travel with the remaining fuel. This function requires the NMEA 2000 PGN127489 (Engine Fuel Rate).

Fuel max range indicator (on route)

The fuel pump icon marks on the current route how far you can travel on the remaining fuel. To show this marker, tap [Settings]→[Routes]→[Route Settings]→turn on [Fuel Max Range].

Fuel range indicator (ring about own position)

The fuel range indicator draws a circle about own ship, the radius of the circle equivalent to the distance you can travel with the remaining fuel. To show this indicator, tap [Settings]→[Ship & Track]→[OwnShip]→turn on [Fuel Range Ring].

5.16 Laylines

A layline is the best course for route, calculated using wind speed and direction^{*1}, heading^{*1}, own ship speed^{*1} and tidal currents^{*2}.

*1: Appropriate sensors for these data are required to use the layline feature.

*2: Item set at section 5.16.1.

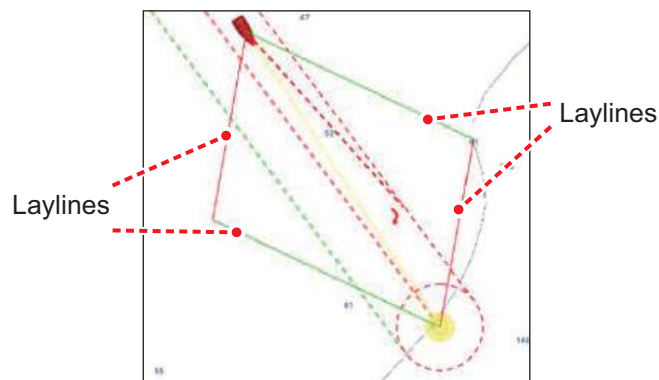

5.16.1 How to enable the layline feature

Home page→[Settings]→[Routes]→[Route Settings]→turn on [Sail Boat Laylines]. Tap the vessel icon, route waypoint or navigation line to show the Pop-up menu. Turn on [Laylines].

To apply tidal offsets to laylines, turn on [Tidal Offset for Laylines] in the [Routes]→[Route Settings].

5.16.2 How to show layline data in the Data window

1. Open the Data window, then tap [DATA] or [ROUTE] tab at the top of the Data window.
2. Tap the [EDIT] button at the bottom of the Data window to show the [Edit NavData] display.
3. Tap [+] (bottom of screen) to show the [Add NavData] window.
4. Tap [Layline Information]. Data for port-side and starboard-side appears in the Data window.

Layline Information	
Optimum Cap	345.2 °
Distance	1.663 NM
Time to go	20'59s
Optimum Cap	44.2 °
Distance	2.657 NM
Time to go	33'12s

5.16.3 How to change the polar wind file

This equipment comes with a pre-installed polar wind file. This file contains data for sailboats, helping to improve sailing performance, by applying the data to the laylines. Polar files can be downloaded from the MyTimeZero™ cloud service and imported to the TZMAP9/13 or TZT9E/13E.

1. From a your PC (internet connection required), access the following site (without quotation marks) "<https://furuno.mytimezero.com/#/tzt2/polars>".
2. Login to your MyTimeZero™ account.

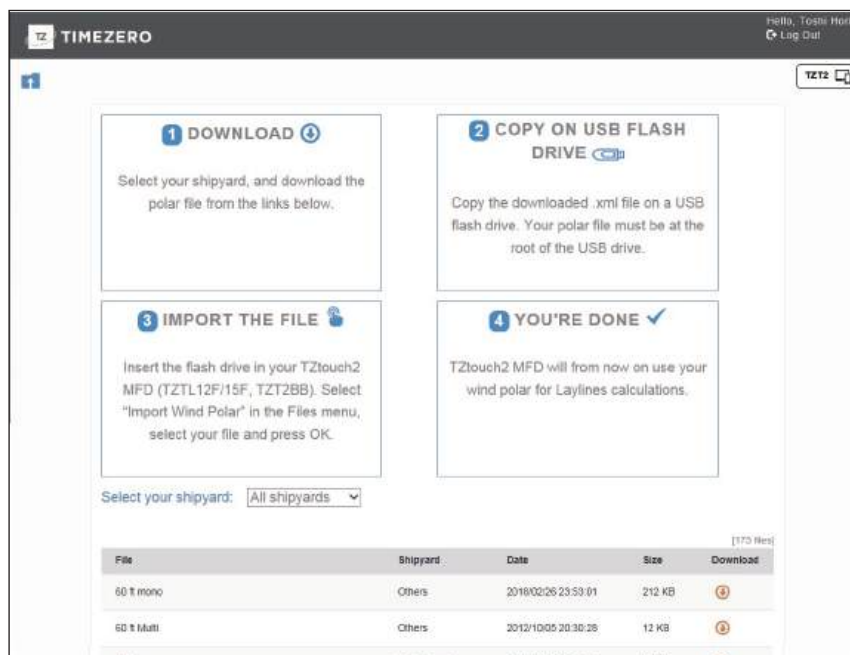

3. Download the required polar file and save the file to a USB flash memory.
Note: MicroSD card cannot be used.
4. Connect the USB flash memory to the TZT9E/13E USB cable.

5. ROUTES

5. On the TZMAP9/13 or TZT9E/13E, Home page→[Settings]→[Files] to show the [Files] menu.
6. Tap [Import Wind Polar]. The list of available polar wind files appears.
7. Tap the file you want to import, then tap [OK].
8. Check that the select file's name appears in the menu, directly below [Import Wind Polar].
9. Tap [×] on the title bar to finish and close the menu.

5.17 Routes Menu

This section provides descriptions for the items in the [Routes] menu not previously mentioned.

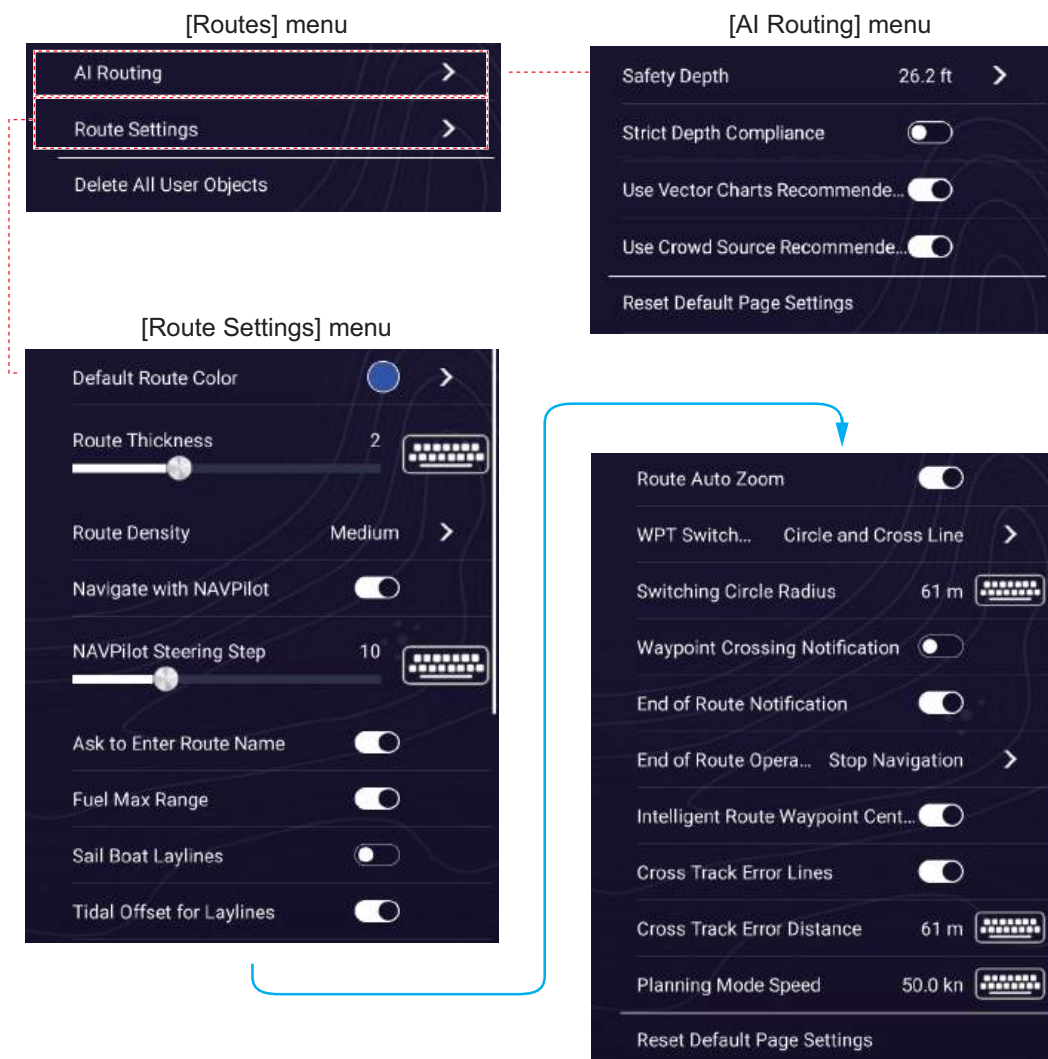

[AI Routing] menu

This menu provides settings for the automatically created routes (AI routing).

CAUTION

AI routing automatically creates routes according to the values set here, but routes that deviate from the set values may be created. Check all routes to confirm safe navigation.

[Safety Depth]: Set the safety depth value. AI Routing creates the route at a deepest possible water depth than the set value. If a route is created at a water depth shallower than the set value, the route is displayed in red.

[Strict Depth Compliance]: Select whether or not to strictly apply the safety depth set above. When activated, the route is not created shallower than the set safety depth value. However, if the **[Use Vector Charts Recommended]** or **[Use Crowd Source Recommended]** below is set to on, even if the water depth is shallower than the safety depth, a route that passes through the recommended route is generated.

[Use Vector Charts Recommended]: Choose whether or not to use the route recommended by the chart. With this feature activated, and there is a recommended route information registered in the chart, the route is created preferentially in the recommended route and the surrounding area in 5 m range.



[Use Crowd Source Recommended]: Choose whether or not to use the route recommended by information from sources other than charts, such as the Internet. Recommended popular cruising routes may be published on the Internet. The created route and the surrounding area is set as priority in 5 m range.

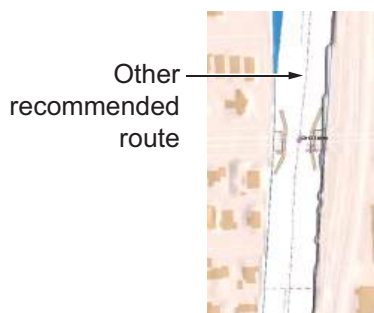

[Reset Default Page Settings]: Reset the items in the **[AI Routing]** menu to default.

[Route Settings] menu

[Default Route Color]: Select the color of the routes. The options are red, blue, green, yellow, pink, orange, light-blue, black.

[Route Thickness]: Select the thickness of the route legs.

[Ask to Enter Route Name]: Show the software keyboard to enter route name after you create a route. The default setting is "On".

5. ROUTES

[Intelligent Route Waypoint Centering]: Not used.

[Cruising Speed for Planning]: Set the ship speed to use to calculate the time required to reach destination. This item is linked to the speed data shown in the title bar of the [Route Detail] list, therefore if you change the ship speed value, the ship speed value in the [Speed] column of the [Route Detail] list also changes. See page 5-10.

[Reset Default Page Settings]: Reset the [Route Settings] menu settings to default.

6. FISH FINDER

This chapter describes the functions of the fish finder.

Note: The TZMAP9/13 does not support external fish finder or network connectivity with other NavNet TZtouch devices.

The fish finder is set up from the [Fish Finder] menu, which can be opened by the following two methods.

- Home page→[Settings]→[Fish Finder].
- Layers menu→[Settings].

Unless written otherwise, this manual uses the first method.

Note 1: To change the fish finder source (available for the TZT9E/13E only), Home page→[Settings]→[Fish Finder]→[User Settings]→[Fish Finder Source], then tap the source to use. The source can also be selected from the Layers menu, with [Fish Finder Source] in the [Fish Finder] tab.

Note 2: The names of menu items change according to the fish finder source.

Note 3: Do not use a dual-frequency CHIRP fish finder transducer and a CHIRP side scan transducer at the same time.

6.1 Fish Finder Layers Menu

The fish finder Layers menu has two tabs: [Fish Finder], and [Overlays].

[Fish Finder] tab: Provides selection of display mode, frequency, picture advance, etc.

[Overlays] tab: Shows or hides various overlays, selects day background color, controls the interference rejector, etc.

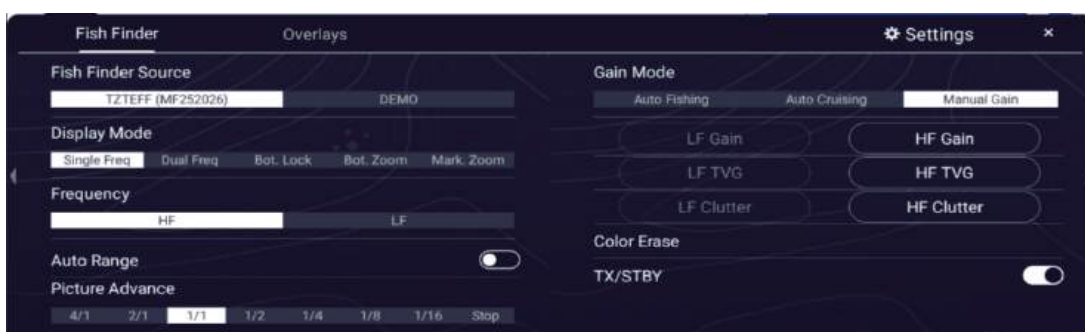

[Fish Finder] tab

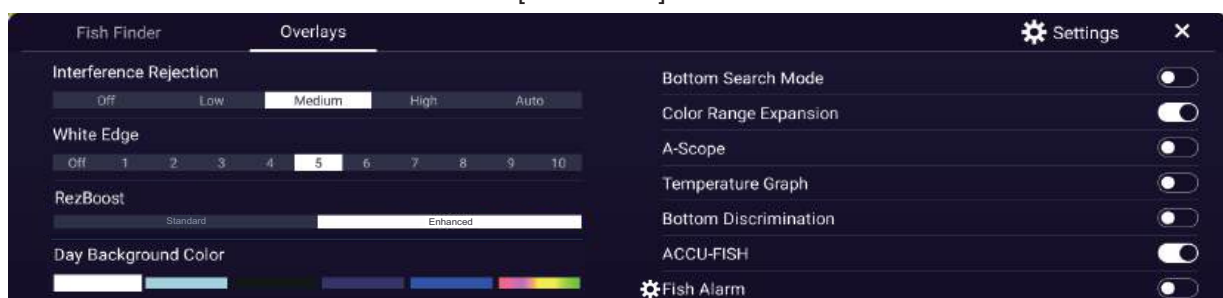

[Overlays] tab

6.2 How the Fish Finder Operates

The fish finder calculates the distance between its transducer and underwater objects like fish, lake bottom or seabed. The results are shown in different colors or shades of gray according to echo strength.

The ultrasonic waves transmitted through water move at a constant speed of approximately 4800 feet (1500 meters) per second. When a sound wave "hits" an underwater object like fish or sea bottom, part of the sound wave is reflected toward the source. To find the depth to an object, the fish finder calculates the time difference between the transmission of a sound wave and the time the reflected sound wave is received.

The picture displayed by the fish finder contains a series of vertical scan lines. Each line is a "picture" of the objects under the boat. The series of pictures are put side-by-side across the screen to show the contours of the bottom and echoes from fish. The amount of history of objects that have moved under the boat can be less than a minute to more than one minute depending on the picture advance speed.

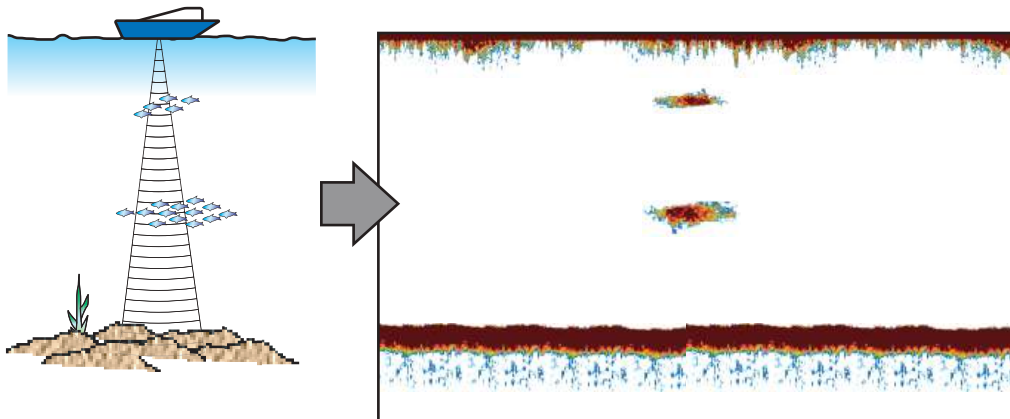

6.3 How to Start, Stop Transmission

Open the Home page, then tap the Fish Finder icon to activate the fish finder. Open the Layers menu, tap the [Fish Finder] tab, then tap the flipswitch [TX/STBY] to start or stop transmission. "Stand-by" appears at the screen center when in stand-by.

Note: When transmission is stopped, power consumption is reduced by approximately 1W.

6.4 How to Select a Display

Your fish finder has five display modes, single frequency, dual frequency, bottom lock, marker zoom, and bottom zoom. A-scope or bottom discrimination displays can also be displayed together with each of the five display modes.

6.4.1 Single frequency display

The single frequency display shows either the low-frequency or high-frequency picture over the entire screen. Select a frequency according to your purpose, considering the description on the next page.

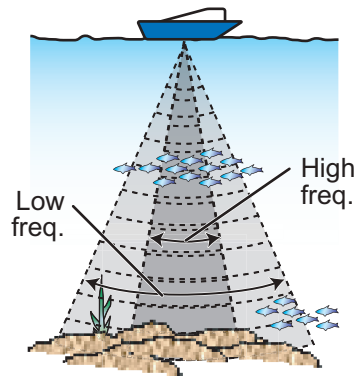

- A low frequency gives a wide detection area. Use the low frequency for general search and to find bottom conditions.
- A high frequency gives better resolution. Use the high frequency to inspect a school of fish in detail.

How to select a single frequency display

1. Open the Layers menu, then tap the [Fish Finder] tab.
2. Tap [Single Freq] at [Display Mode].
3. Tap [HF] or [LF] at [Frequency].

How to switch between the low- and high-frequency displays

You can switch between the low-and high-frequency displays by tapping the frequency icon, which is at bottom of the screen.

Note: In the same way as shown in the figure, you can switch the video on the side-by-side screen and enlarged screen explained in the following sections by the above method.

Side-by-side screen: Swap low frequency and high frequency images (factory default, low frequency on the left and high-frequency on the right).

Zoomed screen: Switch between single frequency (low frequency, high frequency).



Single Frequency Flipswitch



Left: Low Freq. Left: High Freq.
Right: High Freq. Right: Low Freq.

Dual Frequency Flipswitch

6.4.2 Dual frequency display

The dual frequency display provides both low and high frequency pictures, the low frequency on the left half (default). Use the dual frequency display to compare the same picture with two different sounding frequencies.

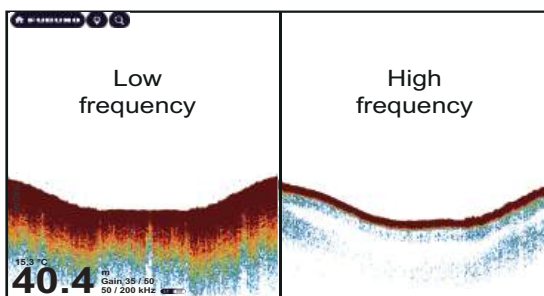

Freq. (kHz)	Beamwidth	Resolution	Detection range	Bottom tail
Low	Wide	Low	Deep	Long
High	Narrow	High	Shallow	Short

How to select the dual frequency display

On the Layers menu, tap the [Fish Finder] tab, then tap [Dual Freq] at [Display Mode].

How to set separate ranges for the low- and high-frequency displays

1. Home page→[Settings]→[Fish Finder]→[User Settings].
2. Turn on [Split Range].

Note: If the ACCU-FISH™ is active when [Split Range] is enabled, a message may inform you that it will be disabled, depending on your system configuration.

3. Tap [x] on the title bar to finish and close the menu.
4. Pinch the high- and low-frequency displays to change their range.

Note: The range buttons (⊕, ⊖) can be used to adjust the range of the image shown on the left-half of the screen.

6.4.3 Zoom displays

Zoom mode expands selected area of the single frequency picture. Three modes are available: bottom lock, bottom zoom, and marker zoom.

How to activate, deactivate a zoom display

Open the Layers menu, then tap the [Fish Finder] tab. Tap [Bot. Lock], [Bot. Zoom] or [Marker Zoom] at [Display Mode]. To quit the zoom display and go to the single frequency display, open the Layers menu, tap the [Fish Finder] tab, then tap [Single Freq] at [Display Mode].

Bottom lock display

The bottom lock display provides a compressed normal picture on the right half and a 7 to 400 feet (2 to 120 meter) wide layer in contact with the bottom is expanded on the left half. This display helps you separate the fish near the bottom from the bottom echo. You can select the bottom lock range with [Bottom Lock Range Span] in the [Fish Finder] menu.

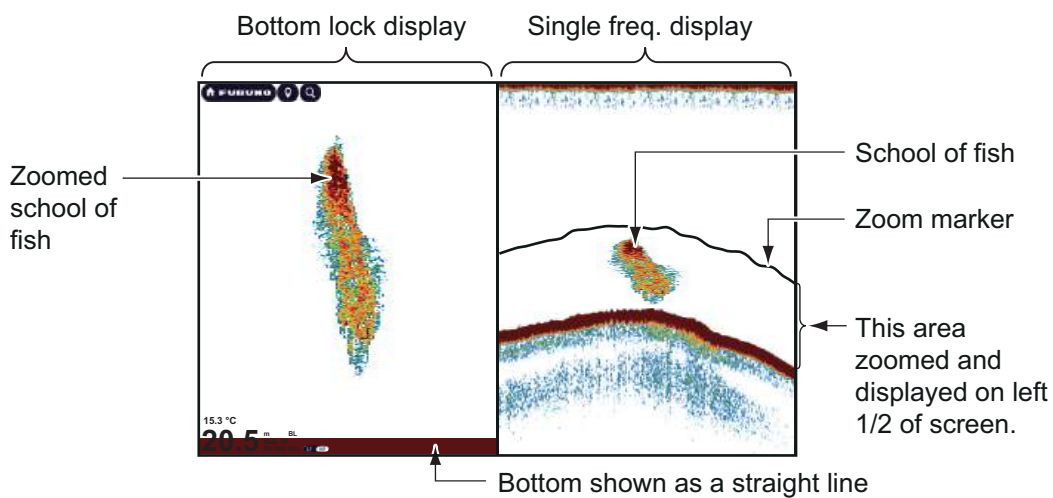

Bottom zoom display

The bottom zoom display expands the bottom and the fish near the bottom according to the zoom range selected on [Zoom Range Span] in the [Fish Finder] menu. This display helps you find the density of the bottom. A short echo tail normally indicates a soft bottom (sand bottom, etc.). A long echo tail indicates a hard bottom.

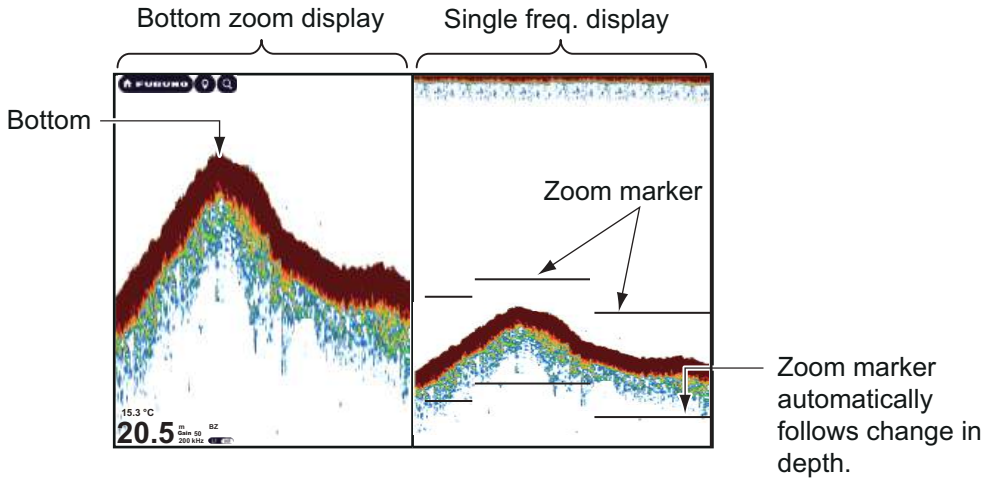

Marker zoom display

The single frequency picture is shown on the right half of the screen, and the area surrounded by the yellow enlargement marker on the right-half of the screen is enlarged on the left half. This display is useful for determining the size of a school of fish in the middle layer.

To change the range of the zoom marker, pinch on the screen, use the slider bar, or use the menu item [Zoom Range Span], in the [Fish Finder] menu. To shift the zoom marker (see section 6.5), drag it up or down on the screen, or use [Marker Zoom Shift] from the [Fish Finder] menu to set the start position (top of marker) of the zoom marker.

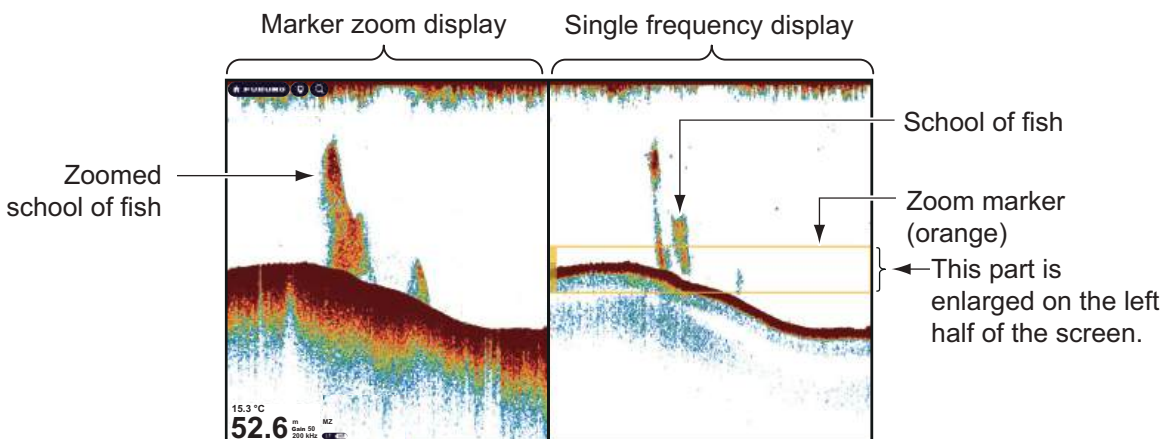

6.4.4 A-scope display (monitoring only)

The A-scope display appears at the right of the screen and is available in any display mode. This display shows the echoes at each transmission with the amplitudes and tone in balance with their intensities. This display helps you identify possible fish species and bottom structure.

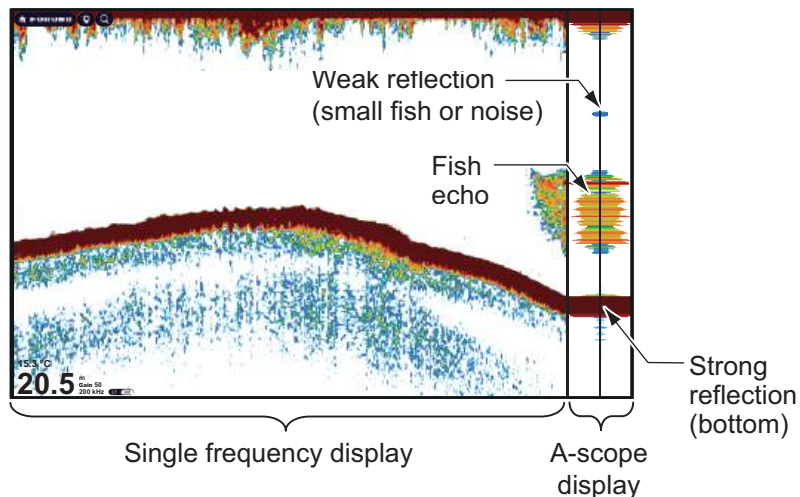

How to show or hide the A-scope display

Open the Layers menu, tap the [Overlays] tab, then turn [A-Scope] on or off.

A-scope peak hold

You can show the peak-hold amplitude image on the A-scope display. With [A-Scope Peak Hold] turned on, the image is slowly erased to help discern amplitude condition more easily.

1. Home page→[Settings]→[Fish Finder]→[User Settings].
2. Turn on [A-Scope Peak Hold].
3. Tap [×] on the title bar to finish and close the menu.

6.4.5 Bottom discrimination display

The bottom discrimination display, which requires the BBDS1, DFF1-UHD, DFF1UHD+, TZT9E/13E, TZMAP9/13, or a NavNet TZtouch3 or NavNet TZtouchXL (TZT10X/13X/16X), indicates a major component of the bottom among mud, sand, gravel, and rock. The display is available in all screen divisions, single or dual frequency mode, and occupies the bottom 1/6 of the screen in the full screen display.

Use this feature with ship speed 10 knots or less and depths between 5 and 100 m.

Note 1: Composition estimate accuracy may be affected when the transducer is not parallel with the seabed.

Note 2: Picture advance speed become slow while the bottom discrimination display is active.

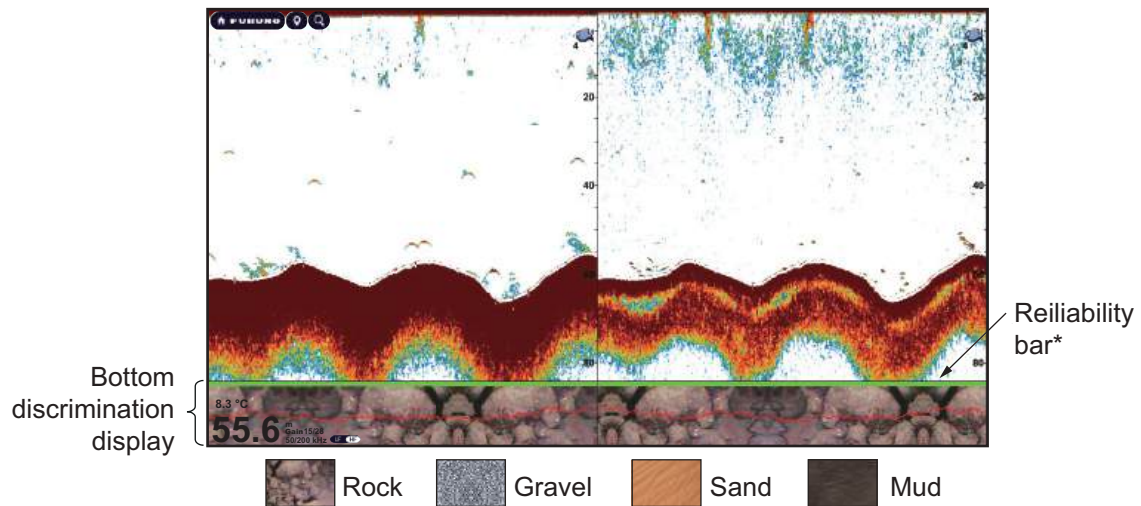

Sand and rock are the most likely bottom type in this example.

* Reliability of bottom discrimination display shown with a color.

- Green: Normal
- Yellow: Caution
- Background color: Abnormal

How to activate or deactivate the bottom discrimination display

1. Home page→[Settings]→[Fish Finder]→[User Settings].
2. Tap [Fish Finder Source]
3. Tap the desired fish finder source. Fish finder source can also be selected from the Layers menu, in the [Fish Finder] tab.
4. Tap [×] on the title bar to finish and close the menu.
5. On the Layers menu, tap the [Overlays] tab, then turn [Bottom Discrimination] on or off.

6

How to display bottom discrimination display information

Tap the bottom discrimination display to show bottom discrimination information, an example of which is shown below.

The bottom discrimination display can be turned off from the Pop-up menu with [Bottom].

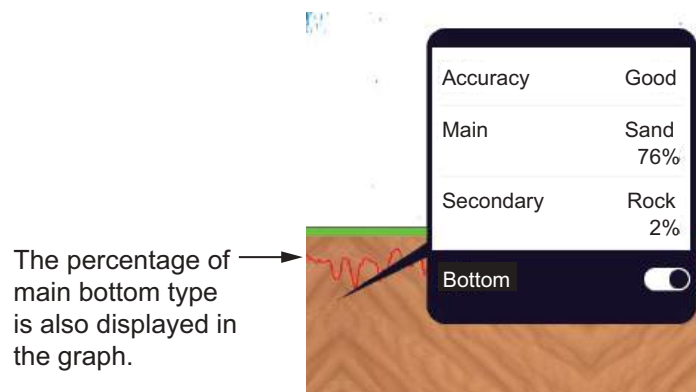

6.5 How to Select the Range

The range can be selected automatically or manually. To set the range selection method, open the Layers menu, tap the [Fish Finder] tab, then turn [Auto Range] on (automatic) or off (manual) as appropriate.

Automatic range selection: The range is automatically changed to display the bottom echo. For single frequency and dual frequency displays, the range buttons are hidden when auto range mode is enabled.

Manual range selection: Pinch the screen to change the range. Additionally, you can adjust the range with the range buttons (+, -) at the left edge of the screen. The buttons can be shown or hidden with [Show Range Buttons] (Settings→[Fish Finder]→[User Settings]).

How to shift the display range

You can shift the display range up or down to see deep or shallow place. This function is disabled during auto range operation. To shift the display range, drag the screen up or down.

6.6 How to Adjust the Gain

Gain can be adjusted automatically (two methods, fishing, cruising) or manually.

6.6.1 Automatic gain adjustment

The automatic gain adjustment feature is convenient when you don't have the time to adjust the gain (e.x. when you are busy with other tasks). With the automatic gain mode activated, gain, clutter, and TVG are automatically adjusted. The main functions of the automatic mode are as shown below.

- The gain is automatically adjusted to show the bottom echo in reddish-brown color.
- The clutter function removes weak echoes such as noise and plankton.
- TVG is automatically adjusted.
- The gain between low- and high-frequencies is automatically adjusted.

There are two types of automatic gain adjustment, fishing and cruising.

[Auto Fishing]: The gain is automatically adjusted to emphasize weak echoes from schools of fish. Use this mode for fishing. Select from the Layers menu ([Fish Finder] tab→[Gain Mode]). When this mode is active, the indication [Gain Auto F] appears at the bottom left corner.

[Auto Cruising]: The gain is automatically adjusted to suppress weak echoes and emphasize the bottom echo. Use this mode for cruising. Select from the Layers menu ([Fish Finder] tab→[Gain Mode]). When this mode is active, the indication [Gain Auto C] appears at the bottom left corner.

To select an automatic gain adjustment mode, open the Layers menu, tap the [Fish Finder] tab, then tap [Auto Fishing] or [Auto Cruising] at [Gain Mode].

6.6.2 Manual gain adjustment

To adjust the gain manually, open the Layers menu, tap the [Fish Finder] tab, then activate [Manual Gain] at [Gain Mode].

The gain controls how echoes of different strengths are displayed. Set the gain to show a slight amount of noise on the screen. Increase the gain for greater depths and lower the gain for shallow waters. The figures below show examples for gain set too high, too low and with a proper setting, for reference.

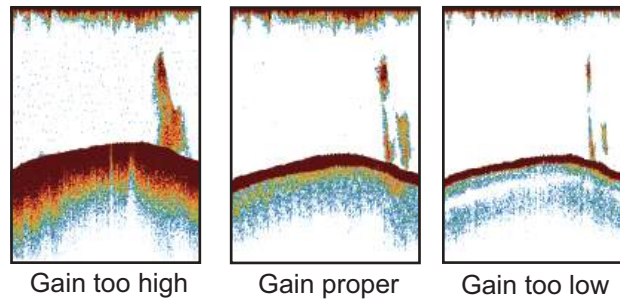

You can adjust the gain three ways.

Method 1: Layers menu

1. Open the Layers menu, then tap [xx* Gain] on the [Fish Finder] tab.
*: xx=transducer frequency indication, which changes according to transducer used.
2. With the slider bar at the right edge of the screen, drag the slider thumb or tap the (+, -) buttons to adjust the gain. The new gain settings is also reflected on past images displayed on the screen.

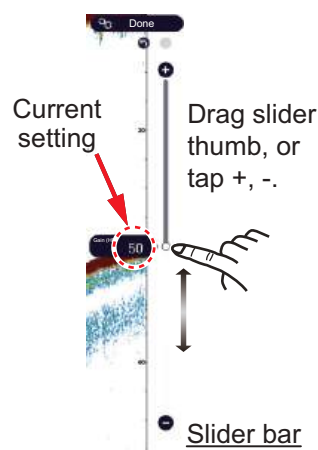

3. Tap [Done] at the top of screen to finish.

Method 2: Two finger (long) tap

Note: Set [Two Finger Tap Function] (or [Two Finger Long Tap Function]) to [Gain Control] in the [General]-[This Display] menu to enable on-screen gain adjustment. See section 1.16.

Tap (long tap) the screen with two fingers to show the Gain slider bar. Operate the slider bar referring to the illustration above.

Method 3: Fish finder, multi-beam sounder or CHIRP side scan box in Data window

Follow the procedure in section 1.9.2, section 1.9.3 to add [Fish Finder Gain Control], [Multi-Sounder Gain Control] or [CHIRP Side Scan Gain Control] in the Data window. Then, do as follows:

1. Show the fish finder display, multi-beam sounder display, (CHIRP) side scan display, or cross-section display. Tap [FISH FINDER], [DFF-3D], or [SIDE SCAN] at the top of the Data window.
2. Tap [M]/[A] to select Manual/Automatic.
3. Tap [xx* Gain] or the gain setting indication.
*: xx=transducer frequency indication, which changes according to transducer used.
4. With the slider bar at the right edge of the screen, drag the slider thumb, tap the slider bar, or tap the (+, -) buttons to adjust the gain.
5. Tap [Done] at the top-right corner of the screen to finish.

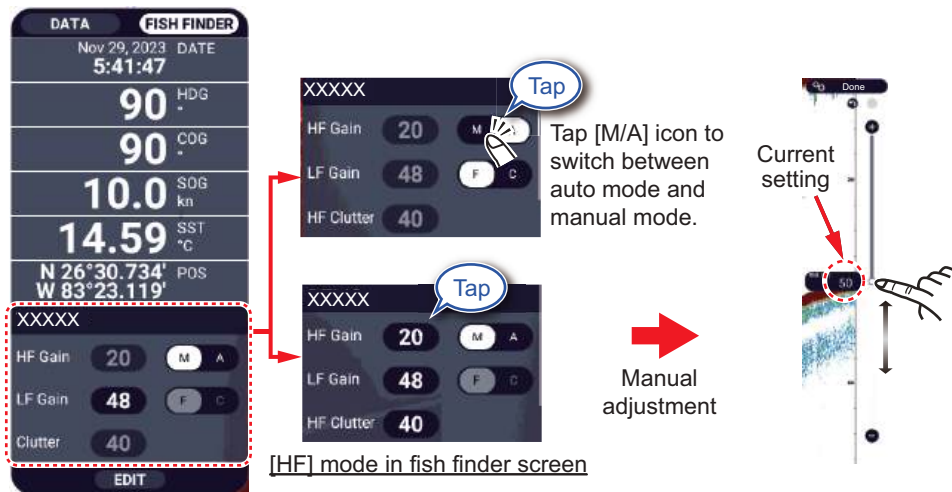

6.7 How to Reduce Clutter

Low intensity "spots" of noise appear over most of the screen like in the illustration shown right. These spots are caused by sediment in the water or noise. You can reduce this type of noise with the clutter function.

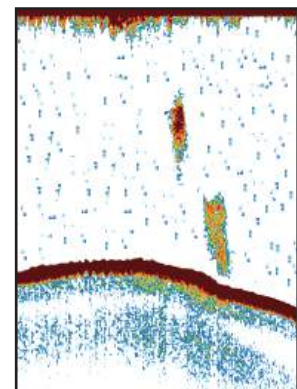

Note: This function is not available in the auto mode.

Method 1: Layers menu

1. Open the Layers menu, tap the [Fish Finder] tab, then tap [xx* Clutter].
*: xx=transducer frequency indication, which changes according to transducer used.
2. With the slider bar at the right edge of the screen, drag the slider thumb, tap the slider bar, or tap the (+, -) buttons to adjust the clutter. The larger the setting, the greater the degree of reduction.
3. Tap [Done] at the top right-corner of the screen to finish.

Method 2: Fish Finder menu

1. Home page→[Settings]→[Fish Finder]→[User Settings].
2. At [xx* Clutter], use the slider bar (or software keyboard) to set the degree of clutter reduction. The larger the setting, the greater the degree of reduction.
*: xx=transducer frequency indication, which changes according to transducer used.
3. Tap [x] on the title bar to finish and close the menu.

Method 3: Data window

Follow the procedure in section 1.9.2, section 1.9.3 to add [Fish Finder Gain Control] or [Multi-Sounder Gain Control] box in the Data window. Then, do as follows:

1. Show the fish finder display, multi-beam sounder display, side scan display, or cross-section display. Tap [FISH FINDER] or [DFF3D] at the bottom of the Data window.
2. Tap [xx* Clutter] or the clutter value icon.
*: xx=transducer frequency indication, which changes according to transducer used.
3. With the slider bar at the right edge of the screen, drag the slider thumb to adjust clutter.
4. Tap [Done] at the top right-corner of the screen to finish.

6.8 Picture Advance Speed

The picture advance speed controls how quickly the vertical scan lines move across the screen. A fast advance speed expands the size of a school of fish horizontally on the screen. A slow advance speed shortens the school of fish. Use a fast advance speed to see the hard bottom. Use a slow advance speed to see the smooth bottom.

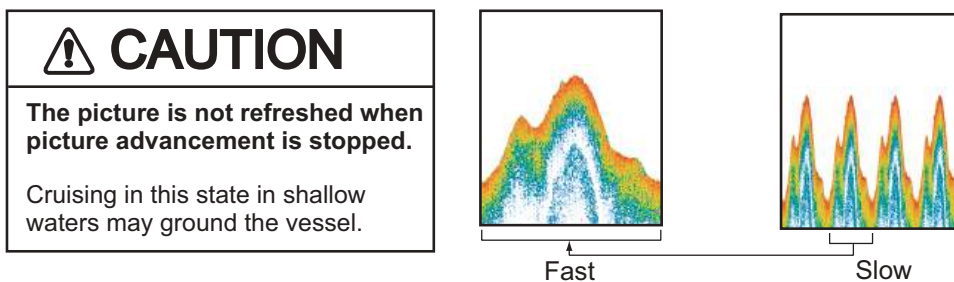

Note: The picture advances slightly slower when using ACCU-FISH™ or the bottom discrimination feature.

1. Home page→[Settings]→[Fish Finder]→[User Settings].
2. Tap [Picture Advance].
3. Tap a picture advance speed. [1/16] is the slowest speed, and [4/1] is the fastest. [1/16] means one scan line is produced for every 16 transmissions. [4/1] means four scan lines are produced for every transmission. [Stop] stops picture advancement, which is useful for taking a screenshot.
4. Tap [x] on the title bar to finish and close the menu.

Picture advance speed can also be set from the Layers menu, in the [Fish Finder] tab.

6.9 How to Reduce Interference

Interference from other fish finders and electrical equipment appears on the screen as shown in the illustration. When these types of interference appear on the screen, use the interference rejector to reduce the interference. Turn off the interference rejector when there is no interference, so that you do not erase weak echoes.

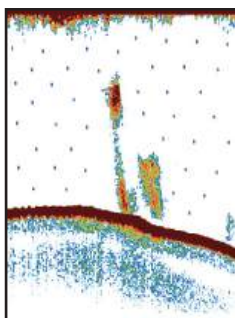

Interference from other sounder

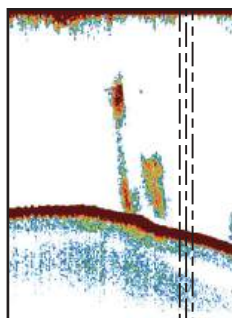

Interference from electrical equipment

1. Home page→[Settings]→[Fish Finder]→[User Settings].
2. At [Interference Rejection], tap [Low], [Medium], [High], or [Auto]. [High] provides the greatest interference rejection. [Auto] automatically selects suitable interference setting according to conditions. [Off] disables the interference rejector.

Note: If two sounders (especially, CHIRP transducer) in the network are used simultaneously, refer to the table below for interference rejector setting information.

Unit	Interference rejector setting
Other CHIRP sounder	Set to [Medium] or [High].
DFF-3D	[High]: With the DFF-3D's interference rejector also set to [High], you can reject interference from the built-in fish finder of the TZT9E/13E, NavNet TZtouch3, or NavNet TZtouchXL (TZT10X/13X/16X only) on the network, set from the Layers menu. See chapter 9.

3. Tap [x] on the title bar to finish and close the menu.

The interference rejector can also be set from the Layers menu, in the [Overlays] tab.

6.10 How to Erase Unnecessary Echoes

You can erase unnecessary echoes that fill the entire screen. Weaker echoes are erased sequentially to show only strong echoes and clear the picture.

1. Home page→[Settings]→[Fish Finder]→[User Settings].
2. Use the slider bar for [Color Erase] to set the level of echo erasure. Echoes are erased in sequential strength.
3. Tap [x] on the title bar to finish and close the menu.

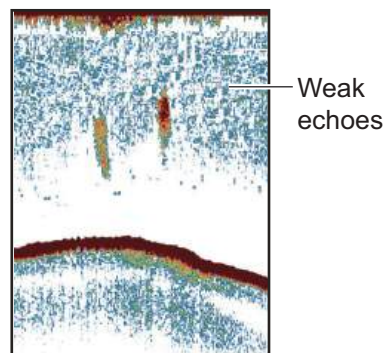

The [Color Erase] function can also be set from the Layers menu, in the [Fish Finder] tab.

6.11 How to Measure Range, Depth to an Object

You can measure the range and depth from the fish finder transducer to an object (school of fish, reef, etc.) with the VRM.

To display the VRM, tap an object. Read the range and depth to the object in the Pop-up menu.

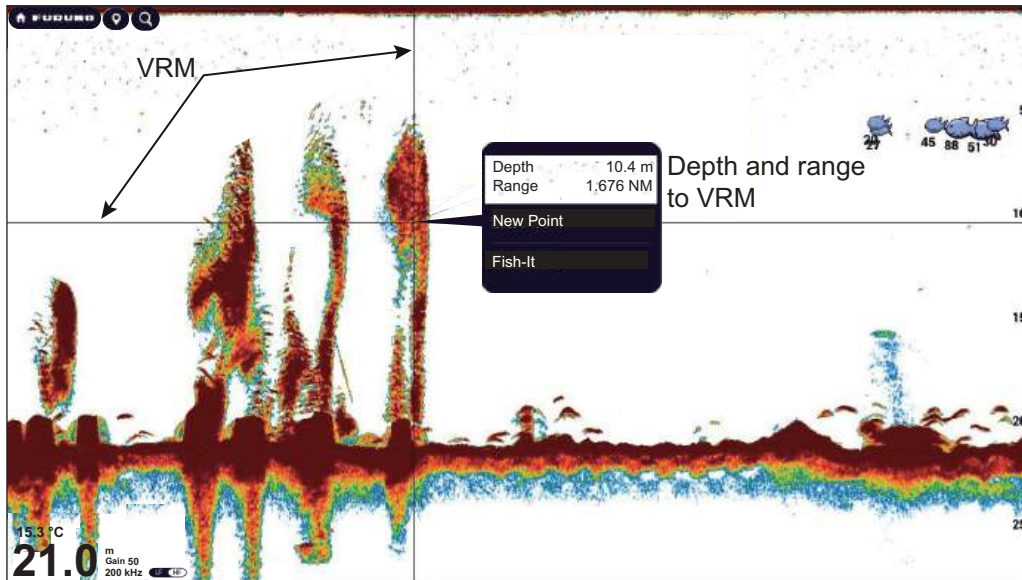

6.12 Echo History Display

You can view past echoes that are off the screen. Swipe the screen to the right to display past echoes. To return to the active display, tap [Cancel Hist] at the top right-hand corner of the screen.

6.13 How to Balance Echo Strength

Depending on local ultrasound characteristics, the reflection from a school of fish in deep water may appear in weaker colors than that from a school in shallow water even though their strengths are equal. To show the schools of fish in equal strengths (colors), use the TVG (Time Varied Gain). The gain level is automatically adjusted according to set water depth*, and TVG level, so that echoes of the same strength are displayed in the same colors.

* DFF-3D, DFF3-UHD, DFF1UHD+, TZT10X/13X/16X, TZT9E/13E, TZMAP9/13.

Note: This function is not available in the auto mode.

The figure shows an example display with proper TVG setting.

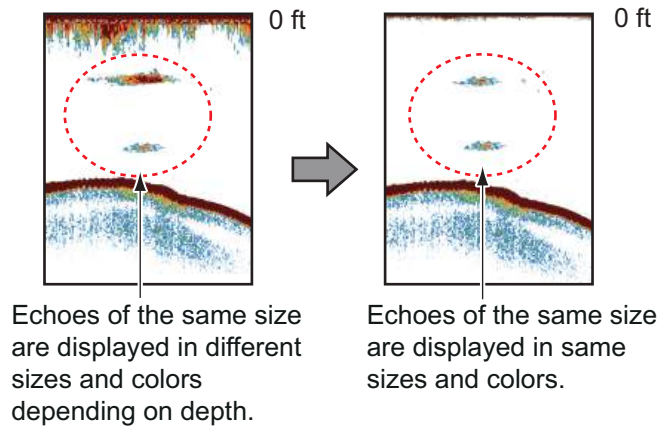

1. Home page → [Settings] → [Fish Finder] → [User Settings].
2. Tap [TVG Distance xx], and the software keyboard appears. The TVG's function changes according to the fish finder model used, as shown in the table below.
*: xx=transducer frequency indication, which changes according to transducer used.
3. Enter TVG value, then tap [✓].
4. Use the slider thumb (or software keyboard) for [xx* TVG] to set the TVG distance level. The TVG's function changes according to the fish finder model used, as shown in the table below.

Fish finder	TVG setting method
DFF1, DFF1-UHD, BBDS1, DFF-3D (version 1.04 or earlier)	The higher the setting, the greater the sensitivity at close ranges.
Network-installed NavNet TZtouch3 or NavNet TZtouchXL (TZT10X/13X/16X), TZT9E/13E, TZMAP9/13, or network sounder DFF3, DFF-3D (version 1.05 or later), DFF3-UHD, DFF1UHD+.	The higher the setting, the lower the sensitivity at close ranges.

5. Tap [x] on the title bar to finish and close the menu.

The TVG can also be set from the Layers menu, in the [Fish Finder] tab.

6.14 Fish Finder Alarms

Two types of fish alarms release audio and visual alarms to tell you that echoes from fish are in the area you selected.

The [Fish Alarm] function tells you when an echo above some strength (selectable) is within the alarm range you specify.

The [Fish Alarm for Bottom Lock] function tells you when fish are within some distance from the bottom. The bottom lock display must be active to use this alarm.

6.14.1 How to set an alarm

1. Home page→[Settings]→[Fish Finder]→[Fish Finder Alarms].
The [Fish Finder Alarms] menu can also be accessed by opening the [Overlays] tab of the Layers menu and tapping the setting icon () that appears to the left of [Fish Alarm].
2. **[Fish Alarm]:** Tap [Range Minimum Value] or [Range Maximum Value] below [Fish Alarm] to display the software keyboard.
[Fish Alarm for Bottom Lock]: Tap [Range Minimum Value] or [Range Maximum Value] below [Fish Alarm for Bottom Lock] to display the software keyboard.

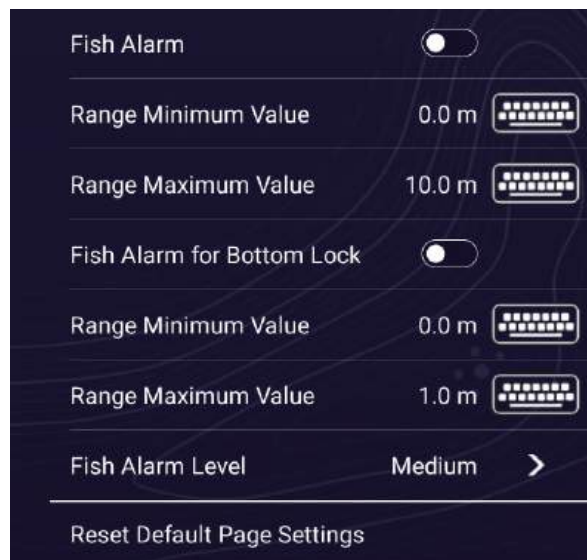

3. Set the start depth in [Range Minimum Value], the end depth in [Range Maximum Value].

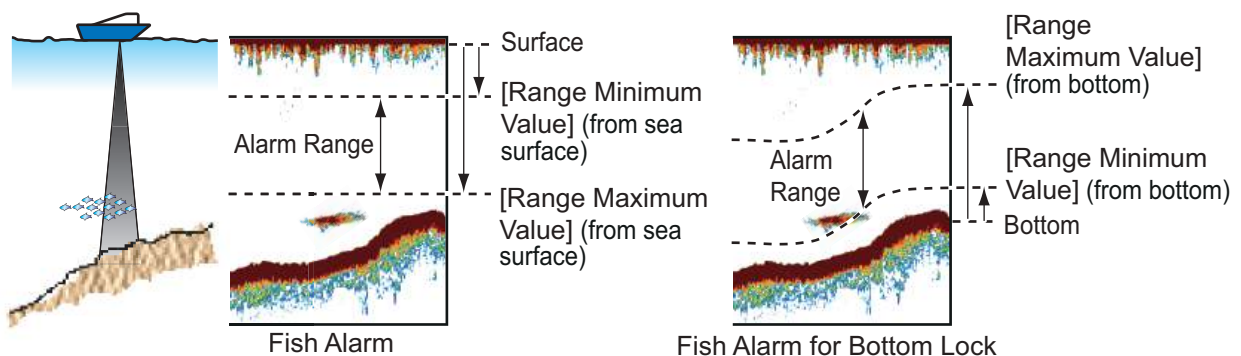

4. Tap [x] on the title bar to finish and close the menu.

6.14.2 How to activate or deactivate an alarm

Fish alarm

1. Home page→[Settings]→[Fish Finder]→[Fish Finder Alarms].
2. Turn [Fish Alarm] on or off.
3. Tap [×] on the title bar to finish and close the menu.

The fish alarm can also be activated or deactivated with [Fish Alarm] in the Layers menu ([Overlays] tab).

Bottom lock fish alarm

1. Home page→[Settings]→[Fish Finder]→[Fish Finder Alarms].
2. Turn [Fish Alarm for Bottom Lock] on or off.
3. Tap [×] on the title bar to finish and close the menu.

6.14.3 Alarm sensitivity

You can select the echo strength that releases the fish finder alarms.

1. Home page→[Settings]→[Fish Finder]→[Fish Finder Alarms].
2. Tap [Fish Alarm Level].
3. Tap the echo strength that releases the fish and bottom lock alarms. [Low] releases the alarm against weak-to-strong echoes.
4. Tap [×] on the title bar to finish and close the menu.

6.14.4 Reset the fish alarm menus to default

You can select the echo strength that releases the fish finder alarms.

1. Home page→[Settings]→[Fish Finder].
2. Tap [Fish Finder Alarms], then tap [Reset Default Page Settings]
3. Tap [OK].
4. Tap [×] on the title bar to finish and close the menu.

6.15 ACCU-FISH™

With connection of a ACCU-FISH™ compatible transducer to networked DFF series, TZT9E/13E, TZMAP9/13, BBDS1, NavNet TZtouch3, or NavNetTZtouchXL (TZT10X/13X/16X only), ACCU-FISH™ recognizes individual or multiple fish instantaneously and marks each with the ACCU-FISH icon. The size and depth value of a single fish can also be displayed on the image.





Usage guidelines

- The information provided by this feature is intended for reference only. The indicated fish length is only an estimate.
- ACCU-FISH™ is available for use on both the high and low frequencies.
- The intensity of an echo depends on fish species. If the indicated length is different from the true length, you can apply an offset. See subsection 6.15.2.
- Two frequencies are transmitted alternately without reference to the current display mode.
- This feature works where the depth is between 2 and 100 m.
- This feature cannot be used with the inside-hull transducer since a fish may not be detected depending on the frequency of the transducer. Even if a fish is detected, the fish length indicated may be smaller than the actual length.
- ACCU-FISH™ uses both low and high frequency echoes for the measurements regardless of the frequency mode in use.
- Echoes from a school of fish can be in more than one layer, which can cause wrong length indication.
- The fish symbol indication is not shown when the bottom echo is not shown on the screen.
- The split range feature is inoperative when ACCU-FISH™ is on.

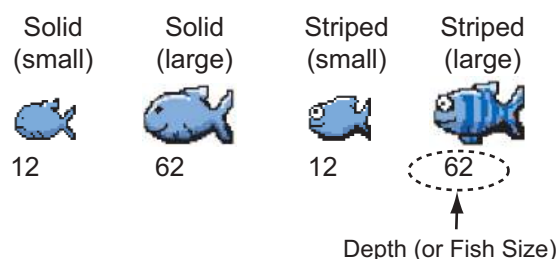
6.15.1 How to set ACCU-FISH™

1. Home page→[Settings]→[Fish Finder].
2. Tap [ACCU-FISH]→[ACCU-FISH Info].
3. Tap [Fish Size] or [Depth]. Tap [<] on the title bar to go back one layer in the menu.
[Fish Size]: Show length of fish.
[Depth]: Show depth of fish.
4. Tap [ACCU-FISH Symbols].
5. Tap [Solid], [Striped], [Circle] or [Off]. To erase the fish symbol (including circle), tap [Off].



Fish size	Solid	Striped	Circle
Large fish symbol (more than 51 cm (20.08 inch))			
Small fish symbol (10 to 50 cm (3.9. to 19.69 inch))			

6. Tap [x] on the title bar to finish and close the menu.

6.15.2 Fish size correction

The fish size shown on the screen can be different from the true size. If the size is wrong, add an offset to the measured value to get a more accurate indication on the screen.

1. Home page→[Settings]→[Fish Finder]→[ACCU-FISH]→[ACCU-FISH Size Correction].
2. Use the slider bar to set correction percentage (setting range: -80% to 100%).

Setting	Revised size	Setting	Revised size
+100	Two times	-65	1/3
+50	1.5 times	-75	1/4
-50	1/2	-80	1/5

3. Tap [×] on the title bar to finish and close the menu.

6.15.3 How to turn the fish symbol indication on or off

Tap the screen to open the Layers menu. Tap the [Overlays], tab, then turn [ACCU-FISH] on or off. Fish symbols and their depth values or fish lengths appear on the screen. If you selected [Off] at step 5 in subsection 6.15.1, the fish symbols are hidden and only the depth values or fish lengths appear.

Note: The ACCU-FISH symbol is always off on the weather display.

6.15.4 How to display the fish information

Tap a fish symbol to display the information (size, depth, bearing and range) about the fish.

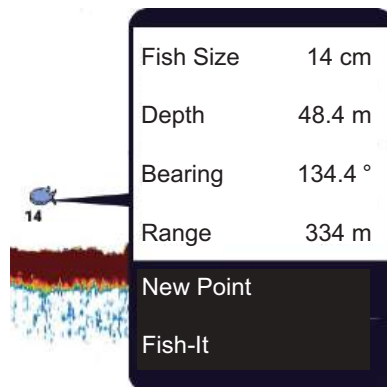

6.15.5 How to set the minimum size of ACCU-FISH™ symbols

If you are in an area where there are many fish, the screen may become congested with ACCU-FISH™ symbols. To prevent this, you can set the minimum size for the symbols.

1. Home page→[Settings]→[Fish Finder]→[ACCU-FISH]→[ACCU-FISH Minimum Size].
2. With the software keyboard, enter minimum size (0 to 79.98 (inch)), then tap ✓.
3. Tap [×] on the title bar to finish and close the menu.

6.16 RezBoost™ (TZT9E/13E Only)

RezBoost™, which requires a RezBoost™ compatible transducer connected to a network, raises echo resolution to help distinguish single fish from the bottom echo. In the example below, it is difficult to distinguish a single fish from the bottom in the standard fish finder mode. With RezBoost™, however, fish are clearly separated from the bottom echo.

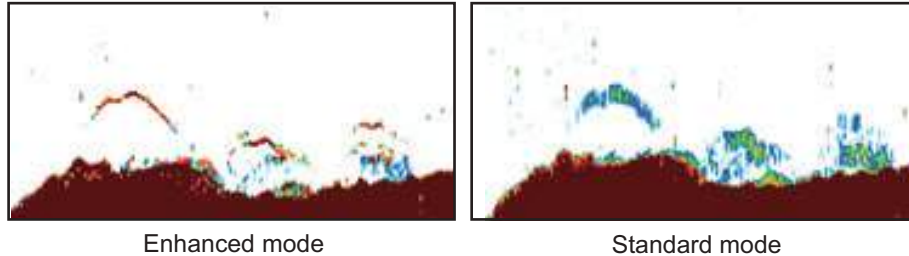

Note: RezBoost™ requires a network-installed [TZT2BB], [TZT9F], [TZT12F], [TZT16F], [TZT19F].

1. Open the Layers menu, then tap the [Overlays] tab.
2. Set [RezBoost] to [Enhanced].

To deactivate RezBoost™, select [Standard] at step 2 in the above procedure.

6.17 White Edge

The white edge function gives the seabed echo a white edge, making it easier to differentiate bottom-feeding fish from the seabed itself.

Note: The white edge function is compatible with BBDS1, DFF1, DFF1-UHD, DFF1UHD+, DFF3, DFF-3D, DFF3-UHD, NavNet TZtouch3 and NavNet TZtouchXL (TZT10X/13X/16X only), TZT9E/13E, TZMAP9/13 connected on the network. Operation is not guaranteed if you use any device or software version other than those listed below.

Equipment	Software version	Equipment	Software version
BBDS1	0252379-02.01 or later	DFF3	0252362-02.01 or later
DFF1	0252353-03.01 or later	DFF-3D	0252440-01.03 or later
DFF1-UHD	0252405-03.01 or later	DFF3-UHD	0252480-01.02 or later
DFF1UHD+	0252495-25.21 or later		

To activate the white edge function, do the following:

1. Open the Layers menu, then tap the [Overlays] tab.
2. At [White Edge], tap the desired width for the white edge. The higher the number the greater the width.

To deactivate the white edge function, tap [Off] at step 2 in this procedure.

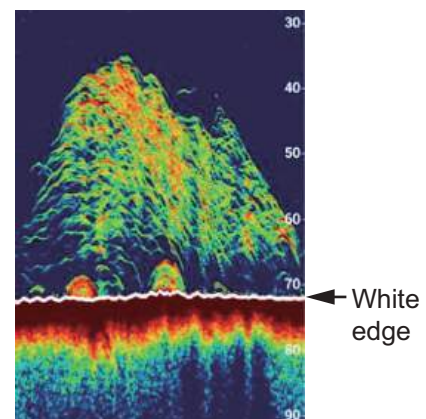

Note: With the DFF-3D's triple beam display, white edge is available only with the downward picture.

6.18 Water Temperature Graph

With connection of a water temperature sensor, you can plot sea surface temperature over time. Open the Layers menu, tap the [Overlays] tab, then turn on [Temperature Graph]. The sea surface temperature graph runs across the screen from right to left, the latest temperature at the right edge of the display. The temperature scale is at the left edge of the display. The unit of measurement ($^{\circ}\text{C}$ or $^{\circ}\text{F}$) can be selected with [Temperature] in the [Units] menu.

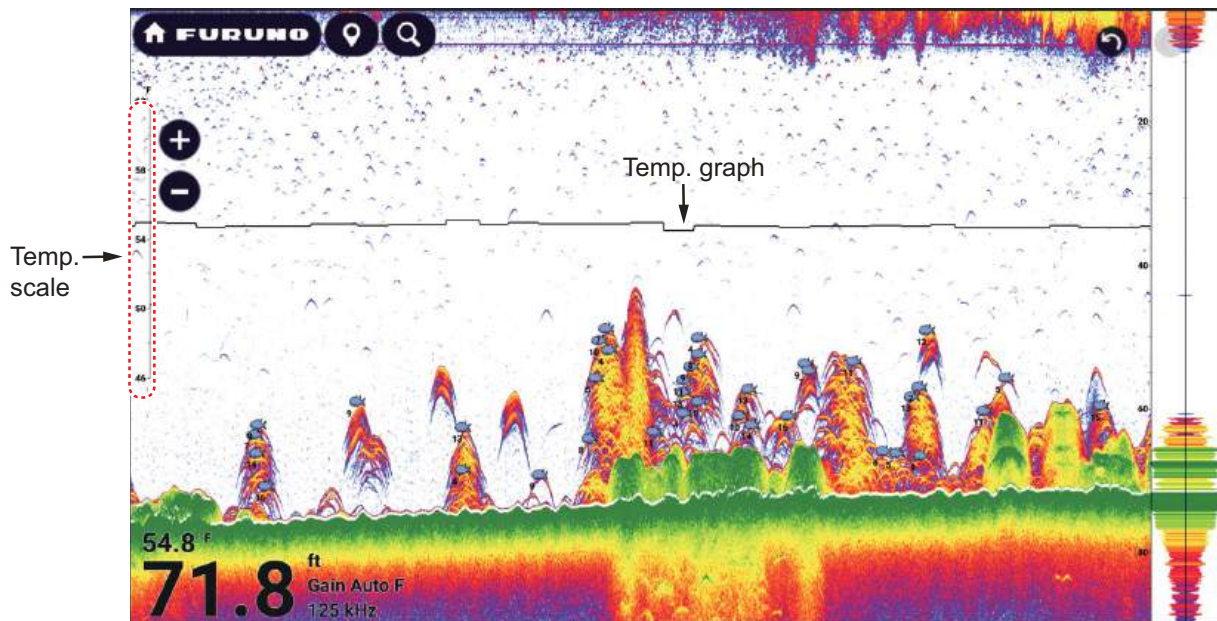

6.19 Preset Frequency

Three distinct frequencies can be preset in the following three cases.

- Network fish finder DFF3-UHD/DFF1UHD+ (DFF3-UHD program version: 0252480-02.04 or later, DFF1UH+ program version: 0252495-25.21 or later),
- Network-installed NavNet TZtouch3 with DI-FFAMP.
- NavNet TZtouch3 with CHIRP transducer, NavNet TZtouchXL (TZT10X/13X/16X), TZT9E/13E, or TZMAP9/13.

Note 1: The present frequency function is only available when the transducer is selected by model or TDID ([Fish Finder]→[Fish Finder Initial Setup]→[Transducer Setup]→[Transducer Setup Type]→[Model] or [TDID]). See the Installation Manual for details.

Note 2: When the DFF3-UHD is connected and selected as a fish finder source, the [Preset Frequency Setup] menu cannot be displayed simultaneously on multiple displays. (If displayed at the same time, the menu will not be displayed normally.)

1. Home page→[Settings]→[Fish Finder]→[Fish Finder Initial Setup].
2. Tap [Preset Frequency Setup].

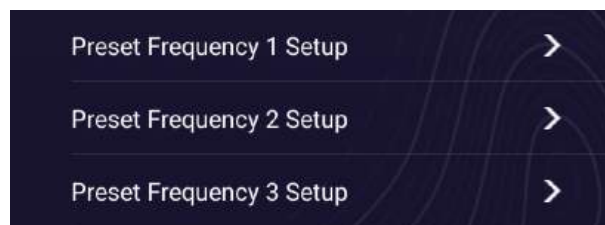

3. Tap [Preset Frequency 1 Setup] (or 2, 3).

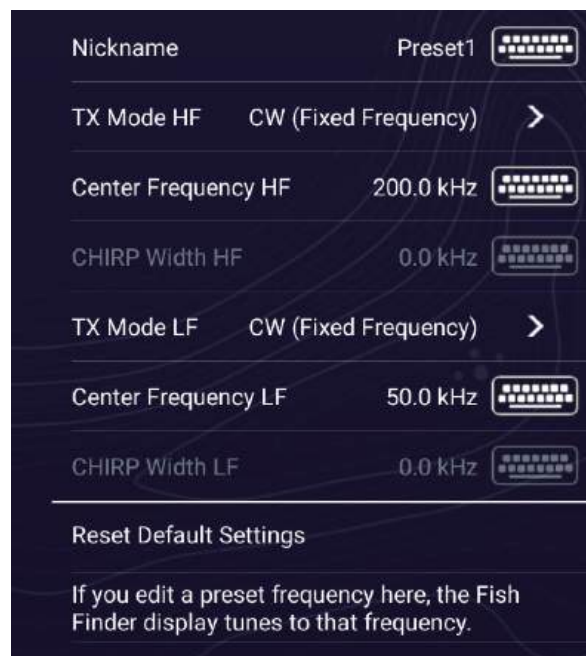

Note: [Reset Default Settings] is inoperative.

4. Tap [Nickname]. The software keyboard appears.
5. Change the nickname, then tap [✓].

6. FISH FINDER

6. Tap [TX Mode HF] or [TX Mode LF].
7. Select [Auto], [FM (Manual CHIRP)], or [CW (Fixed Frequency)] as appropriate. [Auto] automatically adjusts CHIRP center frequency and frequency bandwidth according to the depth. For [Auto], go to step 12. For [FM (Manual CHIRP)] or [CW (Fixed Frequency)] go to step 8.
8. Tap [Center Frequency HF] or [Center Frequency LF] to show the software keyboard.
9. Set the center frequency, then tap [✓]. For [FM (Manual CHIRP)] go to step 10. For [CW (Fixed Frequency)] go to step 12.
10. Tap [CHIRP Width HF] or [CHIRP Width LF] to show the software keyboard.
11. Set the CHIRP frequency bandwidth, then tap [✓].
Note: A new frequency is applied after changing it and returning to the fish finder display.
12. Tap [×] on the title bar to finish and close the menu.

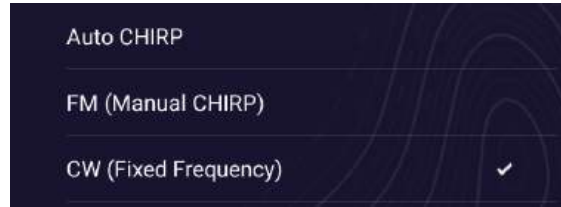

You can switch the frequencies from the Layers menu. Tap the [Fish Finder] tab, then tap [Preset 0] (1 or 2) at [Preset Frequencies].

For other, related menu settings, see section 6.21.

6.20 Color Range Expansion

The [Color Range Expansion] feature allows you to extend the range of signal intensities that can be identified by echo color. To activate this feature, Home page→[Settings]→[Fish Finder]→[User Settings]→turn on [Color Range Expansion]. With [Color Range Expansion] turned off, the range of identifiable signal intensities is narrow and only small fish are assigned colors. Echoes with intensities greater than large fish are colored brown (strongest color), making it difficult to distinguish large fish from the bottom. When [Color Range Expansion] is turned on, the range of identifiable signal intensities is expanded, and the resolution is higher.

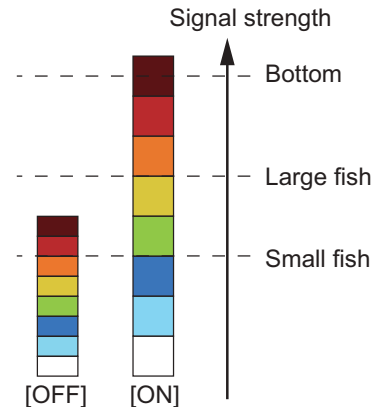

Note 1: Set the fish finder source to DFF3-UHD, DFF1UHD+, network-installed NavNet TZtouch3, TZMAP9/13, TZT9E/13E, or NavNet TZtouchXL (TZT10X13X/16X).

Note 2: It is recommended to turn off [Color Range Expansion] when fishing in deep waters where the bottom echo is shown in weak colors. This is because the intensity of the reflected wave becomes weaker overall as the depth increases. Namely, the color of echoes is lighter overall and the bottom echo is not shown in brown (strongest color).

Note 3: When this function is active, the reflection from a school of fish becomes weaker in deep waters where the bottom echo is shown in weak colors. This may prevent proper detection of fish by the [Fish Alarm] and [Fish Alarm for Bottom Alarm].

6.21 Fish Finder Menu

This section describes the [Fish Finder] menu items not described in previous sections. To show the [Fish Finder] menu, open the Home page, then tap [Settings]→[Fish Finder].

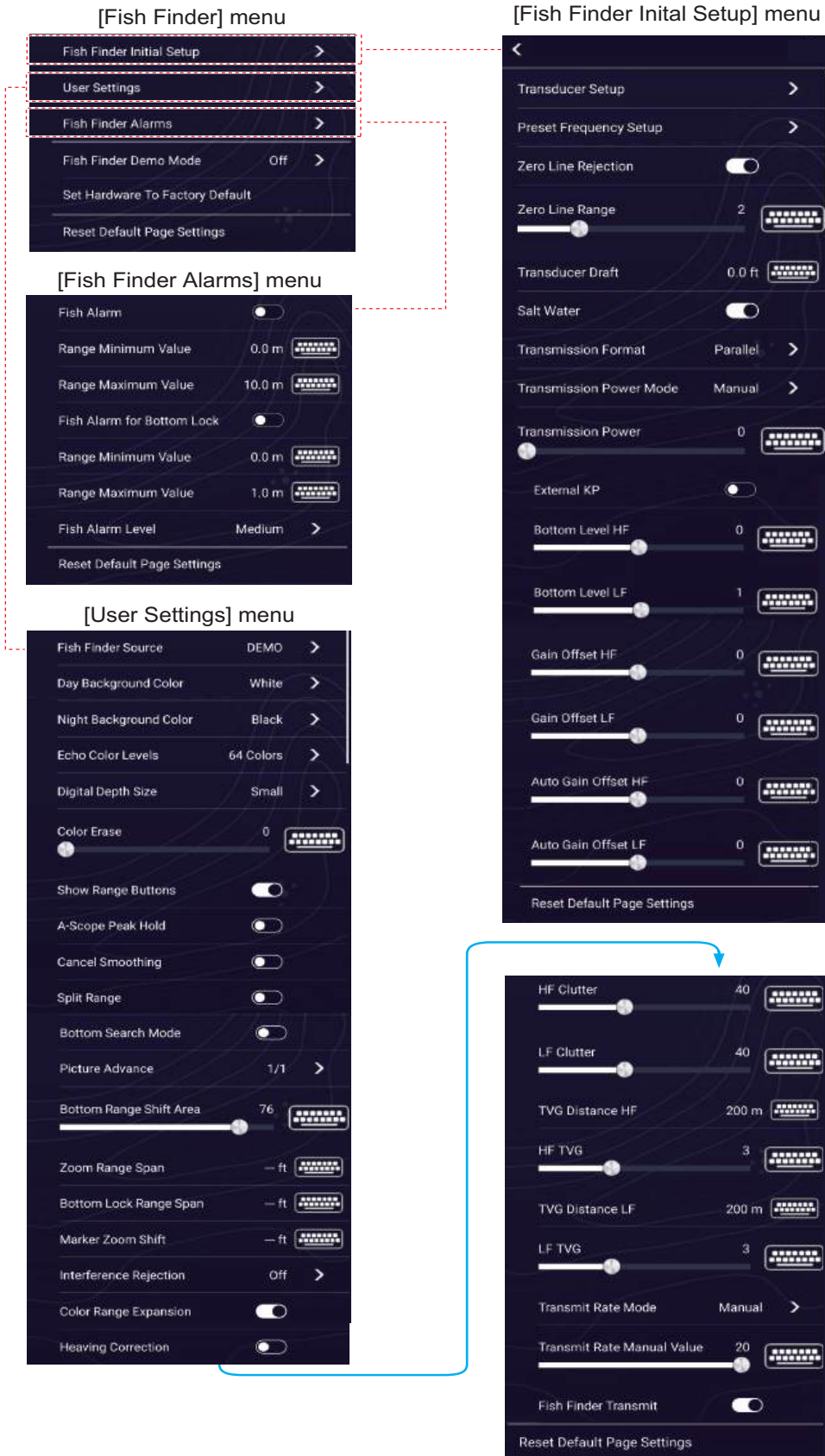

[Fish Finder Initial Setup] menu

[Transducer Setup]: Select the method to setup the transducer, by model, manually, or automatic TDID (transducer ID). See the installation manual for details.

[Zero Line Rejection]: When turned on, the zero line rejection function works to remove fish reflections near the surface. The length of the zero line tail varies depending on the type of transducer and installation conditions. If you are using a transducer with an oscillation line of 1.4 m or more, set [Zero Line Range] to higher than 1.4.

Note: When any of the models listed below are set for the TZMAP9/13, or for [Fish Finder Source], and this menu item is set to ON, set the [Zero Line Range] as shown below.

- DFF3
- TZTXFF (built-in fish finder of TZT10X/13X/16X)
- TZTEFF (TZT9E/13E)
- DFF1UHD+
- DFF3-UHD
- DI-FFAMP (TZT12F/16F/19F)

[Zero Line Range]: When [Zero Line Rejection] is on, you can set the removal range for the zero line. Available when DFF3, DFF3-UHD, DFF1UHD+, TZTXFF (built-in fish finder of TZT10X/13X/16X), TZTEFF (TZT9E/13E), TZMAP9/13, or DI-FFAMP (TZT12F/16F/19F) is selected for the TZMAP9/13, or for fish finder source. The setting range is 1.4 to 2.5 for DFF3, and 1.4 to 3.8 for TZMAP9/13, DFF3-UHD/DFF1UHD+/TZTXFF/DI-FFAMP/TZTEFF. If the zero line trail is long, set the value to a larger number. If the line still does not disappear, reduce the transmission power.

[Transducer Draft]: Set the distance between the transducer and the draft line to show the distance from the sea surface (Setting range: 0.0 to 99.9 m).

[Salt Water]: Turn on to use this equipment in salt water.

[Transmission Format]: Select whether to transmit high and low frequencies simultaneously or with a time difference. Requires DI-FFAMP (TZT12F/16F/19F), DFF3-UHD*. The settings are [Parallel] and [Sequential]. If interference occurs with the [Parallel] setting, switch to [Sequential].

*: The settings are [Parallel], [Sequential A], [Sequential B]. Available with program no. 0252480-02.04 or later.

[Transmission Power Mode]: If a fish finder of the same frequency is being used nearby, interference noise may appear on the screen. By communicating with other users and adjusting the transmit power, interference noise can be reduced. The setting range depends on the unit as follows:

- TZTEFF (TZT9E/13E with built-in fish finder), TZMAP9/13, TZTXFF (with built-in fish finder TZT10X/13X/16X), DFF1UHD+, or TZT9F/12F/16F/19F without DI-FFAMP, the settings are [Min], [Max].
- DFF3-UHD: [Auto], [Man] (0 (TX off) to 10 (max)).
- When a DI-FFAMP (TZT12F/16F/19F) is connected and a CHIRP transducer is selected: [Auto], [Man] (1 (TX off) to 10 (max)).
- DFF1-UHD: [Off], [Min], [Auto]
- DFF1, BBDS1, DFF3: 0 (off) to 10 (max)

[External KP]: Suppresses interference from other fish finder equipment on your own ship (see the fish finder's installation manual for details). Valid for other than DFF1, BBDS1, or TZTEFF selected for the [Fish Finder Source], and other than TZMAP9/13.

[Bottom Level (HF) / (MF) / (LF)]: The default bottom level setting (0) determines that two strong echoes received in sequence are bottom echoes. If the depth indication is not stable in the default setting, adjust the bottom level here. The setting range is -40 to 40. If vertical bars appear on the bottom line in the bottom expansion display, lower the bottom level until the vertical bars disappear. Be careful not to lower the level excessively; bottom fish may be judged as the bottom echo.

[Gain Offset (HF) / (MF) / (LF)]: If the gain setting is wrong, or there is a difference in the gain between the low and high frequencies, you can balance the gain for the two frequencies here.

[Auto Gain Offset (HF) / (MF) / (LF)]: If the auto gain offset is wrong, or there is a difference in the gain between the low and high frequencies, set an offset here to balance auto gain for the two frequencies.

[STC (HF) / (MF) / (LF)]: Delete unnecessary echoes (plankton, air bubbles, etc.) near the surface that hide the fish near the surface. The setting range is 0 to 10, and 0 is off. 10 deletes unnecessary echoes from the surface to approximately 16 ft. Make sure you do not use more STC than necessary, because small echoes near the surface may be erased. Available with DFF3, DFF1-UHD, DFF3-UHD, DI-FFAMP (TZT12F/16F/19F).

[TX Pulse (HF) / (MF) / (LF)]: The pulse width changes automatically depending on the range and shift settings. A shorter pulse width increases the resolution, and a longer pulse width increases the detection distance. If you want to increase the resolution on a magnified screen, set it to [Short 1] or [Short 2]. Available with DFF3, DFF3-UHD, or when a narrowband transducer is used with DI-FFAMP (TZT12F/16F/19F).

- **[Short1]**. Improves the detection resolution, but the detection range is shorter than with [Std] (pulse length is 1/4 of [Std])
- **[Short 2]**: Raises the detection resolution, however detection range is shorter (pulse length is about 1/2 of [Std]) than [[Std].
- **[Std]**: The standard pulse length, and is suitable for general use.
- **[Long]**: Increases the detection range but lowers the resolution (1/3 compared to [Std] pulse length.

[Rx Band (HF) / (MF) / (LF)]: The RX bandwidth is automatically set according to pulse length. To decrease noise, select [Narrow]. For better resolution, select [Wide]. Available with DFF3, DFF3-UHD.

[Temperature Port]: Select the data source for water temperature. Available with DFF3, DFF1-UHD. **[MJ Port]**: The water temperature data from the water temperature/speed sensor. **[Low Frequency]**: The low frequency measured water temperature. **[High Frequency]**: The high frequency measured water temperature.

[Reset Default Page Settings]: Resets the initial settings for the [Fish Finder Initial Setup] menu to default.

[User Settings] menu

[Fish Finder Source]: Select the fish finder to use (for the TZT9E/13E only).

[Day Background Color]: Select the background color for use during daylight hours. The options are [White], [Light Blue], [Black], [Dark Blue], [Blue], and [Sunlight].

[Night Background Color]: Select the background color for use at nighttime. The options are [Black], [Dark Blue], and [Blue].

6. FISH FINDER

[Echo Color Levels]: Select the number of echo display colors, among 8 colors, 16 colors, 64 colors.

[Digital Depth Size]: For full screen, select the display size of the depth, water temperature, gain, frequency, and frequency switching icon that appears at the bottom left-hand corner of the screen (small, medium, large).

Note: For split-screen, the display size can be selected in [General]→[This Display]→[Scale & Layout] menu.

[Cancel Smoothing]: When echoes appear “jagged,” turn off to smooth echoes.

[Bottom Search Mode]: This function eliminates the timing of acquiring echoes from the bottom, in order to improve the fish finder performance in the water layer. When turned on, transmission is turned off once every three transmissions to check the water depth and eliminate false echoes. When this feature is turned off, transmission is not turned off, so the transmission cycle is 1.5 times faster. This is convenient for off-shore lure fishing. You can also set this item from the Layers menu, in the [Overlays] tab. Turning OFF the bottom search mode can assist with turbulence issues to prevent automatic range from overreacting.

[Bottom Range Shift Area]: Select the area where to show the bottom echo, when [Auto Range] is active. For example, setting [75] would place the bottom echo at a position equivalent to 75% from the top of the screen.

[Heaving Correction]: Activates, deactivates heaving correction. Activate in high seas to stabilize the picture:

Note: [Heaving Correction] requires connection of a Satellite Compass™ and set up of the motion sensor (see section 3.5 of the Installation Manual). This function is inoperative without a Satellite Compass™.

[Echo Stretch]: Turn echo stretch on or off. The reflections from distant echoes are shown smaller than actual size because of signal attenuation. To enlarge distant targets, turn echo stretch on. Requires DFF3-UHD, program version no. 0252480-02.04 or later.

[Transmit Rate Mode]: Select the transmission rate selection method. [Auto] sets the rate according to ship's speed. Select [Manual] to set the rate manually.

Note: The built-in fish finder of the TZMAP9/13, TZTE9E/13E, TZT10X/13X/16X, and the DFF1UHD+ does not have the [Auto] setting. Additionally, this menu item is not shown when the fish finder source is DFF3-UHD.

[Transmit Rate Manual]: Change the TX pulse repetition rate in 21 levels (20 is the highest power.). Use 20 in normal use. Lower the TX rate in shallow waters to prevent the second reflection echo.

[Fish Finder Transmit]: Turn fish finder transmission on or off.

[Reset Default Page Settings]: Resets the items of the [User Settings] menu.

[Fish Finder] menu

[Finder Demo Mode]: Activates, deactivates the fish finder demo mode, which provides a fish finder display using data stored in the memory. Available with BBDS1, DFF1, DFF3, DFF1UHD+, built-in fish finder of TZMAP9/13*, TZTEFF (built-in fish finder of TZT9E/13E*), TZTXFF (built-in fish finder of TZT10X/13X/16X*), TZT9F/12F/16F/19F**. Not available with DFF1-UHD, DFF3-UHD.

[Off]: Deactivates the fish finder demo mode.

[Shallow]: Shallow waters demo mode

[Deep]: Deep waters demo mode.

*: DFF1UHD+, built-in fish finder of TZTXFF, TZTEFF, built-in fish finder of TZMAP9/13; [Off], [Demo 1] (DFF1UHD+ only), [Demo 2].

** : Built-in fish finder of TZT10X/13X/16; [Off], [Demo 1] to [Demo 4].

Note: This menu is for use by dealers. Users should not use this menu. Improper setting may cause loss of user settings.

[Set Hardware to Factory Default]: Reset the hardware settings for [Fish Finder Source] to default.

[Reset Default Page Settings]: Reset the [Fish Finder] menu settings to default.

6.22 How to Interpret the Display

Zero line

The zero line (transmission line) shows the position of the transducer. The line disappears from the screen when the range is shifted.

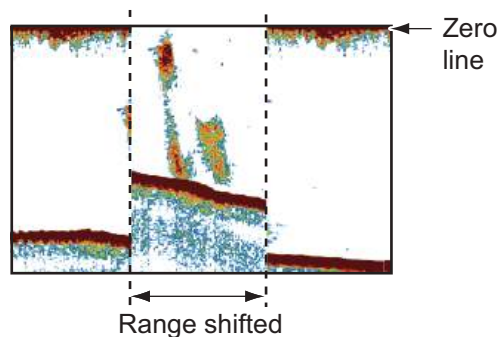

Bottom echoes

The strongest echoes are from the bottom, and are normally shown in reddish-brown or red. The colors and the width change with bottom material, depth, sea condition, installation, frequency, pulse length and sensitivity.

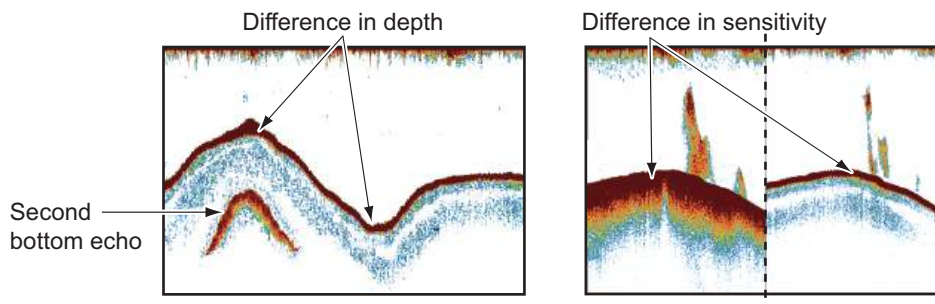

Bottom contour

The tail from a hard bottom is longer than the tail from a soft bottom, because the hard bottom reflects more of the ultrasonic pulse. An echo from shallow water gives a stronger reflection than the echo received from deep water. A longer bottom tail appears on slopes, because of the difference in travel time at both edges of the beam angle. For the rough bottom, echoes are reflected on many different planes, which displays echoes in many layers, giving a 3D effect.

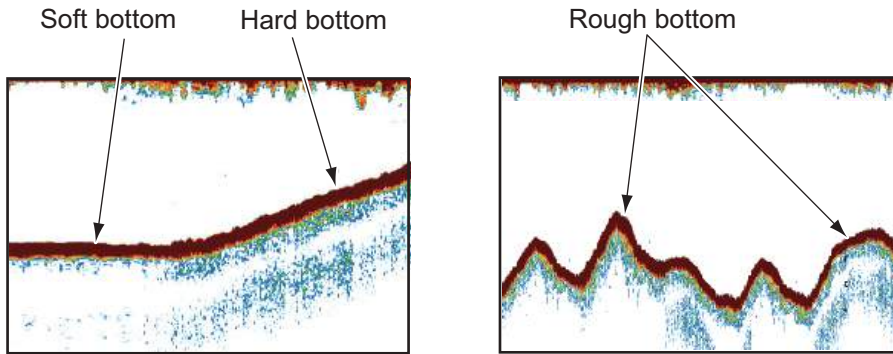

Nature of a bottom

The nature of a bottom is known from the intensity and length of the bottom tail. To find the nature of a bottom, use a long pulse length and normal gain. For the hard and rough bottom, the bottom echo is reddish-brown with a long tail. For the mud or sand bottom, the bottom echo has less red and with a short tail. A bottom with a lot of small particles can give a long tail on the low frequency picture.

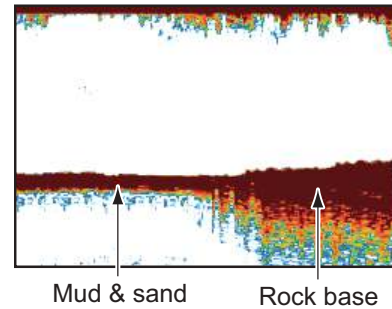

Fish volume

The size and density of a school of fish are indicators of the quantity of fish.

Size of a school of fish

Usually the size of fish echoes on the screen is proportional to the actual size of the school of fish. However, if two fish echoes appear at different depths with the same size, the school of fish at the shallower depth is larger because the ultrasonic beam widens as it propagates and a school of fish in deep water is displayed larger.

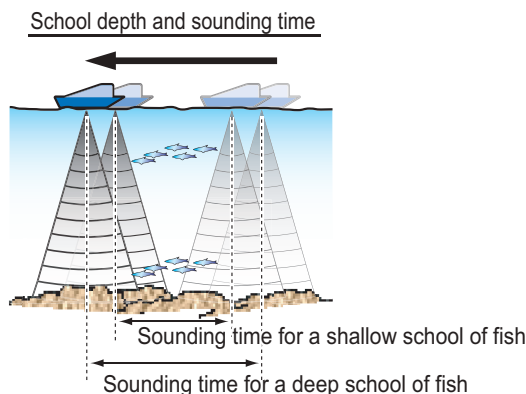
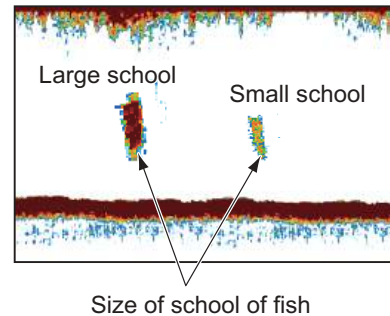

Density of a school of fish

If two schools appear with the same color at different depths, the one in deeper water is denser because the ultrasonic wave attenuates as it propagates and the school of fish in deep water tends to be displayed in a weaker color.

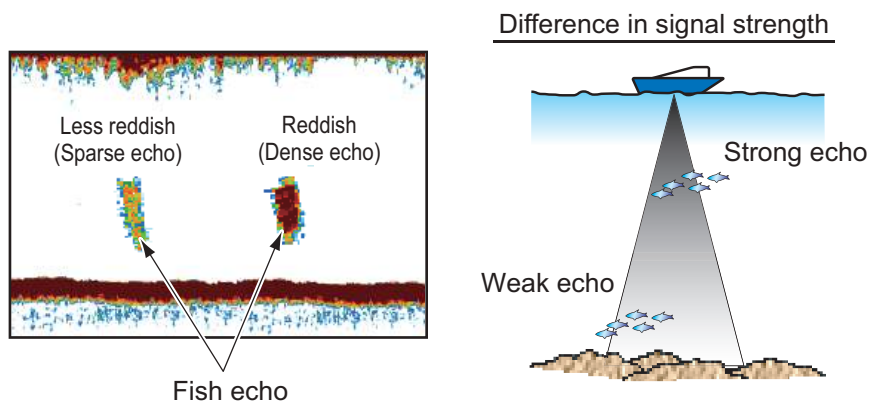

Bottom fish

The echoes from the bottom are stronger than the bottom fish echoes so that you can distinguish between them by colors. The bottom echoes are normally shown in reddish-brown or red, the bottom fish echoes in weaker color.

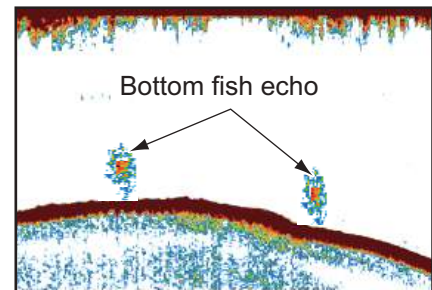

Plankton

Plankton, seen on the screen as a mass of green or blue dots, appears between the transmission line and the seabed. Plankton move down in the day and up at night. Because fish feed of the plankton, you can observe schools of fish within the plankton layer.

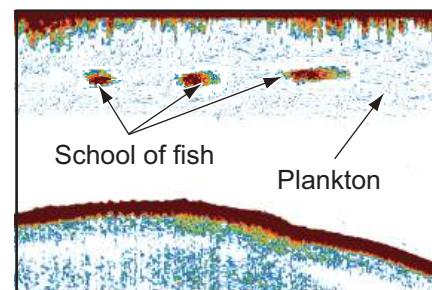

Current rip

When two ocean currents of different speeds directions and water temperatures meet, a current rip occurs. A current rip appears on the screen as shown in the right illustration.

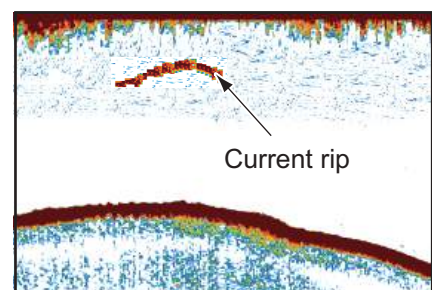

Surface noise

When the sea is rough or the ship moves over a wake, surface noise can appear at the top of the screen.

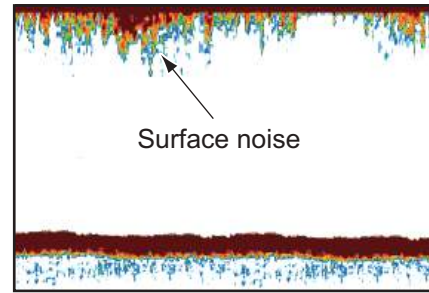

Air bubbles in the water

When the sea is rough or the ship makes a quick turn, there can be blank spots in the bottom echo (see the right illustration). These blank spots are caused by air bubbles that stop the movement of the sound wave. These air bubbles can occur with the low frequency ultrasonic waves.

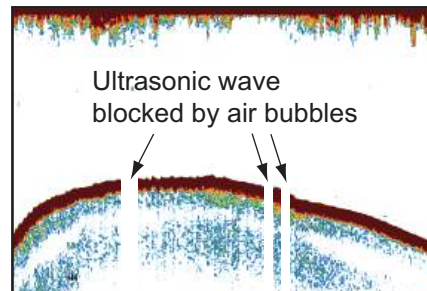

Unstable bottom echo

The bottom echoes can have a saw-tooth appearance. This occurs in heavy weather because pitching and rolling changes the direction of the ultrasonic pulses and the vertical motion of the ship causes the distance to the bottom to change.

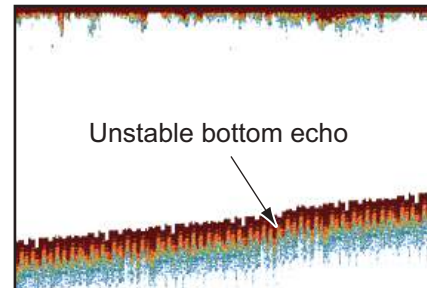

False echo

When an ultrasonic pulse is transmitted, some energy leaves from each side of the beam. This energy has the name "sidelobe". Echoes from sidelobes show on the screen as false images like in the illustration shown below.

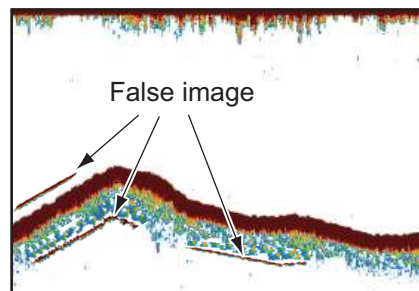
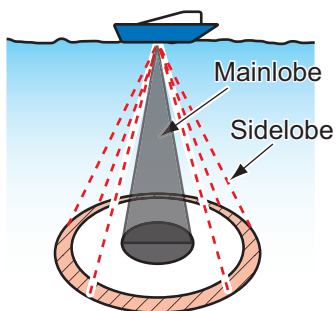

7. RADAR

This chapter provides the information necessary for radar operation, which requires a radar sensor.

Radar-related settings can be accessed in the two methods shown below. In this manual, the 1st method is used.

- Home page→[Settings]→[Radar].
- Layers menu→[Settings].

Note 1: The TZMAP9/13 is compatible with radome-type radars only; DRS2D-NXT, DRS4D-NXT, DRS4DL+, DRS4D X-Class, and DRS4DL X-Class. The TZT9E/13E is compatible with both radome-type and open-type radars.

Note 2: To change the radar source, Home page→[Settings]→[Radar]→[User Settings]→[Radar Source], then tap desired radar source. The source can also be selected from the Layers menu, with the [Radar] tab, [Radar Source].

7.1 Layers Menu

The radar Layers menu has three tabs: [Radar], [Overlays], and [User Objects].

- **[Radar]** tab: Enables, disables radar functions such as target analyzer, bird mode, rain and sea clutters adjustment, etc.
- **[Overlays]** tab: Shows or hides the overlay displays, such as AIS targets, ARPA targets, radar rings, guard zone.
- **[User Objects]** tab: Shows or hides user objects - routes, points, boundaries, echo trails.

7. RADAR

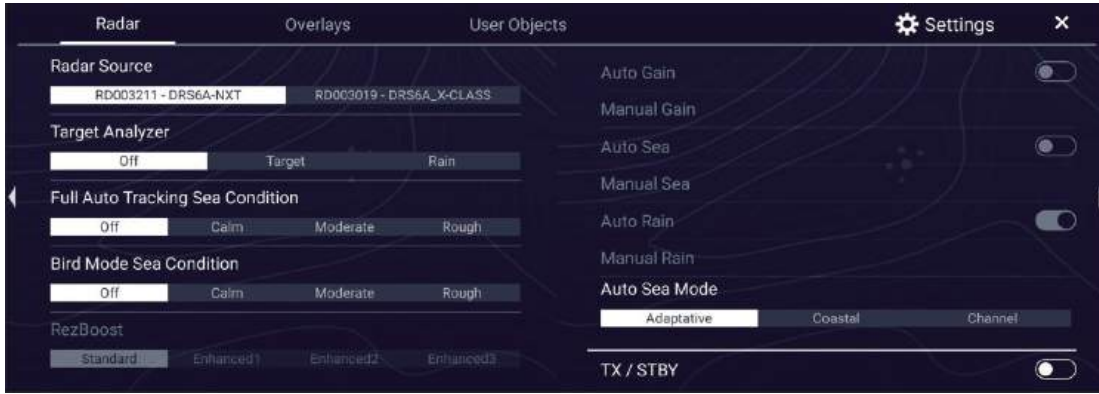

[Radar] tab

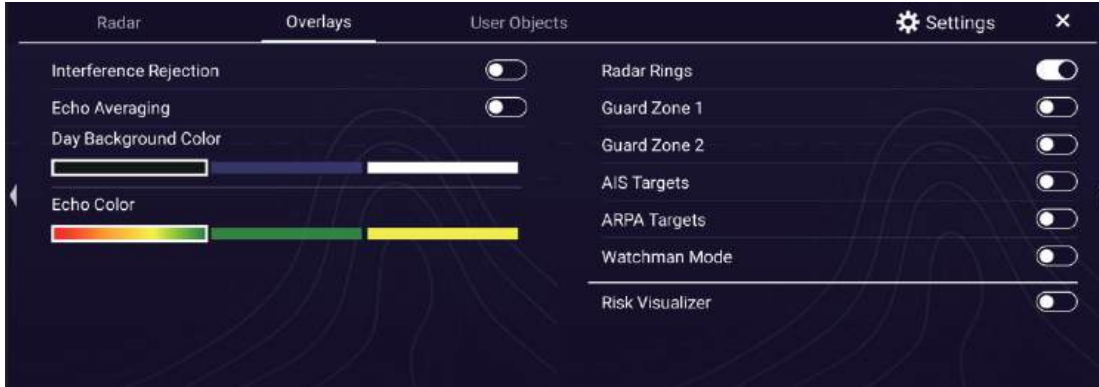

[Overlays] tab

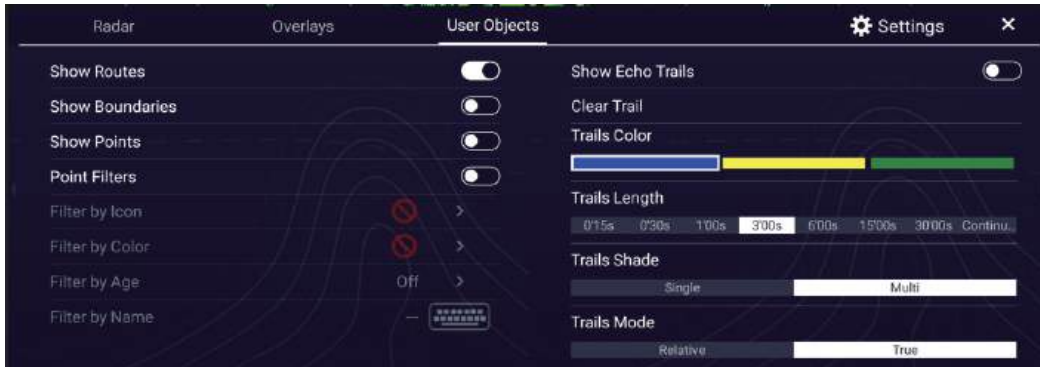

[User Objects] tab

7.2 How to Transmit, Set the Radar in Stand-by

Open the Home page, then tap the Radar icon. To start transmitting, tap the [TX] icon displayed on the bottom-left corner of the radar screen. Each tap of the icon alternates between transmit and stand-by. The icon is highlighted when the radar is in transmit state. You can also control transmit and stand-by from the Layers menu, with [STBY/ TX] in the [Radar] tab.

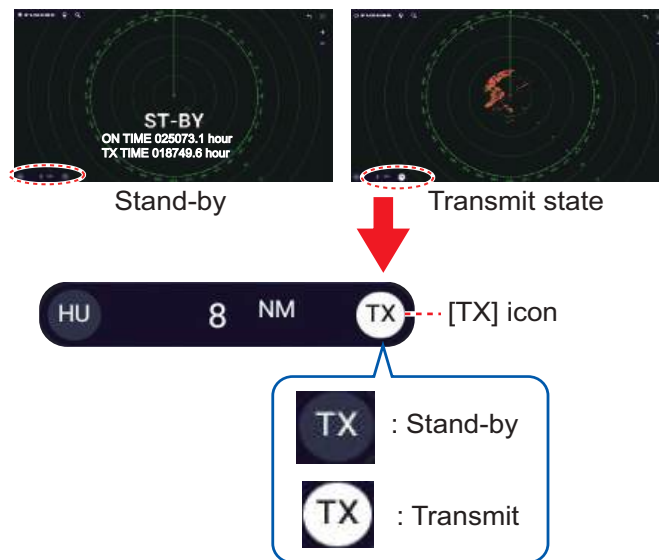

If you do not require the radar for some time, set the radar in stand-by to save it from unnecessary use.

TX channel selection (w/DRS-NXT series radar sensor)

In the default setting, the best TX channel is automatically selected at random among three channels. However, if interference is received from the radar of a nearby ship, open the [Radar] menu, tap [Radar Initial Setup], then set [TX Channel] to [1], [2] or [3], the channel number where the interference is smallest.

7.3 Tuning

By design the radar receiver is tuned automatically after the radar is set to transmit. To manually tune when a magnetron radar or DRS X-Class series is connected, do the following:

1. Home page→[Settings]→[Radar]→[Radar Initial Setup].
2. The default tuning method is automatic. Turn off [Auto Tuning] to enable manual tuning.
3. Use the slider bar for [Manual Tuning] to set the value.
4. Tap [×] on the title bar to finish and close the menu.



7.4 How to Adjust the Gain

You can adjust the gain (sensitivity) of the radar receiver. The correct setting shows some background noise on the screen. If you do not use enough gain, weak echoes are erased. If you use more gain than necessary, the background noise hides both weak and strong targets.

The gain can be adjusted from the Pop-up menu, slider bar (two finger tap function), Data window, and Layers menu.

Method 1: Pop-up menu

Automatic adjustment:

1. Tap the radar display to show the Pop-up menu, then tap [Radar Adjust].
2. Turn [Auto Gain] on.

Manual adjustment:

1. Tap the radar display to show the Pop-up menu, then tap [Radar Adjust].
2. Turn [Auto Gain] off.
3. Tap [Manual Gain].
4. With the slider bar at the right edge of the screen, drag the slider thumb, tap the slider bar, or tap the (+, -) buttons to adjust the gain.

5. Tap [Done] at the top of the screen to finish.

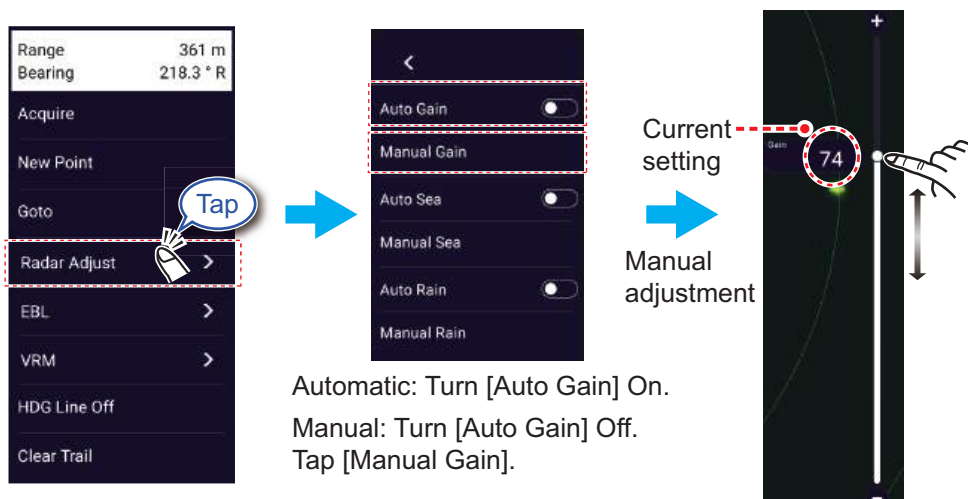

Method 2: Layers menu

Automatic adjustment:

1. Open the Layers menu.
2. Select the [Radar] tab, then turn [Auto Gain] on.

Manual adjustment:

1. Open the Layers menu.
2. Select the [Radar] tab, then turn [Auto Gain] off.
3. Tap [Manual Gain].
4. With the slider bar at the right edge of the screen, drag the slider thumb, tap the slider bar, or tap the (+, -) buttons to adjust the gain.
5. Tap [Done] at the top of the screen to finish.

Method 3: Two-finger (long) tap

Note 1: Set [Two Finger Tap Function] (or [Two Finger Long Tap Function]) to [Gain Control] in the [General]-[This Display] menu to use two-finger screen tap to adjust the gain. See section 1.16.

Note 2: To enable manual gain adjustment, tap the radar screen to show the Pop-up menu. Tap [Radar Adjust], then turn [Auto Gain] off.

Tap (long tap) the screen with two fingers to show the Gain slider bar. Use the slider bar referring to the illustration at the top of this page

Method 4: Radar Control data box in Data window

The gain can be adjusted from the Data window, with the [Radar Control] data box in the [RADAR] sheet.

1. Tap the [RADAR] tab at the top of the Data window.
2. Tap the [M/A] of [Gain]. [M] means manual; [A] means Automatic. Tap the flip-switch to switch between automatic and manual gain adjustment. For manual adjustment go the step 3.
3. Tap the numeric indication of [Gain].

7. RADAR

- With the slider bar at the right edge of the screen, drag the slider thumb, tap the slider bar, or tap the (+, -) buttons to adjust the gain.
- Tap [Done] at the top of the screen to finish.

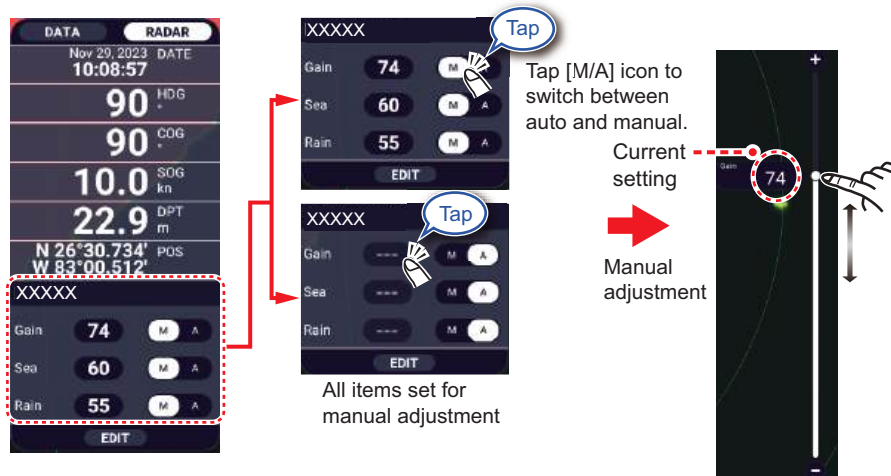

7.5 How to Reduce the Sea Clutter

The reflected echoes from waves appear at the central part of the screen and have the name "sea clutter". The sea clutter increases in width as the height of waves and the height of the antenna above the water increase. If the sea clutter is strong, targets can be hidden inside the clutter, like in the right-hand figure.

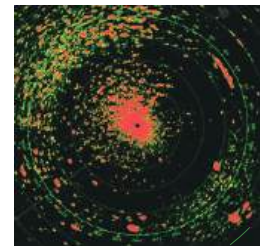

Sea clutter visible at the screen center

When the sea clutter hides targets, adjust the sea control (automatically or manually) to reduce the clutter. Like with gain, sea clutter can be adjusted from the Pop-up menu, slider bar, Data window, and Layers menu ([Radar] tab→[Auto Sea] or [Manual Sea]). See the procedures in section 7.4.

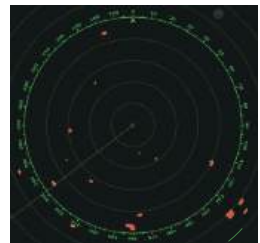

Sea control adjusted; sea clutter suppressed

For automatic sea clutter suppression, there are three methods: [Adaptive], [Coastal], and [Channel]*. [Adaptive] provides good overall clutter reduction, however some surface reflections may appear on-screen. [Coastal] provides strong clutter reduction based on echo strength, however some objects, such as small land masses, may also be removed. [Channel] provides low clutter reduction, appropriate for navigating channels.

To select an automatic sea clutter suppression method, open the Layers menu, tap the [Radar] tab, then tap [Adaptive], [Coastal], or [Channel] at [Auto Sea Mode].

*: Available with the following radars and software versions.

Radar sensor	Version
DRS4DL+	0359367-01.01 or later
DRS2D-NXT, DRS4D-NXT	0359360-01.11 or later
DRS6A-NXT, DRS12A-NXT, DRS25A-NXT	0359421-01.11 or later
DRS6A X-Class, DRS12A X-Class, DRS25A X-Class	0359355-02.06 or later
DRS4D X-Class	0359517-01.02 or later
DRS4DL X-Class	0359517-01.03 or later

7.6 How to Reduce the Rain Clutter

When your ship is in or near rain or snow, the reflections from rain or snow appear on the screen. These reflections have the name "rain clutter". When the rain clutter is strong, targets in or near the rain clutter are hidden in the clutter. Reflections from the rain clutter are easily identified from true targets by their wool-like appearance.

The rain control breaks the continuous display of rain or snow reflections into a random pattern. The rain control also helps to reduce the target clutter in good weather in busy harbors. When the rain clutter hides targets, adjust the rain control (automatic or manual) to reduce the clutter.

Like with gain, rain clutter can be adjusted from the Pop-up menu, Rain slider bar, Data window, and Layers menu ([Radar] tab→[Auto Rain] or [Manual Rain]). See the procedures in section 7.4.

7.7 Range Scale

The range setting controls the size of the area (in nautical miles, kilometers or statute miles) that appears on your screen. The range appears at the bottom left-hand corner of the screen.

How to zoom in or out the range scale

Method 1: Use the pinch operation.

Use two fingers and pinch on the radar screen to zoom in or out (see the right-hand figure).

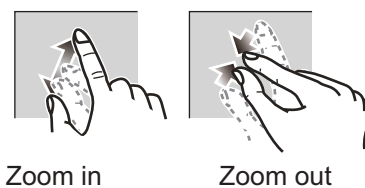

Method 2: Use the range buttons.

Tap the range icons (+/-) at the top right-hand corner. The +/- buttons can be shown or hidden ([Settings]→[Radar]→[User Settings]→[Show Range Buttons]).

Method 3: Use the range slider.

Drag the slider bar thumb (circle) shown on the right-hand side of the screen, tap the slider bar, or tap the range buttons (+, -). Set the range slider can be shown or hidden ([Settings] → [Radar]→[User Settings]→ [Show Range Slider]).

7.8 Orientation Mode

The orientation mode determines how you view the positional relationship between your ship and other targets and the state of movement. There are two orientation modes, head up and north up.

Head up: A display without azimuth stabilization in which the line that connects the center with the top of the screen indicates your heading. Targets are shown at their measured distances and in their directions relative to your heading.

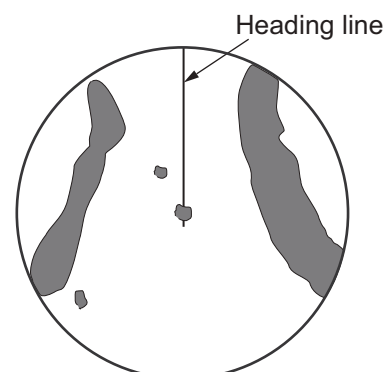

North up: Targets are shown at their measured distances and their true (compass) directions from your ship. North is at the top of the screen. The heading line changes its direction according to your heading.

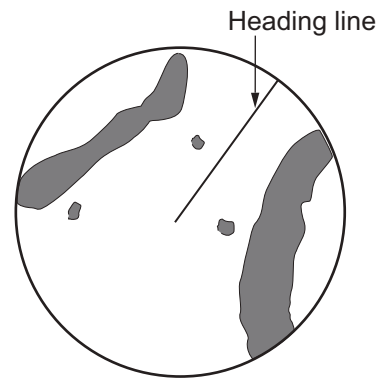

North up requires a heading signal. When the heading signal is lost, the radar automatically switches to the head up mode. To display the heading signal, reset the heading sensor. If necessary, reselect the display mode after the heading sensor is restored.

How to select an orientation mode

To select an orientation mode, tap the orientation mode icon [HU] (or [NU] whichever is shown) at the bottom right corner of the screen to show [HU] (Head-up) or [NU] (North-up).

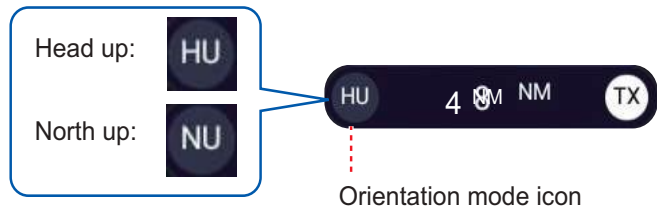

7.9 How to Measure the Range and Bearing from Your Ship to a Target

You can measure the range or bearing to a target by the following five methods.

	Range measurement	Bearing measurement
EBL (Electronic Bearing Line)	No	Yes
Fixed range rings	Yes	No
Ruler	Yes	Yes
Tap inside effective display	Yes	Yes
VRM (Variable Range Marker)	Yes	No

7.9.1 How to display the range rings

The range rings are the concentric solid circles about your ship. Use the fixed range rings to get a rough estimate of the range to a target.

To show or hide the range rings, open the Layers menu, tap the [Overlays] tab, then turn [Radar Rings] on or off.

To measure the range with the range rings, count the number of rings between the center of the screen and the target. Check the range ring interval and estimate the distance of the echo from the inner edge of the nearest ring.

7.9.2 How to set the number of the range rings to show

1. Home page→[Settings]→[Radar]→[User Settings].
2. Tap [Rings Interval].

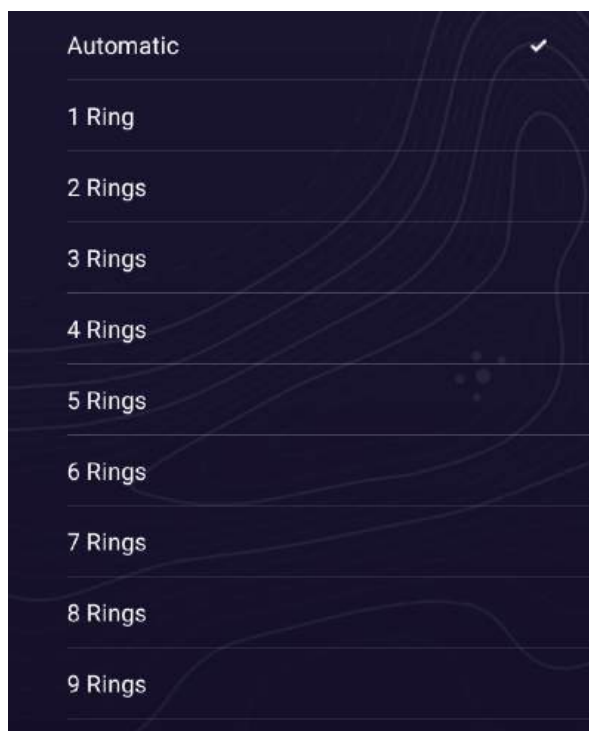

3. Tap a number. [Automatic] automatically selects the number of rings according to the range scale.
4. Tap [×] on the title bar to finish and close the menu.

7.9.3 How to select the range rings mode

To select the range rings mode, Home page→[Settings]→[Radar]→[Radar Initial Setup]→[Bearing Scale Mode]→[True] or [Relative].

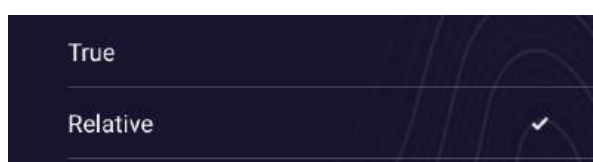

7. RADAR

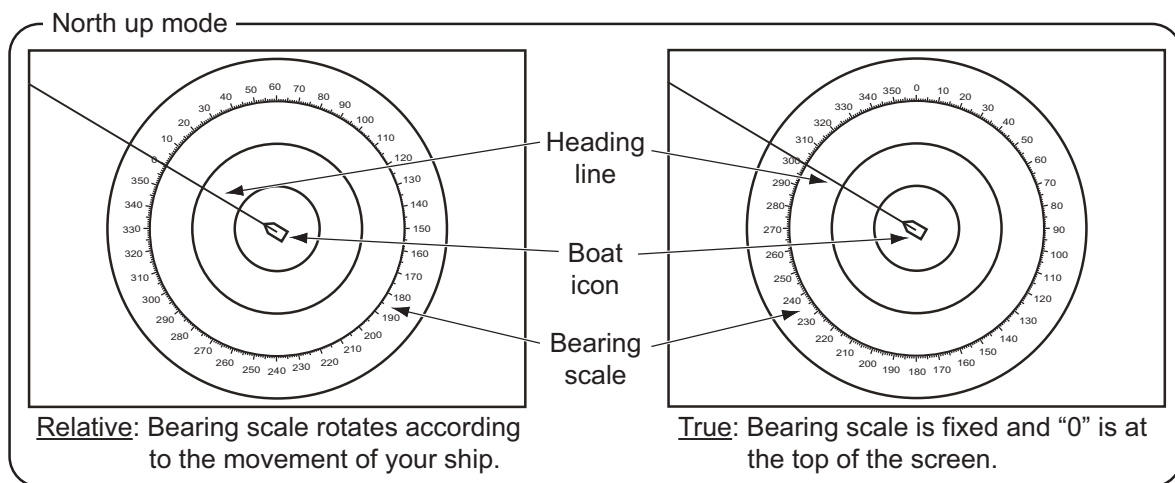
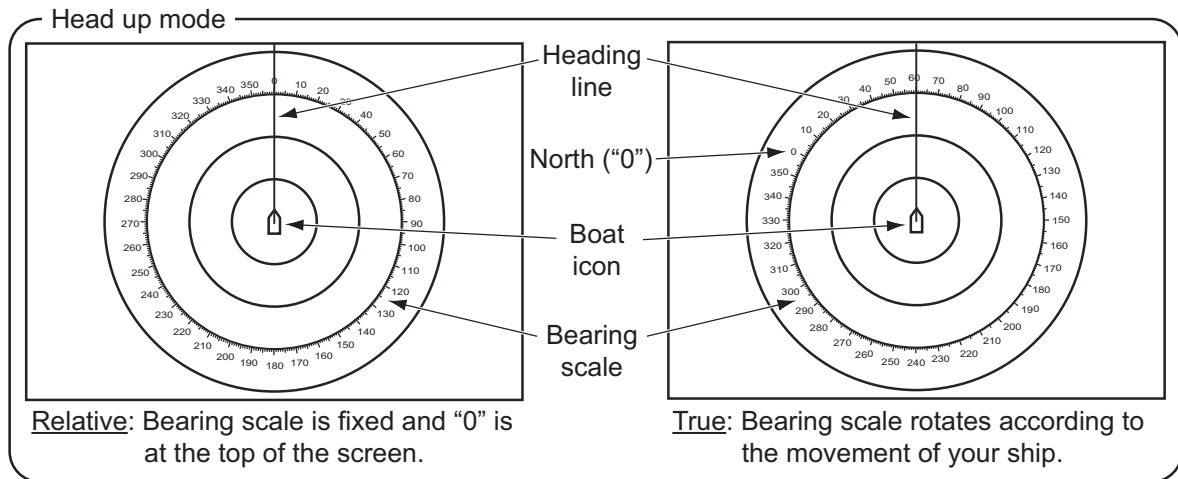

7.9.4 How to measure the range and bearing to an object

Tap an object to get its range and bearing from own ship. Read the range and bearing in the Pop-up menu.

Range and bearing to object

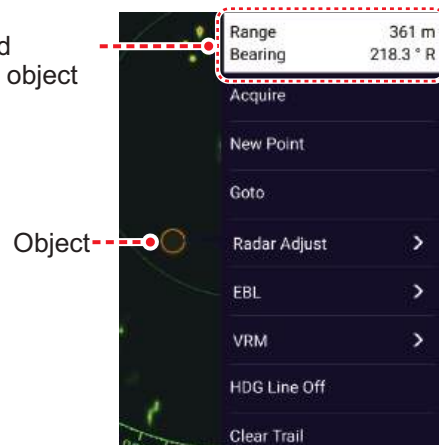

7.9.5 How to measure the range with the VRM

The VRM is a dashed ring so that you can identify the VRM from the fixed range rings.

Method 1: Using the EBL/VRM box in the Data window

1. Referring to section 1.9.3, add the [EBL/VRM] data box to the [RADAR] Data window.
2. Display the Data window, then tap [RADAR].
3. Tap the VRM indication in the [EBL/VRM] data box.
4. Use the VRM, drag the slider bar thumb, tap the slider bar, or tap the range buttons (+, -) as shown below to measure range.
5. Tap [End VRM] at the top of screen to finish.
6. To clear the VRM:
 - Open the Pop-up menu, tap [VRM]→[Clear].
 - Tap the VRM, then tap→[Clear].

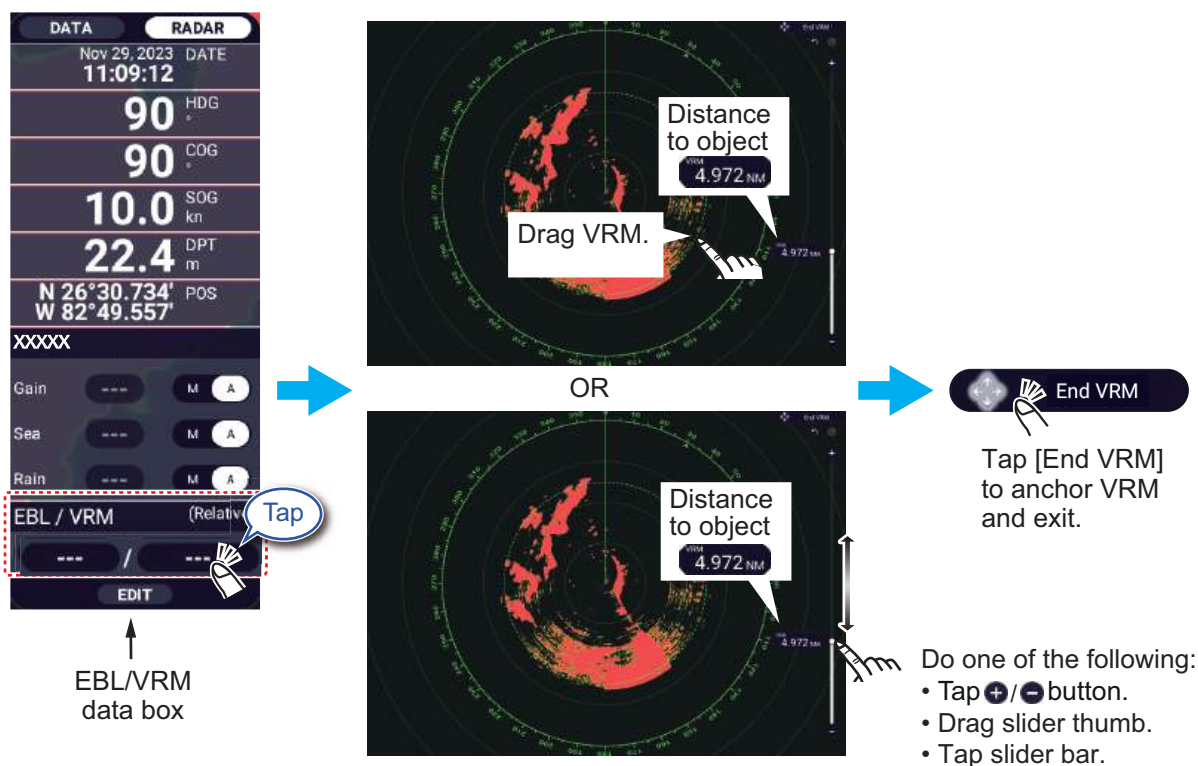

7. RADAR

Method 2: Using the Pop-up menu

1. Tap the radar display to show the Pop-up menu, then tap [VRM]→[Adjust].
2. Use the VRM, drag the slider bar thumb, tap the slider bar, or tap the range buttons (+, -) as shown below to measure range.
3. Tap [End VRM] at the top of screen to finish.
4. To clear the VRM:
 - Open the Pop-up menu, tap [VRM]→[Clear].
 - Tap the VRM, then tap→[Clear]

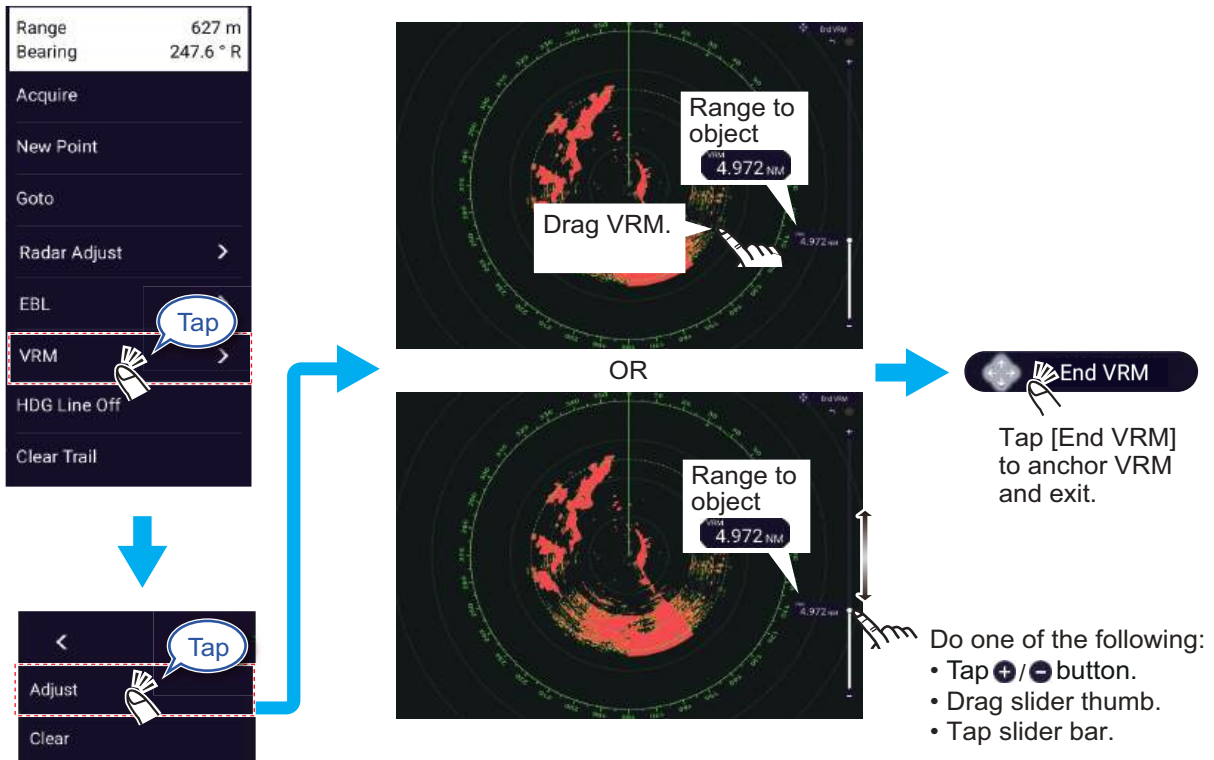

7.9.6 How to measure the bearing with the EBL

Method 1: Using the EBL/VRM box in the Data window

1. Referring to section 1.9.3, add the [EBL/VRM] data box to the [RADAR] Data window.
2. Display the Data window, then tap [RADAR].
3. Tap the EBL indication in the [EBL/VRM] data box.
4. Use the EBL, drag the slider bar thumb, tap the slider bar, or tap the range buttons (+, -) as shown below to measure bearing.
5. Tap [End EBL] at the top of screen to finish.
6. To clear the EBL:
 - Open the Pop-up menu, tap [EBL]→[Clear].
 - Tap the EBL, then tap→[Clear]

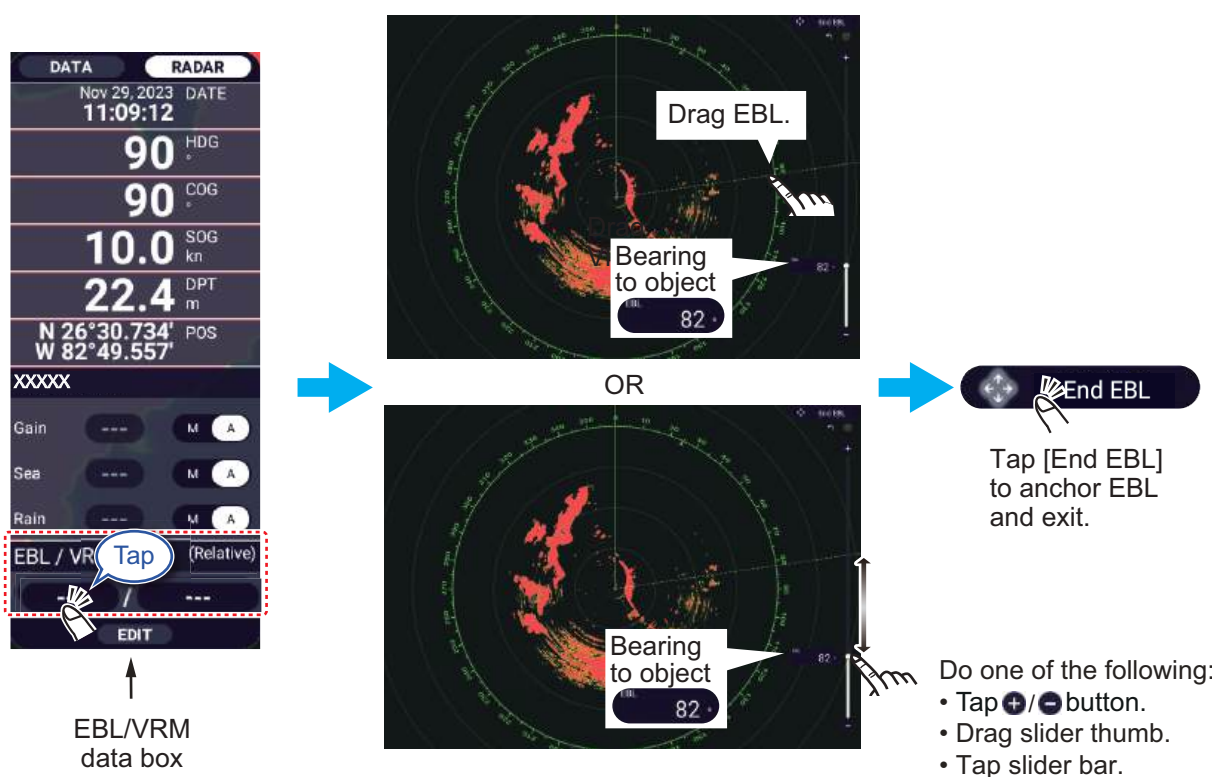

Method 2: Using the Pop-up menu

1. Tap the radar display to show the Pop-up menu, then tap [EBL]→[Adjust].
2. Use the EBL, drag the slider bar thumb, tap the slider bar, or tap the range buttons (+, -) as shown below to measure bearing.
3. Tap [End EBL] at the top of screen to finish.
4. To clear the EBL:
 - Open the Pop-up menu, tap [EBL]→[Clear].
 - Tap the EBL, then tap→[Clear]

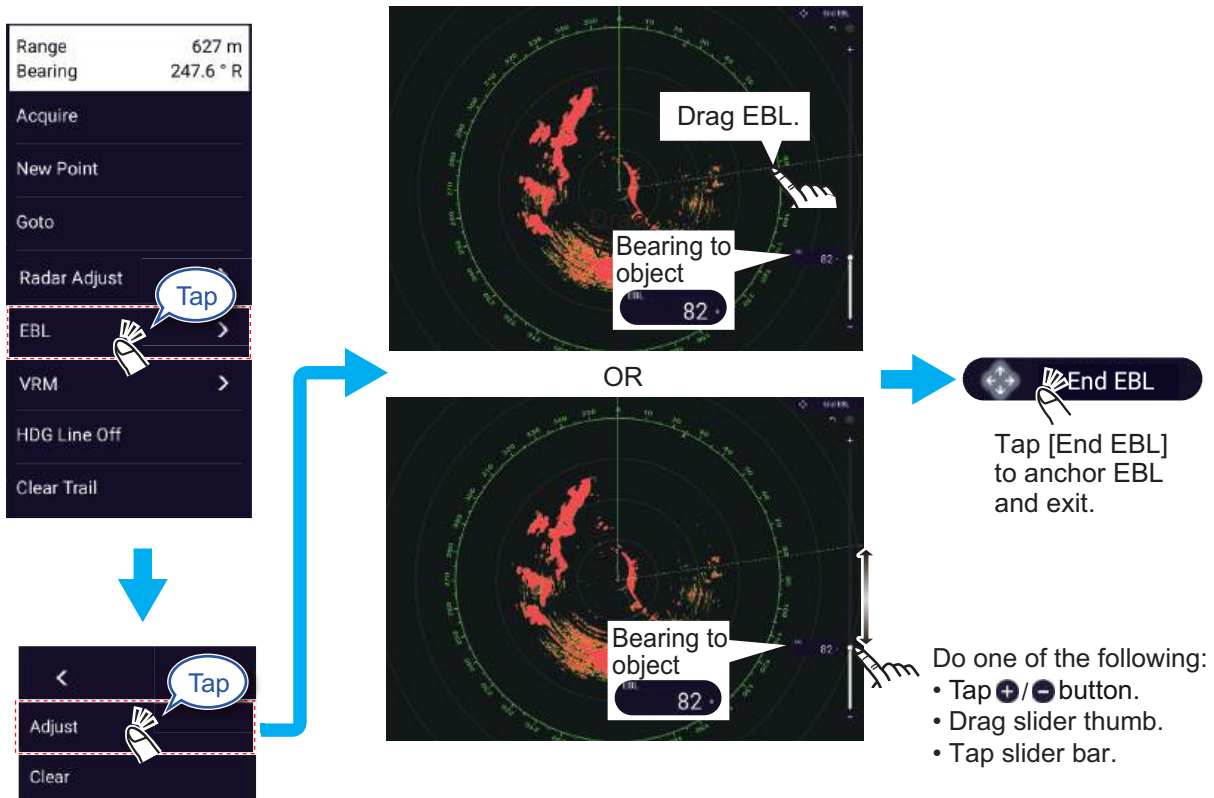
**7.9.7 How to select the EBL reference**

You can select the EBL reference from [True] or [Relative]. [True] means the bearing is in reference to the north. [Relative] means the bearing is relative to the heading of your ship. True bearing requires a heading sensor.

1. Home page→[Settings]→[Radar]→[Radar Initial Setup].
2. Tap [EBL Reference].
3. Tap [True] or [Relative].
4. Tap [x] on the title bar to finish and close the menu.

7.10 How to Measure the Range and Bearing Between Two Targets

You can measure the range and bearing between any two targets with the “ruler” feature, which you can access from the Slide-out menu.

1. Open the Slide-out menu, then tap [Distance] to display the ruler, which has two draggable icons connected with a line.

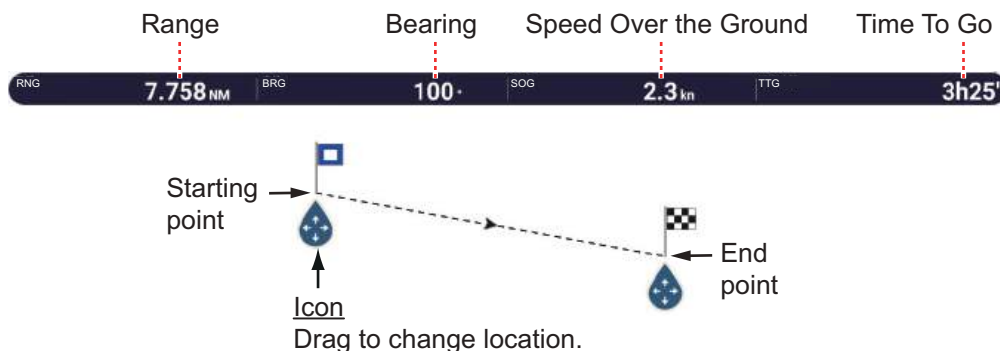

2. Drag the icons to set them on the objects for the measurement. The range and bearing between the objects, SOG and TTG appear at the top of the screen.
3. Tap [Cancel Ruler] at the top right-hand corner of the screen to erase the ruler and the indications.

7.11 How to Off-center the Picture

You can off-center your position to expand the view field without selecting a larger range scale. The position can be off-centered in the bow, stern, port or starboard direction, but not more than 75% of the range in use.

Pan the radar display by dragging with a finger. To return your ship to the center of the screen, tap [Center Radar] at the top right-hand corner of the screen.

 **Center Radar** Appears when ship is not at the center of the screen.



Normal picture



Picture offset in stern direction

7.12 Heading Line

The heading line indicates your heading in all orientation modes. This line connects between your position to the outer edge of the radar display. The line is at zero degrees on the bearing scale in the head-up mode. The orientation of the line changes in the north-up mode with the movement of your ship. If it is hard to identify the echoes on the heading line, you can hide the heading line and range rings for a few seconds. Open the Pop-up menu, then tap [HDG Line Off] to hide the heading line and range rings. The heading line and the range rings reappear after approx. 5-6 seconds.

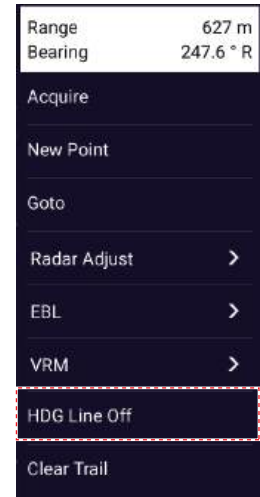

7.13 How to Reduce Radar Interference

Radar interference can occur when your ship is near the radar of another ship that operates on the same frequency band with your radar. The interference shows on the screen in many bright dots. The dots can be random or in the shape of dotted lines that run from the center to the edge of the screen. You can identify the interference from the normal echoes, because the interference does not appear in the same location at the next rotation of the antenna.

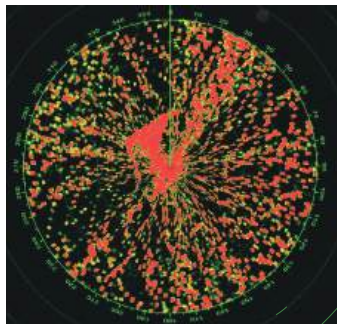

Interference visible
on-screen

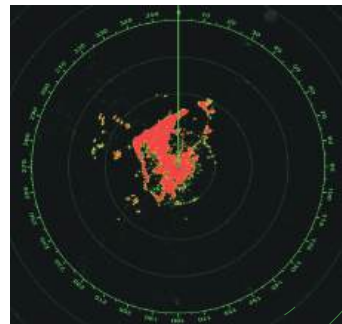

Interference rejector on;
interference suppressed

Turn off the interference rejector when there is no interference to prevent the loss of weak targets.

To use the interference rejector, open the Layers menu, tap the [Overlays] tab, then turn [Interference Rejection] on or off.

7.14 Echo Average

The sea clutter reduction circuit can remove wanted echoes. If this occurs, use the echo average feature. Echo average reduces the brilliance of targets within sea clutter to allow you to better discriminate targets from sea clutter.

Note 1: Echo average requires heading and position data.

Note 2: Do not use echo average during heavy pitching and rolling, to prevent loss of targets.

Note 3: Before using echo average, properly adjust the sea clutter.

Note 4: When two radar screens are displayed on a split screen, echo averaging can be used on screen (1) only. See the figure on page 7-24.

To use the echo average feature, open the Layers menu, tap the [Overlays] tab, then turn [Echo Averaging] off or on as required.

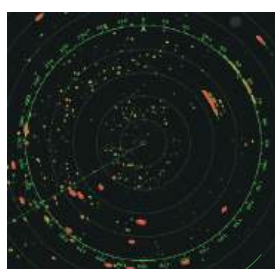

Echo Average OFF

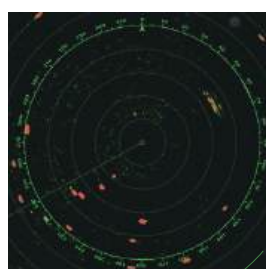

Echo Average ON

7.15 Guard Zone

The guard zone provides aural and visual alarms against targets (ships, islands, land-masses, etc.) that enter the area you set.

7

7.15.1 How to set a guard zone

Note: The available range depends on the radar sensor.

DRS2D-NXT/DRS4D-NXT/DRS6A-NXT/DRS12A-NXT/DRS25A-NXT: 0-24 NM

DRS6A-X Class/DRS12A X-Class/DRS25A X-Class/DRS4DL X-Class/DRS4D X-Class/DRS4DL+: 0-16 NM

1. Open the Layers menu, then tap the [Overlays] tab.
2. Turn on [Guard Zone 1] or [Guard Zone 2].
A dotted white line guard zone appears.
3. Tap on a line of the guard zone to show the Pop-up menu.
4. Tap [Resize]. Draggable icons appear at the corners of the guard zone.
5. Drag the icons to adjust the guard zone.
Note: To create a 360 degree zone about own ship, set all four icons in the same direction.
6. Tap [Done] to finish. The icons disappear.

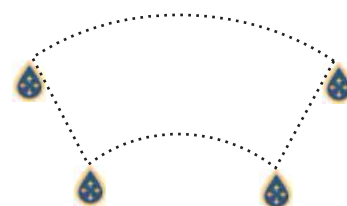
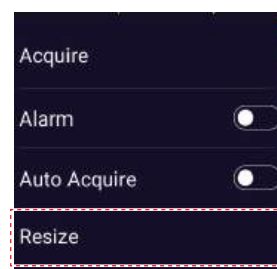

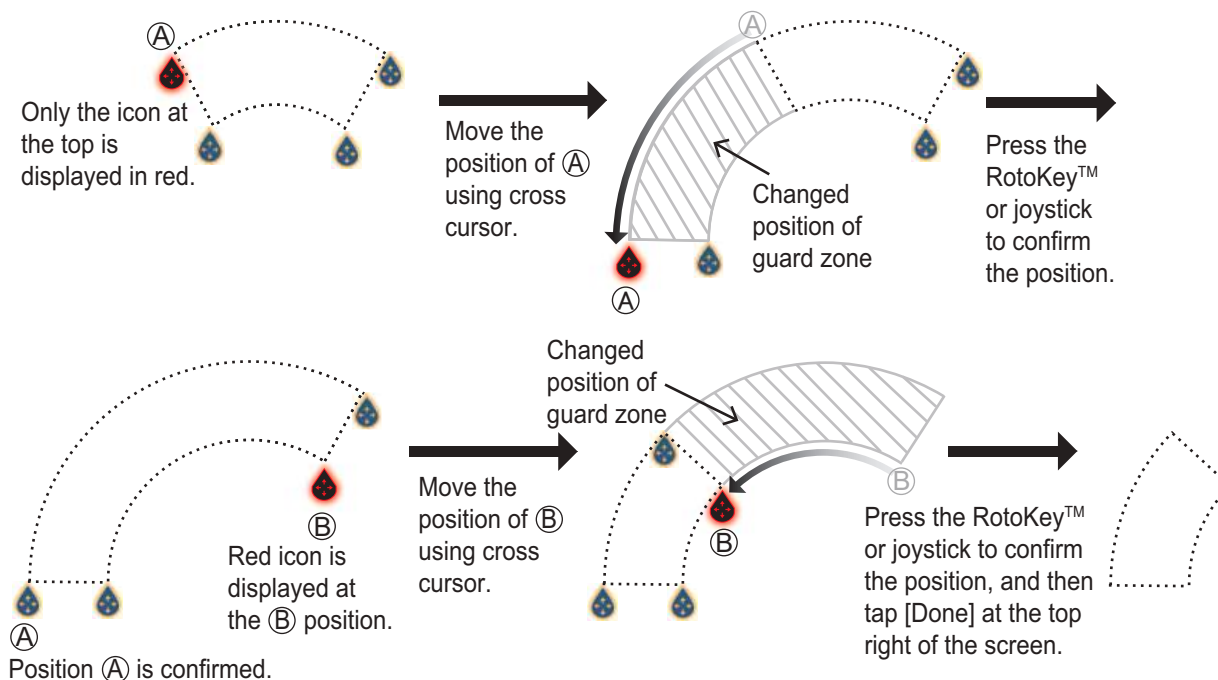
How to set a guard zone with remote controller (MCU-005/006/006H)**7.15.2 How to activate or deactivate a guard zone**

1. Tap on a line of the guard zone to show the Pop-up menu.
2. Turn [Alarm] on or off. The alarm is active when the guard zone lines are solid, and the lines are dashed when the alarm is deactivated.

When a target (including target with echo trail) enters an active zone, the aural alarm sounds (if active), the target flashes, and the message "TARGET ALARM" flashes in the Status bar. Tap the Status bar to silence the aural alarm and stop the flashing message. The message remains in the Status bar and the target continues to flash until the target leaves the guard zone or the alarm is deactivated.

You can mute the audio alarm by turning off [Alarm Sound] in the [Settings]→[Alarms] menu. (see subsection 2.12.8).

7.15.3 How to hide a guard zone

Open the Layers menu, tap the [Overlays] tab, then turn [Guard Zone 1] or [Guard Zone 2] off. The guard zone is erased from the screen.

Note: You can hide the guard zone only when the guard zone function is disabled.

7.16 Watchman

The watchman feature transmits the radar for one minute at a specified time interval (5, 10 or 20 minutes) to monitor the guard zone. If a target is found in the guard zone, the watchman is canceled and the radar continues to transmit. This feature helps you watch for targets in the area you set when you do not continuously require the radar.

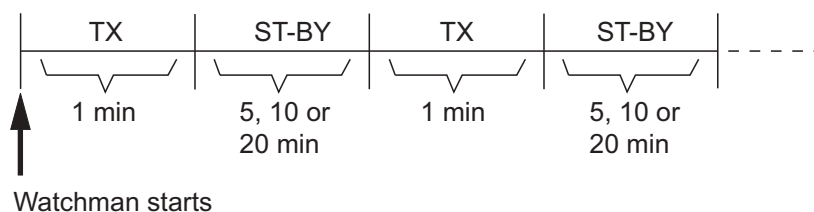

1. Set a guard zone. See section 7.15. (Watchman does not operate unless a guard zone is active. Set Watchman when the radar is in transmit state.)
2. Home page→[Settings]→[Radar]→[Watchman].

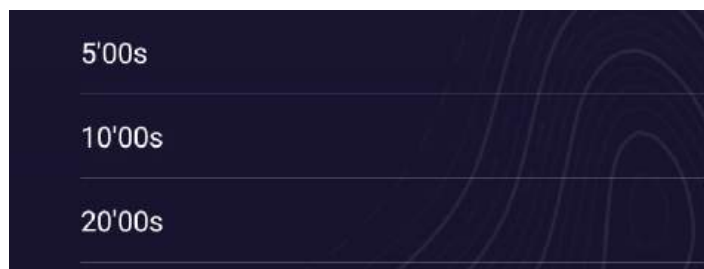

3. Tap a watchman rest interval.
4. Tap [×] on the title bar to finish and close the menu.
5. Open the Layers menu, then tap the [Overlays] tab. Turn [Watchman Mode] on to activate the watchman function.

7.17 Echo Trail

Echo trails show the movements of radar targets relative or true to your ship in imitation afterglow, in a color different from the echo color. This function helps alert you to possible collision conditions.

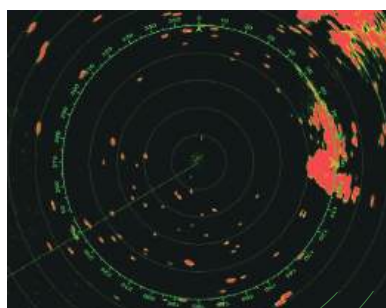

Echo Trails OFF

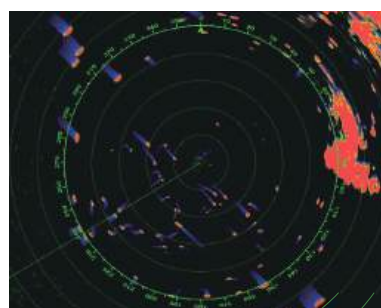

Echo Trails ON

Note: When two radar screens are displayed in a split screen, only one screen can use the echo trail function (see section 7.22).

7.17.1 How to show or hide echo trails

Open the Layers menu, tap the [User Objects] tab, then turn [Show Echo Trails] on or off as required.

7.17.2 How to clear echo trails

Open the Layers menu, tap the [User Objects] tab, then tap [Clear Trail].

7.17.3 How to select echo trail length

1. Home page→[Settings]→[Radar]→[Trail].
2. Tap [Trail Length].

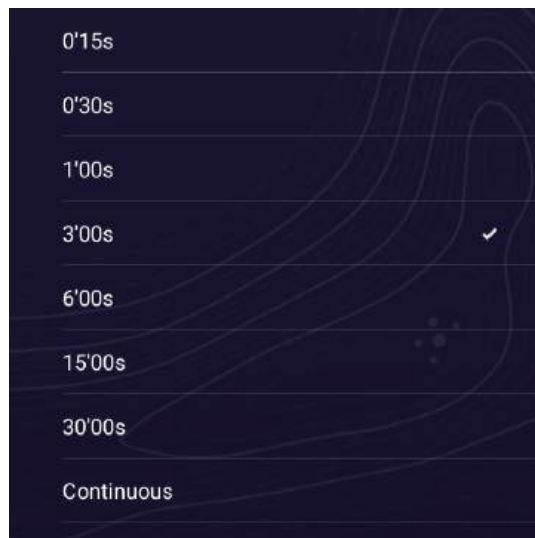

3. Tap desired length.
4. Tap [×] on the title bar to finish and close the menu.

The echo trail length can also be selected from the Layers menu, with [Trails Length] in the [User Objects] tab.

7.17.4 How to select the echo trail mode (reference)

Trail movement can be set for relative or true.

Note: True motion trail requires position and heading information.

Relative trails: Show the relative movements between targets and your ship.

True motion trails: Show the movements of targets according to the targets over-the-ground speeds and courses.

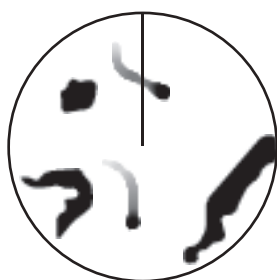

True echo trails
(No smearing of
stationary targets)

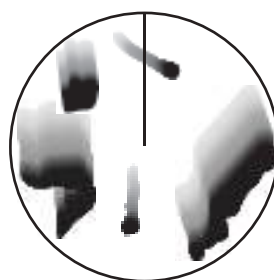

Relative echo trails
(Targets moving relative
to own ship)

1. Home page→[Settings]→[Radar]→[Trail].
2. Tap [Trail Mode]

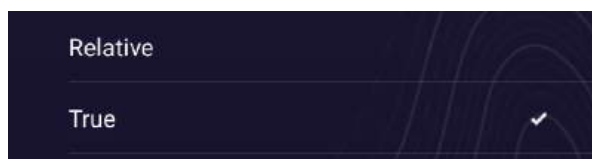

3. Tap [True] or [Relative] as required.
4. Tap [x] on the title bar to finish and close the menu.

Trail mode can also be set from the [User Objects] tab in the Layers menu.

7.17.5 How to select echo trail color

1. Home page→[Settings]→[Radar]→[Trail].
2. Tap [Trail Color].

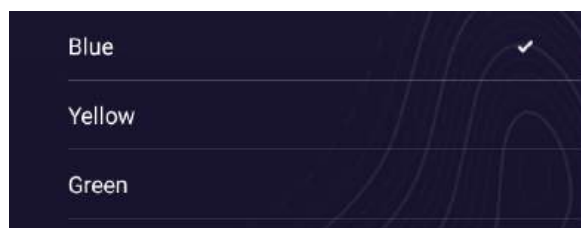

3. Tap desired color.
4. Tap [x] on the title bar to finish and close the menu

Echo trail color can also be set from the [User Objects] tab in the Layers menu.

7.17.6 How to select echo trail shading

The afterglow of the target trails can be shown in a single tone or gradual shading.

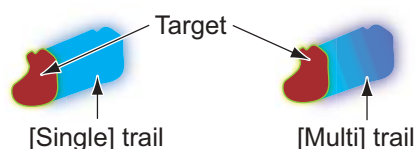

1. Home page→[Settings]→[Radar]→[Trail].

7. RADAR

2. Tap [Trail Shade].

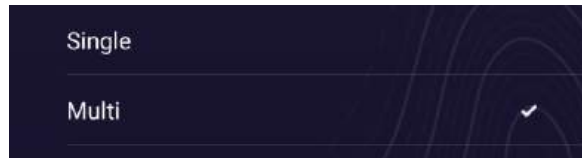

3. Select [Single] or [Multi] as appropriate.
4. Tap [×] on the title bar to finish and close the menu.

Echo trail shading can also be set from the [User Objects] tab in the Layers menu.

7.17.7 How to reset Trail menu items to default

1. Home page→[Settings]→[Radar]→[Trail].
2. [Trail]→[Reset Default Page Settings]→[OK].
3. Tap [×] on the title bar to finish and close the menu.

7.18 How to Show or Hide or Cancel an Active Route

You can show or hide the active route on the radar display. Open the Layers menu, tap the [User Objects] tab, then turn [Show Routes] on or off.

To cancel route navigation, tap any part of the route, then tap [Stop Nav] on the Pop-up menu.

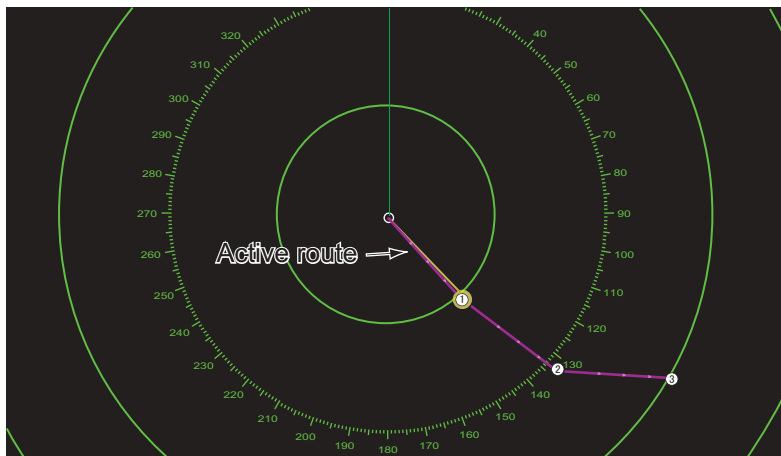

7.19 How to Show or Hide the Own Ship Icon

You can show or hide the own ship icon on the radar display.

1. Home page→[Settings]→[Radar]→[Radar Initial Setup].
2. Turn [Own Ship Icon] on or off.
3. Tap [x] on the title bar to finish and close the menu.

7.20 Echo Color

Echo color is available in colors of green, yellow or multicolor, which displays echoes in colors of red, yellow, and green, corresponding to signal levels of strong, medium and weak.

To select echo color, do the following.

1. Home page→[Settings]→[Radar]→[User Settings].
2. Tap [Echo Color].
3. Select desired color among [Multicolor], [Yellow], [Green].

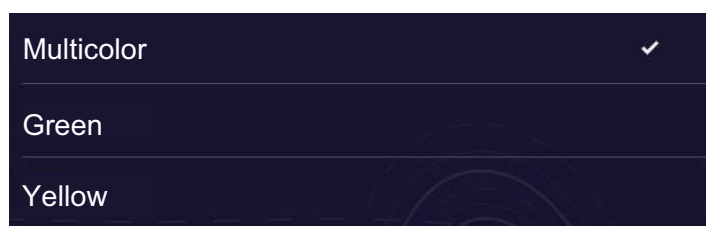

4. Tap [x] on the title bar to finish and close the menu.

7. RADAR

The echo color can also be selected from the [Layers] menu, with [Echo Color] in the [Overlays] tab.

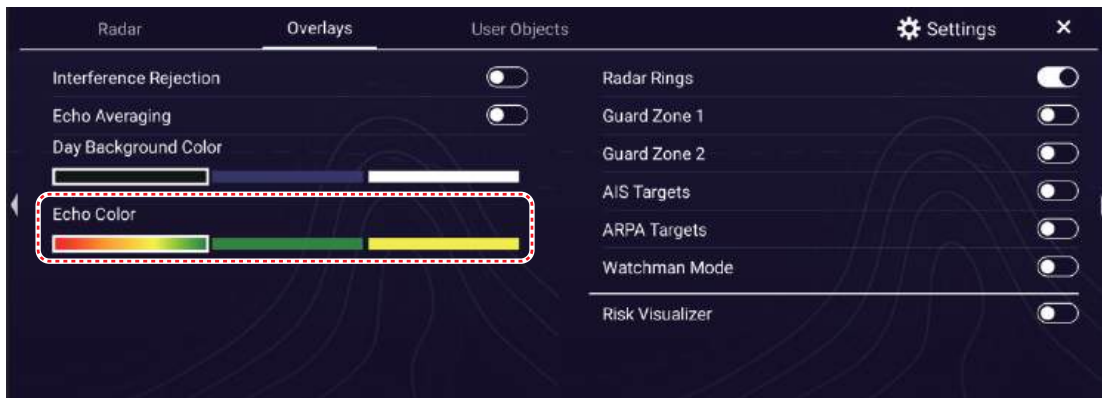

7.21 Background Color

You can select the background color for daytime and nighttime operations.

1. Home page→[Settings]→[Radar]→[User Settings].
2. Tap [Day Background Color] or [Night Background Color] menu.

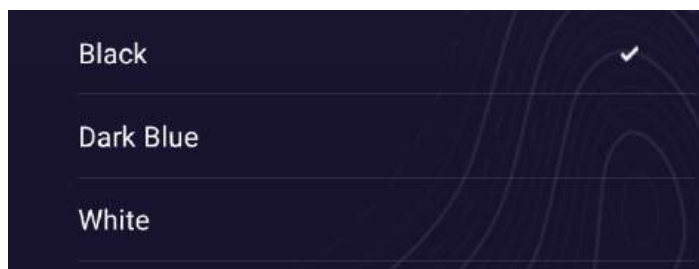

Day Background Color

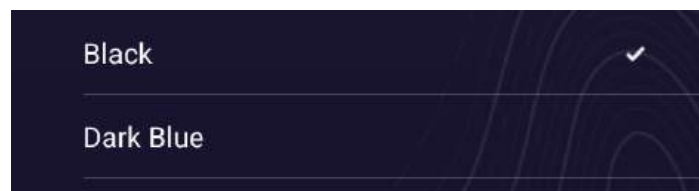

Night Background Color

3. Tap desired color.
4. Tap [x] on the title bar to finish and close the menu.

The day background color can also be selected from the Layers menu, with [Day Background Color] in the [Overlays] tab.

7.22 Dual-Range Display

The dual-range display scans and displays two different radar ranges at the same time, with a single antenna. There is no time delay between the two pictures and, with the magnetron radar, you have separate control of each picture. (The solid state radar has some restrictions. See below for details.) This feature lets you keep a close watch on close-range targets and far targets.

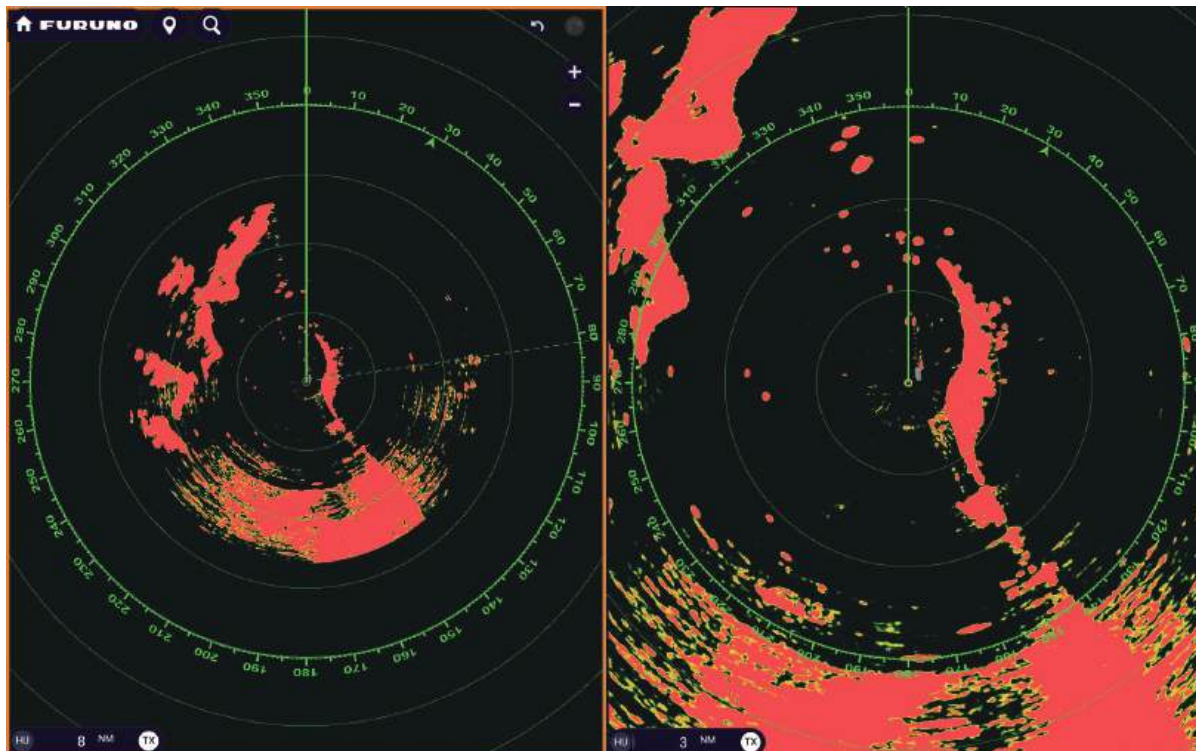

Note: Radar sensor DRS4DL+ does not support the dual-range display.

To get the dual-range display, set dual-range displays on the Home page. See subsection 1.7.1 for the procedure. You can put the dual-range displays in the two-, three-, four-way split screens.

Most radar functions can be adjusted independently. The table below shows radar function and operability in the dual range mode, for both the magnetron radar and the solid state radar. Note that, in the worst case, the maximum detection range may decrease by approx. 10 dB with the solid state radar.

- | | |
|---|------------------------------|
| • Active route (show or hide) | • Radar TX ^{*2} |
| • Rain clutter suppression | • Gain adjustment |
| • Heading line, range rings (temporarily erase) | • Sea clutter removal |
| • Range change | • AIS/ARPA (show or hide) |
| • Operation mode (head-up or north-up) | • Range rings (show or hide) |
| • Auto sea mode ^{*1} | • Bird mode |

^{*1}: This function is not available with the DRS2D-NXT/DRS4D-NXT/DRS6A-NXT/DRS12A-NXT/DRS25A-NXT.

^{*2}: Referring to the figure on the next page, independent TX is available with screen (1), but not available with screen (2). In other words, when screen (2) is in standby,

7. RADAR

independent TX is possible from screen (1), however, when screen (1) is in standby and screen (2) transmits, screen (1) stays in standby.

Two-way split screen

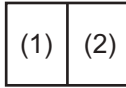

Three-way split screen

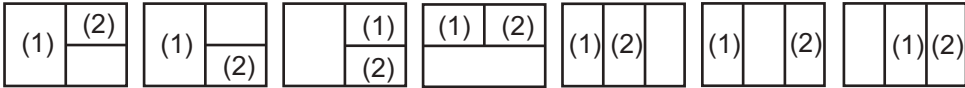

Four-way split screen

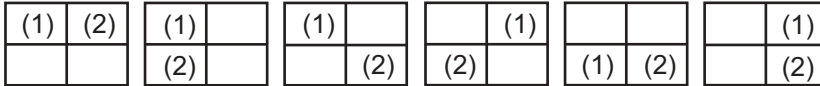

7.23 Bird Mode

The Bird mode sets up the radar for optimal detection of flocks of birds, which indicates the presence of schools of fish. Additionally, the bird mode can be used to detect distant rain clouds.

Gain, sea clutter and rain clutter are automatically adjusted according to the bird mode setting.

The use of echo trail and echo average functions together with the Bird mode make it easier to distinguish bird echoes from other echoes. With echo average, echoes from birds are emphasized. With true echo trails, moving vessels show long, steady trails. Unlike those targets, bird echoes appear randomly and show random, short trails.

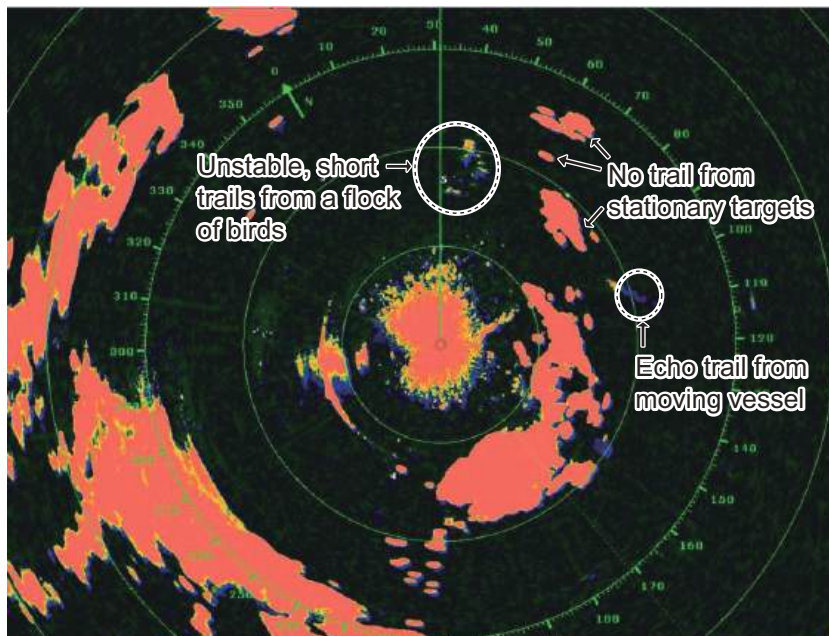

The Bird mode has three settings. Select the option according to the severity of the sea clutter.

To select the Bird mode setting, open the Layers menu, tap the [Radar] tab, then tap [Calm], [Moderate], or [Rough] at [Bird Mode Sea Condition].

[Calm]: Suitable in calm conditions where sea clutter is weak. Applies low sea clutter reduction to show weak bird echoes. When sea clutter is strong, bird echoes may be hidden inside the sea clutter.

[Moderate]: Suitable where sea clutter is moderate. Applies medium sea clutter reduction.

[Rough]: Suitable in rough weather conditions where sea clutter is strong. Applies high sea clutter reduction. Weak bird echoes may be suppressed in this setting.

To turn off the Bird mode, select [Off]. When the Bird mode is active, the bird mode icon appears to the right of the TX/STBY switch, as shown below.



Note: When the Risk Visualizer™ function is active, the Risk Visualizer™ icon is shown as the highest priority.

Usage cautions, restrictions

- Do not use the Bird mode during a voyage. The Bird mode sea condition settings are not suitable in a voyage.
- ARPA performance may be reduced when the Bird mode sea condition is active.
- Do not use the Bird mode in rough weather.
- Radar Adjust (Gain, Sea, Rain) and Auto Sea Mode cannot be adjusted when the Bird mode is active.
- The radar sensor DRS4DL+ does not support the bird mode feature.
- Birds targetting schools of fish may suddenly dive into the sea, which can cause the echoes from the birds to become unstable or disappear.
- The Bird mode feature, target analyzer (section 7.24), and full auto tracking (section 7.26.5) cannot be used simultaneously, The function last turned on is enabled.

7.24 Target Analyzer™

The Target Analyzer™ analyzes echoes and displays targets in different colors to help you distinguish targets that are moving and approaching own ship. Use this function to distinguish targets from heavy rain or snow.

Note 1: Requires GPS position data and one of the following radar sensors. DRS2D-NXT/DRS4D-NXT/DRS6A-NXT/DRS12A-NXT/DRS25A-NXT

Note 2: [Radar Adjust] (Gain, Sea, Rain) and [Auto Sea Mode] cannot be adjusted when this function is active.

Note 3: This function cannot be used together with the Bird mode. The function last turned on is activated.

Note 4: The Target Analyzer™ works only against moving targets. Stationary targets, such as a buoy, are not identified as an approaching target.

Note 5: When the radial component* of target velocity (see below for description) is 50 kn or higher, the target may be painted in a wrong color. For example, an approach-

7. RADAR

ing target whose speed is 50 kn or higher should be painted in red, but is painted in green.

* **Radial component of target velocity:** The target velocity can be separated into two components, the radial and transverse components, as in the figure below. The radar is only able to sense the motion directly along the radial, either towards or away from the radar, because the transverse component has no effect on the phase of the returning electromagnetic wave.

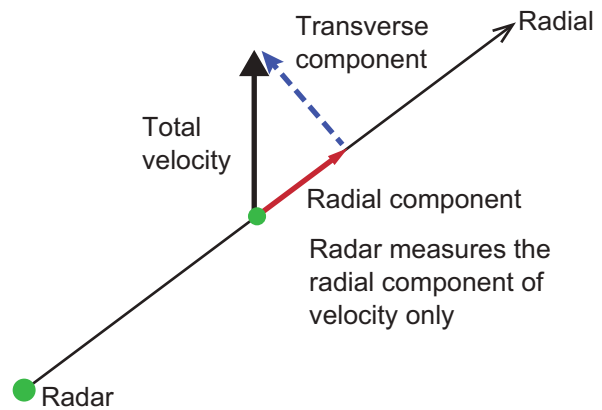

The Target Analyzer™ is activated, deactivated from the Layers menu. Open the Layers menu, tap the [Radar] tab, then set [Target Analyzer] to [Target], [Rain] or [Off]. Targets are shown in colors according to the setting on the Layers menu, as shown in the table below.

Setting	Target	Rain	Echo color
[Off]	Off	Off	Echoes are painted according to the echo color selected in section 7.20.
[Target]	On	Off	Moving targets: Red Other targets: Green
[Rain]	On	On	Rain: Blue Moving targets: Red Other targets: Green

When the Target Analyzer™ is active, the target analyzer icon appears to the right of the TX icon at the bottom left corner.

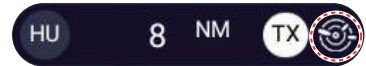

Note: When the Risk Visualizer™ function is active, the Risk Visualizer™ icon is shown as the highest priority.

The figure below shows an actual radar image with the Target Analyzer™ activated.

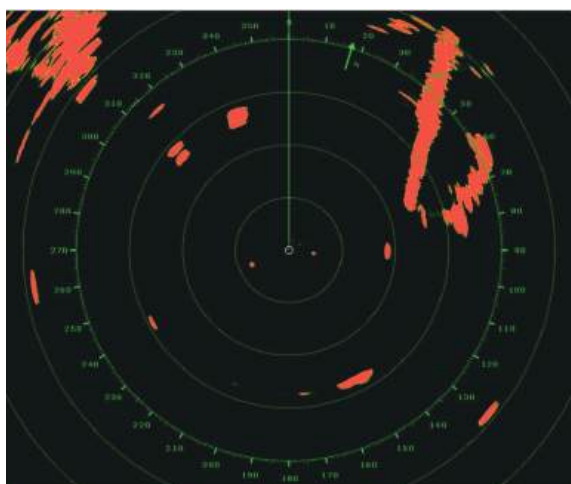

Target Analyzer™: OFF

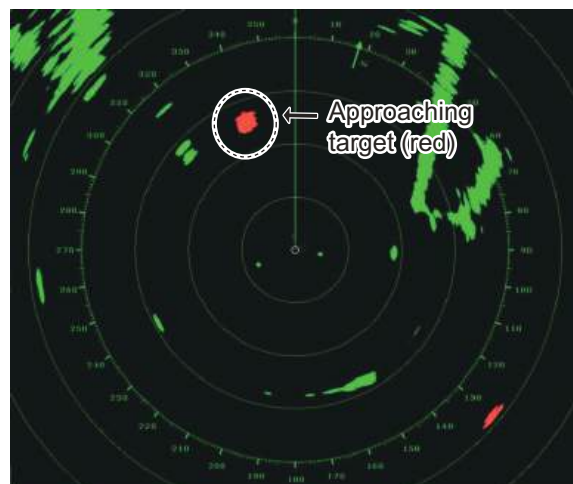

Target Analyzer™: Target Mode

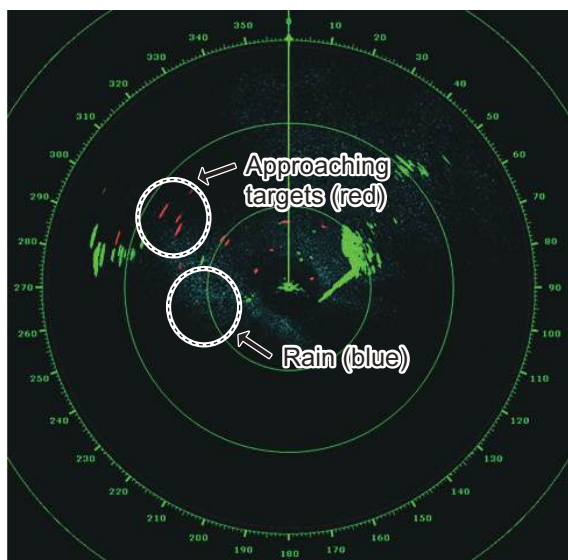

Target Analyzer™: Rain Mode

Operating mode and range

	Range (Target Analyzer™ Off)	Range (Target Analyzer™ On)
Single range display	0.063 - 72 NM	0.063 - 24 NM
Dual range display	0.063 - 12 NM	0.063 - 12 NM

7.25 RezBoost™

RezBoost™ increases echo resolution. Four settings are available, [Standard], [Enhanced1], [Enhanced2], or [Enhanced 3]. Select [Enhanced 3] for better echo resolution.

Note: RezBoost™ requires one of the following radar sensors.
DRS2D-NXT/DRS4D-NXT/DRS6A-NXT/DRS12A-NXT/DRS25A-NXT

1. Open the Layers menu, then tap the [Radar] tab.
2. Select [RezBoost].
3. Select desired setting, referring to the figure below for information.

7. RADAR

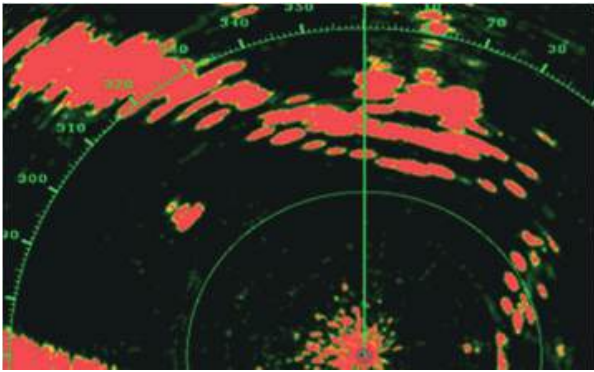

Standard setting
Conventional radar echoes

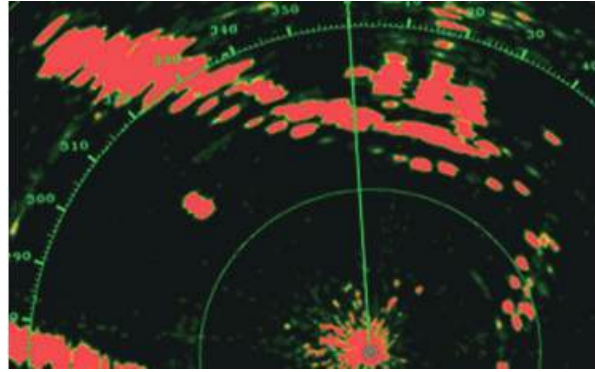

Enhanced 1 setting
Sharper than standard by 1.2 times
Equivalent to 3.4° beam width

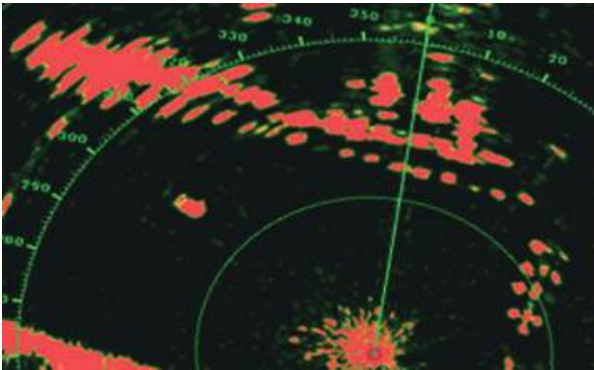

Enhanced 2 setting
Sharper than standard by 1.5 times
Equivalent to 2.7° beam width

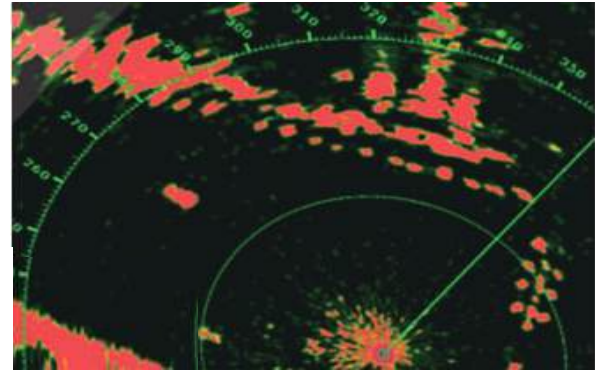

Enhanced 3 setting
Sharper than standard by 2 times
Equivalent to 2.0° beam width

7.26 ARPA Operation

The ARPA (Automatic Radar Plotting Aid) tracks manually and automatically acquired radar targets. ARPA requires speed and heading data. The number of targets acquirable is as shown below.

- **Automatic acquisition area inactive:** Targets can be acquired manually (max. 30 targets).
- **Automatic acquisition area active:**

Radar model	Manual track	Automatic track (guard zone)	Automatic track (doppler)
DRS4DL+	Max. 15 targets	Max. 15 targets	-
DRS2D-NXT/ DRS4D-NXT/ DRS6A-NXT/ DRS12A-NXT/ DRS25A-NXT	Max. 30 targets	Max. 30 targets	Max. 40 targets
DRS6A X-Class/ DRS4D X-Class	Max. 30 targets	Max. 70 targets	-
DRS4DL X-Class	Max. 25 targets	Max. 25 targets	-

 **WARNING**

No one navigational aid should be relied upon for the safety of vessel and crew. The navigator has the responsibility to check all aids available to confirm position. Electronic aids are not a substitute for basic navigational principles and common sense.

- This auto plotter automatically tracks an automatically or manually acquired radar target and calculates its course and speed, indicating them by a vector. Since the data generated by the auto plotter are based on what radar targets are selected, the radar must always be optimally tuned for use with the auto plotter, to ensure required targets will not be lost or unwanted targets such as sea returns and noise will not be acquired and tracked.
- A target does not always mean a landmass, reef, ships or other surface vessels but can imply returns from sea surface and clutter. As the level of clutter changes with environment, the operator should properly adjust the Sea, Rain and Gain to be sure target echoes are not eliminated from the radar screen.

 **CAUTION**

The plotting accuracy and response of this auto plotter meets IMO standards. Tracking accuracy is affected by the following:

- Tracking accuracy is affected by course change. One to two minutes is required to restore vectors to full accuracy after an abrupt course change. (The actual amount depends on gyrocompass specifications.)
- The amount of tracking delay is inversely proportional to the relative speed of the target. Delay ranges from 15 - 30 seconds for high relative speed; 30 - 60 seconds for low relative speed.

Display accuracy is affected by the following:

- Echo intensity
- Radar transmission pulsewidth
- Radar bearing error
- Gyrocompass error
- Course change (your ship or target)

7.26.1 How to show or hide the ARPA display





From the radar display or chart plotter display, open the Layers menu, tap the [Overlays] tab, then turn [ARPA Targets] on or off (hides ARPA symbols).

Note: The size of ARPA symbols (including text font size) can be changed as follows: [General]→[This Display]→[Plotter Objects Size].

7.26.2 How to manually acquire a target

You can manually acquire a target from both the radar display and the radar display overlay. Up to 30 targets can be acquired manually. Tap the target to acquire to show the Pop-up menu, then tap [Acquire].

After you acquire a target, the radar marks the target with a broken square and a vector appears within 30 s (default setting). The vector indicates the direction of the target. Within 90 s after you acquire the target, the first tracking step is finished and the target is tracked continuously. At this point, the broken square changes to a solid circle.

ARPA Symbol	Meaning	ARPA Symbol	Meaning
 Color: green	At acquisition of the target.	 Color: green	30 s after the acquisition, the plotting symbol changes to a small circle, which indicates steady-state tracking. A vector (dashed line) shows the direction of the target.
 Color: green	A lost target is indicated by a diamond symbol, created from two equal triangles.	 Color: red	A target that meets the criteria of the CPA/ TCPA alarm is changed to a dangerous target.

Note 1: For successful acquisition, the target must be within 0.05 to 16 NM from your ship and not hidden in sea or rain clutter.

Note 2: When the capacity for manual acquisition is reached, you cannot acquire more targets. Cancel tracking of non-threatening targets to acquire additional targets manually.

7.26.3 How to automatically acquire a target

Any target that enters the ARPA acquisition area is acquired and tracked automatically. When a target enters the area, the buzzer sounds. To disable the buzzer, turn [Alarm] off in the Pop-up menu at step 2 in the below procedure.

1. Create a guard zone referring to section 7.15.

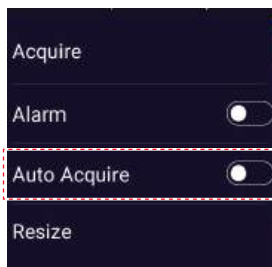

2. Tap a line on the guard zone to show the Pop-up menu. Turn on [Auto Acquire]. The dotted lines for the guard zone turn into solid lines.

7.26.4 How to automatically acquire targets by Doppler

With acquisition by Doppler activated, the number of targets acquirable is as follows.

- 40 targets by auto acquire by Doppler
- 30 targets by auto acquire by guard zones
- 30 targets by manual acquisition

Note: This feature requires the radar sensor DRS2D-NXT/DRS4D-NXT/DRS6A-NXT/DRS12A-NXT/DRS25A-NXT and position and heading inputs.

When automatic acquisition by Doppler is activated, approaching targets (ships, rain clutter, etc.) within 3 NM from own ship are automatically acquired by the Doppler calculated from the radar echo.

This feature, when active, runs in the background immediately after the start of transmission. Targets are acquired in order of distance from own ship, from nearest to furthest. Once a target is acquired, tracking continues regardless of subsequent Doppler behavior, even if the target becomes stationary. Targets can still be manually acquired provided that the capacity for automatic acquisition has not been reached.

Auto acquisition by Doppler is turned off in the default setting. To activate this feature, open the [Radar] menu, then turn on [Auto acquire by Doppler].

7.26.5 Full auto tracking (TZT9E/13E only)

Targets within 3 NM from your ship will be automatically acquired, and targets that are currently being tracked are automatically released from acquisition and tracking. The number of targets acquirable is as follows.

- 70 targets by full auto tracking
- 30 targets by manual acquisition

Additionally, the gain and sea surface reflection suppressor are automatically set to optimal conditions for ARPA detection.

Usage cautions, restrictions

Note 1: Requires the radar sensor DRS2D-NXT/DRS4D-NXT/DRS6A-NXT/DRS12A-NXT/DRS25A-NXT, and position and heading data.

DRS2D-NXT/DRS4D-NXT: App: V1.11 or later, FPGA: V1.08 or later

DRS6A-NXT/12A-NXT/25A-NXT: App: V1.11 or later, FPGA: V1.04 or later

Note 2: This function cannot be used at the same time as the bird mode (see section 7.23). The function last activated takes precedence.

Note 3: If your ship's structures block the radar beam, set up a blanking sector, to lessen the risk of incorrect tracking due to false images.

Note 4: Automatic acquisition by Doppler and automatic acquisition by guard zone are deactivated when full auto tracking is activated.

Note 5: Targets near land may not be automatically captured. Additionally, targets located in the blanking sector from the ship's position (targets behind structures such as land, embankments, bridges, etc.) cannot be automatically captured.

Note 6: It is recommended to use this function with wind speeds of 10 m/s or less.

How to use the full auto tracking feature

Open the Layers menu, tap the [Radar] tab, then set [Full Auto Tracking Sea Condition] referring to the setting descriptions below. To deactivate this feature, select [Off].

This feature has three settings:

[Calm]: This setting is ideal for calm conditions where sea surface reflections are weak. Sea clutter removal is set to low to show weak echoes from ARPA. If the sea surface reflection is strong, the echo from ARPA may be hidden by the sea surface reflection echo.

[Moderate]: Use this option when sea surface reflections are moderate. Sea reflection removal is set to medium.

[Rough]: This setting is ideal for use when sea surface reflections are strong. Sea clutter removal is set to high. Weak echoes from ARPA may be suppressed together with sea surface reflections.

When the full auto tracking is active, the icon shown in the figure below appears next to the [TX] icon at the bottom left corner of the screen.



Note 1: When the Risk Visualizer™ function is active, the Risk Visualizer™ icon is shown as the highest priority.

Note 2: If [Full Auto Tracking Sea Condition] is inactive when the [Avoidance Route] feature (see section 5.13) is activated, [Full Auto Tracking Sea Condition] is automatically activated and is set to [Moderate].

Note 3: If both [Full Auto Tracking Sea Condition] and [Avoidance Route] (see section 5.13) are active, both are deactivated when [Full Auto Tracking Sea Condition] is turned off.

Note 4: When you change the setting of [Full Auto Tracking Sea Condition] from [Off] to [Calm], [Moderate] or [Rough] or vice versa, all ARPA symbols on the screen are cleared.

7.26.6 How to display target data

You can find the bearing, range, etc. of an ARPA target. Tap the ARPA target to get its basic information, in the Pop-up menu. For detailed information, tap the ARPA target to display the Pop-up menu, then tap [Info].

ID	19
COG	144.6 °
SOG	17.2 kn
Range	814 m
Bearing	2.5 °
CPA	159 m
TCPA	1'19s
Acquire	
Cancel	
Clear	
New Point	
CPA	<input type="checkbox"/>

Basic ARPA target info

Target Info	
Nickname	<input type="text"/>
ID	19
COG	144.4 °
SOG	17.2 kn
CPA	167 m
TCPA	1'14s
Range	761 m
Bearing	3.3 °
Status	Tracking
Lat	N 26°31.115'
Lon	W 83°04.546'

Detailed ARPA target info

You can assign a nickname to ARPA targets. Tap [ID] in the basic information or [Nickname] in the detailed information to open the [Nickname] edit screen.

7.26.7 How to stop tracking targets

You can stop tracking ARPA targets individually or all together.

Individual target

Tap the ARPA target to display the Pop-up menu, then tap [Cancel] to stop tracking and delete the ARPA target from the screen.

All targets

Open the Slide-out menu, tap [ARPA], then tap [Cancel All] to delete all ARPA targets from the screen.

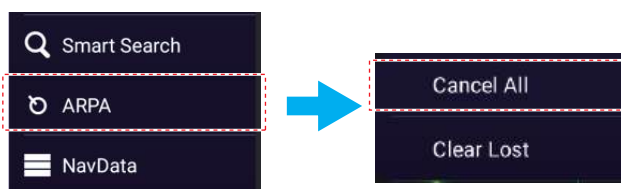

7.26.8 ARPA list

The [ARPA] list displays data for all ARPA targets being tracked.

How to show the ARPA list

To show the list, Home page→[Lists]→[ARPA]. The color marks at the left side of the list denote ARPA symbol status, green for tracking or lost target, red for dangerous target.

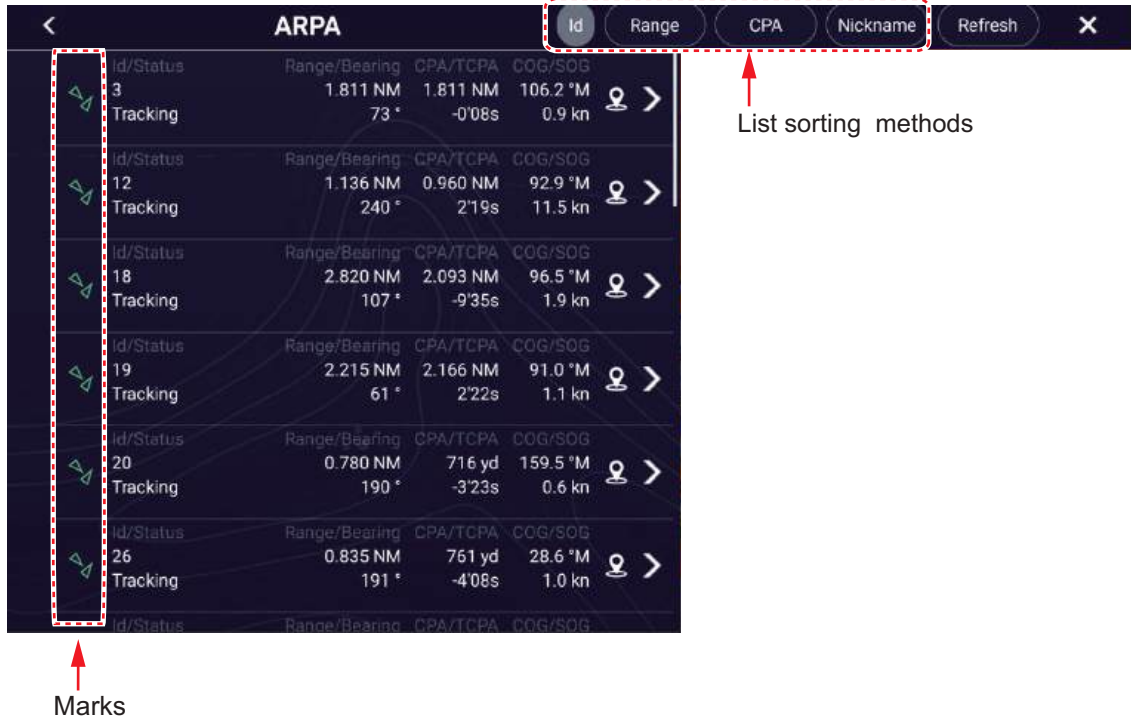

To sort the list, tap appropriate sort method button at the top of the list.

[Id]: Sort by ID no.

[Range]: Sort by range, closest to furthest from own ship.

[CPA]: Sort in CPA order.

[Nickname]: Sort by nickname, followed by ID no. in case of no nickname.

The [Refresh] button updates target data.

How to show detailed ARPA target information

Tap the target on the [ARPA] list to see its information.

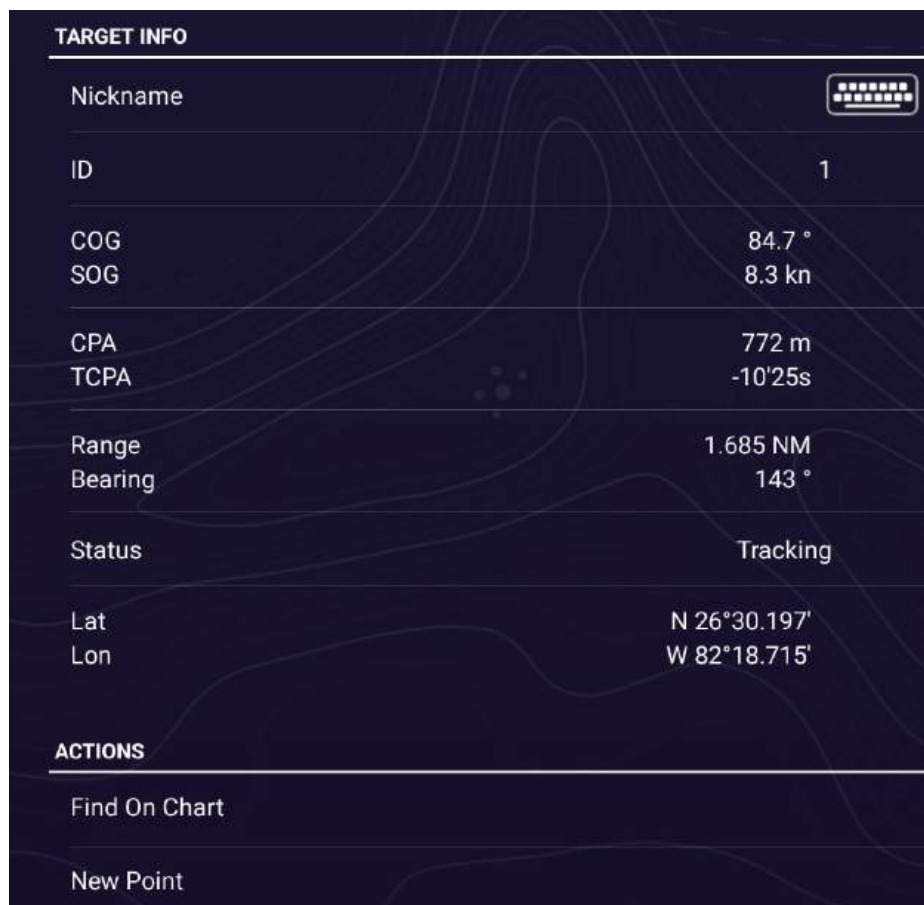

How to edit nickname for an ARPA target

1. On the [ARPA] list, tap the target for which you want edit its nickname.
2. Tap [Nickname] to show the software keyboard.
3. Enter the nickname (max. 20 characters), then tap [✓].
4. Tap [×] on the title bar to finish and close the menu.

Note: The nicknames for lost and manually cleared ARPA targets are cleared.

How to put an ARPA target at the center of the chart plotter display

Tap a target on the [ARPA] list, then tap [Find on Chart]. The ARPA target appears at the center of the chart plotter display.

How to put a point at the position of an ARPA target

On the [ARPA] list, tap the ARPA target for which you want to register a point. Tap [New Point] at the bottom of the detailed information window. A point then appears near the ARPA target on the chart plotter display.

7.26.9 How to clear lost targets

Tracking of a target cannot be continued when the echo from that target becomes lost. However, a lost target can be tracked after it is reacquired. Lost targets can be cleared individually or collectively.

Individual target

Tap the target to display the Pop-up menu, then tap [Clear] to clear the target from the screen.

Clear all targets

Open the Slide-out menu, tap [ARPA], then tap [Clear Lost] to delete all lost targets from the screen.

7.26.10 CPA/TCPA alarm

This alarm helps you keep your ship away from collision by warning of targets on a collision course. The ARPA continuously monitors the predicted range at the Closest Point of Approach (CPA) and predicted time to CPA (TCPA) of each tracked target. When both the predicted CPA and TCPA are less than their set values, the target symbol turns red, the alarm sounds and the flashing message "CPA/TCPA Alarm" appears at the top of the screen.

This alarm is a useful feature to avoid collisions with targets. However, it is important that settings such as gain, sea surface reflection removal, and rain and snow reflection removal are set correctly.

CPA/TCPA alarm ranges must be set correctly according to the size, tonnage, speed, turning performance and other characteristics of your ship.

How to set the CPA/TCPA alarm

1. Home page→[Settings]→[Targets]→[Collision Alarm].
2. Tap [CPA/TCPA Alarm].
3. Tap [<] to go back one layer in the menu.
4. Tap [CPA Alarm Value] or [TCPA Alarm Value] to display the software keyboard.
5. Set the value, then tap [✓] to confirm.
6. Tap [×] on the title bar to finish and close the menu.

How to acknowledge the CPA/TCPA alarm

The CPA/TCPA alarm sounds when the CPA and TCPA of an ARPA target are within the CPA/TCPA alarm range. The alarm indication "CPA/TCPA Alarm" appears and flashes at the top of the screen. To acknowledge the alarm and stop the audio alarm and flashing of the indication, tap the indication "CPA/TCPA Alarm" (see subsection 2.12.9). (The ARPA vector must be displayed at least 30 seconds to calculate CPA and TCPA.)

How to deactivate the CPA/TCPA alarm

1. Home page→[Settings]→[Targets]→[Collision Alarm].
2. Tap [Off].
3. Tap [×] on the title bar to finish and close the menu.

7.26.11 CPA graphic display

The CPA graphic display shows the CPA between own vessel and the selected ARPA (or AIS) target with a line, called the "CPA line." Whenever you change your vessel's course and speed, you can see the new CPA between your vessel and the selected ARPA target.

To activate or deactivate the CPA graphic display, open the [Targets] menu, then turn [CPA Graphic Display] on or off.

To find the CPA of a ARPA target on the radar or chart plotter display, tap the ARPA target. The CPA line connects between your vessel and the CPA of the ARPA target. The color of the line is the same as that of the target symbol. To find the CPA of another ARPA target, select it, and the CPA line moves to the newly selected target. (Only one line can be displayed at a time.) The example at right shows the appearance of the CPA line on the radar display.

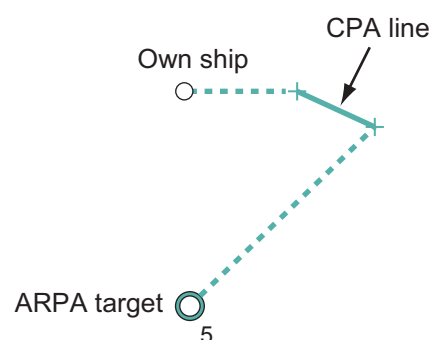

If the CPA/TCPA alarm is generated while the CPA line is in use, the CPA line and the symbol of the selected target turn red.

The CPA graphic display is not available in the following conditions:

- The CPA line is turned off. The line can be turned off by tapping the CPA line (or vessel icon* or target) to show the Pop-up menu, then select [CPA].
* Chart plotter display only
- The feature is turned off.
- The TCPA is a minus (-) value.
- The target is a lost target.
- The CPA and TCPA of the target cannot be calculated (no speed or heading data for own ship).

7.26.12 Risk Visualizer™ (TZT9E/13E only)

Risk Visualizer™ calculates the speed of ARPA targets and your ship to determine the possibility of collision with ARPA targets. If the possibility of collision is found, the collision area is graphically shown on the chart plotter and radar displays. For details, see section 5.12.

When the Risk Visualizer™ function is active, the icon shown on the right-hand figure appears next to the [TX] icon at the bottom left corner of the screen. Whether the icon appears or not is shared by all NavNet TZtouch series connected to the same network. When the Bird mode, Target Analyzer™, or Full Auto Tracking function is enabled, the Risk Visualizer™ icon is shown as the highest priority.



7.27 Connecting With FAR-2xx7/FAR-2xx8/FAR-15x3/FAR-15x8 Series Radars (TZT9E/13E Only)

Your TZT9E/13E can be connected to these FURUNO radars:

- FAR-2xx8 series* (version no. 01.10 or after)
- FAR-2xx7 series (C series, version no. 04.08 or after)
- FAR-15x3/15x8 (version no. 01.19 or after)

*: These radars cannot be connected:

- FAR-2258
- FAR-2228-NXT
- FAR-2328-NXT
- FAR-2268DS
- FAR-2228-NXT-BB (Not available in Japanese market.)

Note: Polygon acquisition zones must also be disabled at the radar.

Radar function	Available with the TZT9E/13E	Remarks
Split-screen display	No	
Display AIS target data	Yes	
ARPA automatic acquisition	No	
ARPA manual acquisition and removal	Yes	Up to 100 targets.
AUTO RAIN	No	
AUTO SEA	Yes	On/Off operation only, setting adjustment must be done at the radar.
Automatic gain adjustment	No	
Echo average	Yes	
Manual rain/snow clutter removal	Yes	
Manual gain adjustment	Yes	
Toggle transmit and standby modes	Yes	
Interference rejector	Yes	
Tuning, antenna speed and other post-installation adjustments	No	
Radar source selection, display of echoes	Yes	
Selection of range unit	No	Fixed at [NM].
Changing the range	Yes	Following ranges only: 0.125, 0.25, 0.5, 0.75, 1, 1.5, 2, 3, 4, 6, 8, 12, 16, 24, 32, 48, 96 (nm).
Watchman feature	No	
ACE GAIN	Yes	*: This function is available for the FAR-2xx8, FAR-15x3/15x8 series and requires ACE GAIN to be enabled from the radar. Note: The echo looks different from what appears on the FAR-15x3/15x8/2xx8. To use the ACE function, enable signal processing from the TZT9E/13E.

7.28 Radar Menu

This section provides the descriptions for the radar menu items not mentioned earlier.

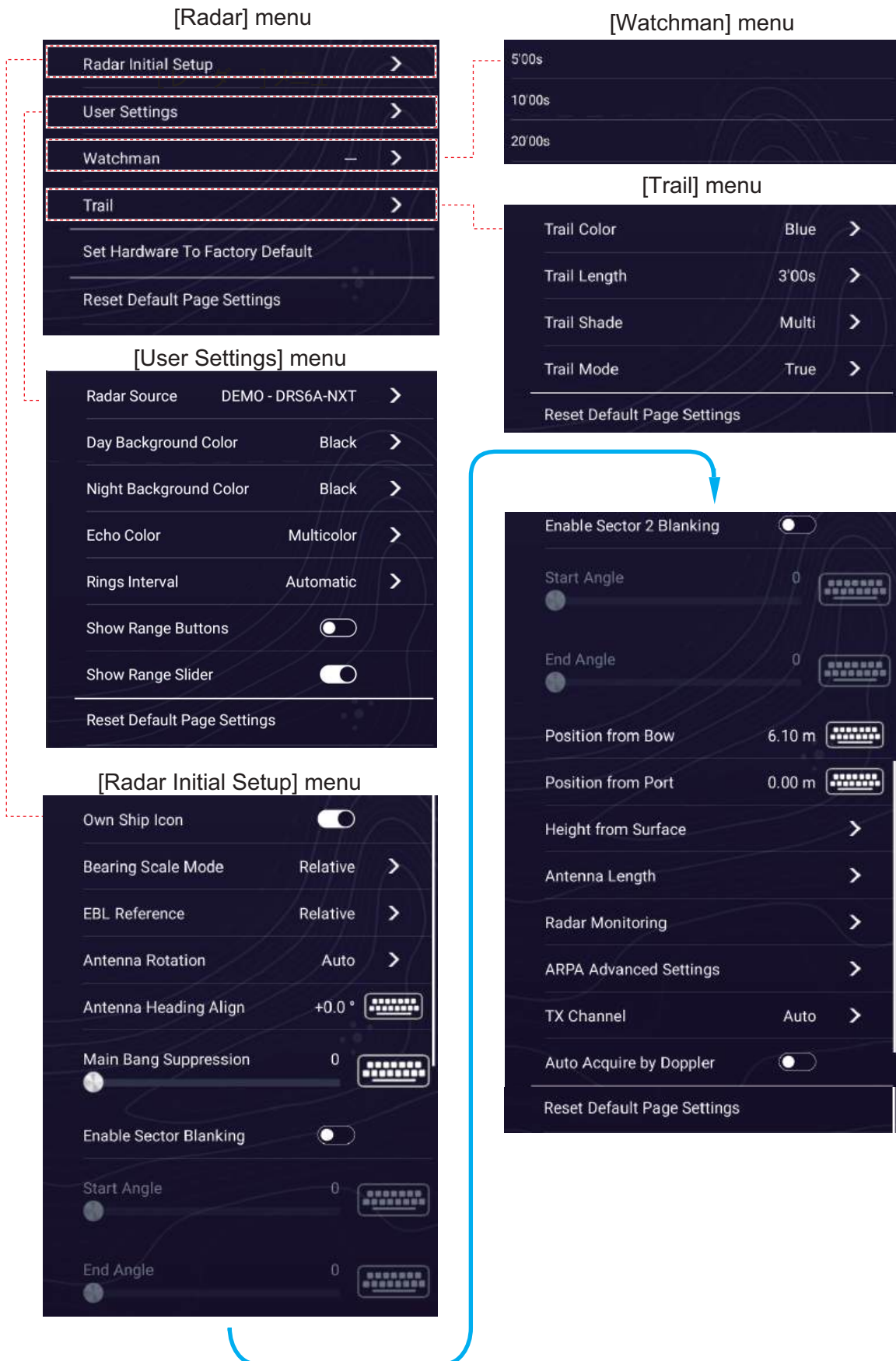

Radar Initial Setup menu

[Antenna Rotation]^{*1}: Starts or stop antenna rotation. For the service technician. See the installation manual.

[Antenna Heading Align]: Compensates for error in positioning of the antenna unit at installation. See the installation manual for the adjustment procedure.

[Main Bang Suppression]: Reduces main bang, the clutter appearing at the screen center. See the installation manual for the adjustment procedure.

[Enable Sector Blanking]: Sets the area(s) where to prevent transmission. For example, set the area where an interfering object at the rear of the antenna would produce a dead sector (area where no echoes appear) on the display. See the installation manual for the procedure.

[Position from Bow], **[Position from Port]**: Set the position of the radar antenna in relation to the bow and port.

[Height From Surface]^{*1}: Set the height of the radar antenna above the waterline.

[Antenna Length]^{*}: Set the antenna radiator length.

[Tuning Source]^{*1}.^{*2}: Selects which range to use for manual tuning in the dual display. [Range 1] (Near range), [Range 2] (Far range)

[Radar Monitoring]: Show various voltage levels, and ARPA data. For the service technician.

[Radar Optimization]: Automatically adjust magnetron and tuning for the connected radar.

[ARPA Advanced Settings]: Sets ARPA parameters. For the service technician. Do not change the settings.

[Reset Default Page Settings]: Reset the [Radar Initial Setup] menu settings to default.

^{*1}: Not shown with radar sensor DRS4DL+.

^{*2}: Not shown with radar sensor DRS6A/12A/25A-NXT.

Radar menu

[Set Hardware to Factory Default]: Reset the radar sensor settings in the [Radar] menu. For the service technician.

[Reset Default Page Settings]: Reset the [Radar] menu settings to default.

7.29 How to Interpret the Radar Display

7.29.1 False echoes

Echo signals can appear on the screen at positions where there is no target or disappear where there are targets. You can identify false targets when you understand why the false echoes appear. A description of false echoes follows.

Multiple echoes

Multiple echoes occur when a transmitted pulse returns from a solid object like a large ship, bridge, or breakwater. A second, a third or more echoes can be seen on the screen at two, three or more times the true range of the target as shown below. You can reduce and sometimes remove these multiple echoes if you decrease the gain, or correctly adjust the sea clutter.

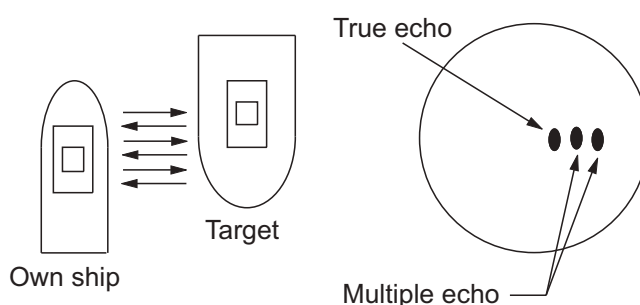

Virtual image

A large target near your ship can show at two positions on the screen. One of the positions is the true echo reflected by the target. The other position is a false echo which is caused by the "mirror effect" of a large object on or near your ship. See the figure shown below for an example of this type of false echo. If your ship gets near a large metal bridge, for example, a false echo appears on the screen. The echo disappears after move some distance from the bridge.

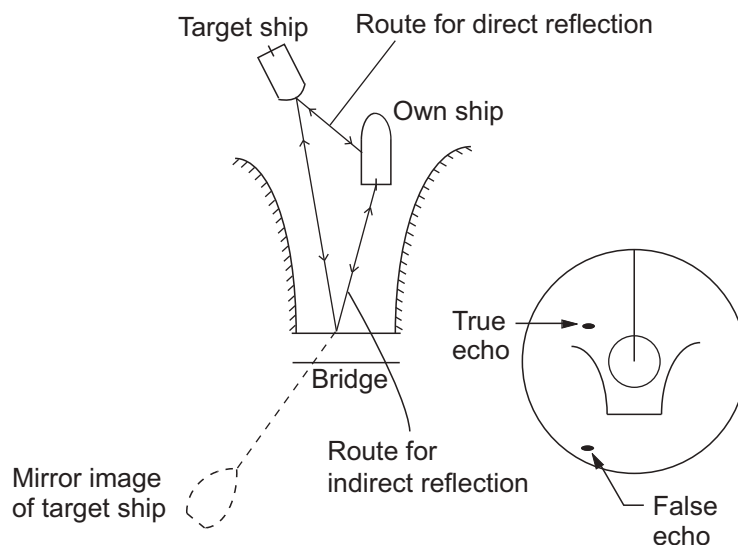

Sector blanking

Funnels, stacks, masts, or derricks in the path of the antenna stop the radar beam. If the angle opposite the antenna is more than one or two degrees, a sector or shadow sector appears on the screen. Targets are not displayed within the sector.

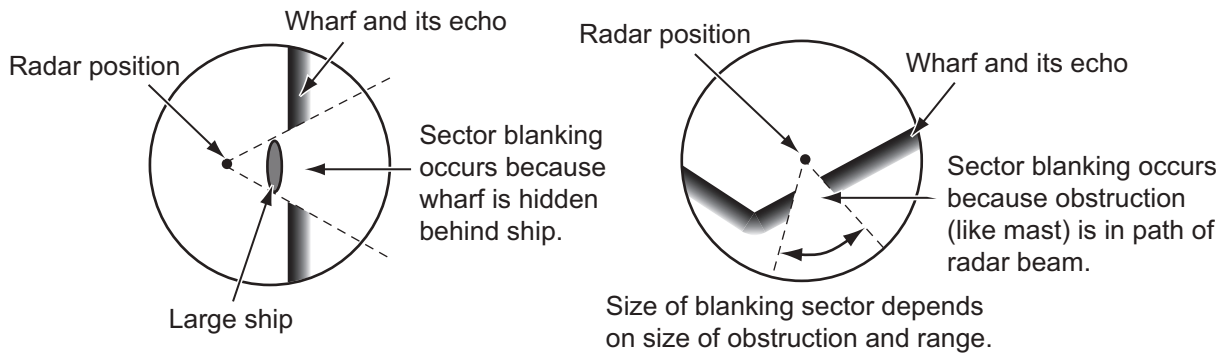

Sidelobe echoes

Each time the radar transmits, some radiation leaves on each side of the beam. This lost energy has the name "sidelobes" If a target is detected by both the sidelobes and the mainlobe, the sidelobe echoes can appear at both sides of the true echo at the same range. Sidelobes normally show only on short ranges and from strong targets. You can reduce sidelobes if you reduce the gain, or correctly adjust the sea clutter.

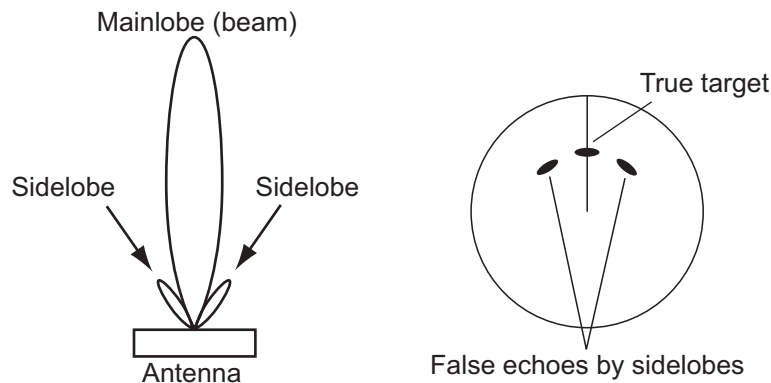

7.29.2 Search and rescue transponder (SART)

A ship in distress uses a radar-SART to show a series of dots on the radar display of nearby ships to indicate distress. A SART transmits when it receives a radar pulse from any X-Band (3 cm) radar within a range of approximately 8 nm. When a SART receives a radar pulse, the SART transmits a response across all the radar frequency band.

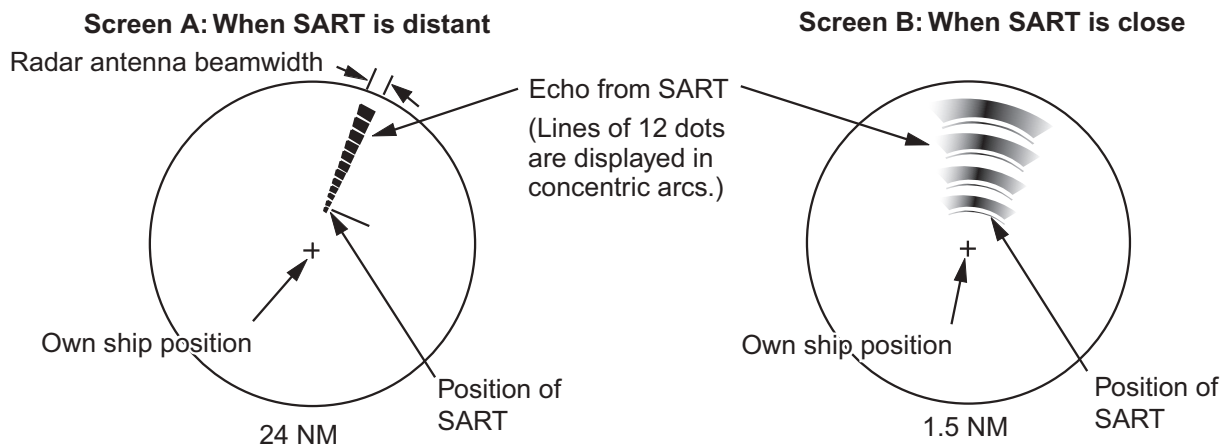

How to detect the SART response

- Use the range scale of 6 or 12 NM.
- Turn off all the automatic clutter filters.
- Turn off the interference rejector.

7.29.3 RACON (Radar Beacon)

A RACON is a radar transponder that sends a characteristic signal when the RACON receives a radar pulse (normally only the three-centimeter band). If the RACON signal is sent on the same frequency as that of the radar, the signal appears on the radar display. The RACON signal appears on the radar in one of two methods:

- A line that starts just after the position of the RACON
- A Morse code signal displayed with a line just after the position of the RACON.

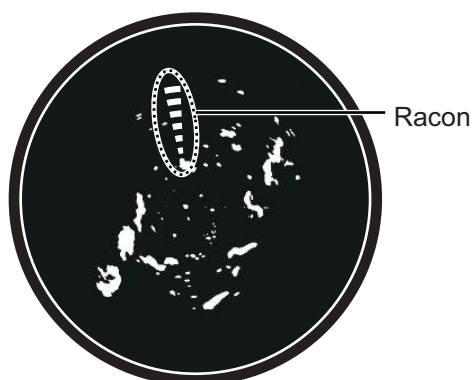

This page is intentionally left blank.

8. CHIRP SIDE SCAN

The CHIRP side scan display can be shown on the TZT9E/13Es screen with a NavNet TZtouch3 (excluding TZT9F) or NavNet TZtouchXL (TZT10X/13X/16X), or other TZT9E/13E units connected to a compatible CHIRP transducer. For the TZMAP9/13, the CHIRP side scan display can be shown on the TZMAP9/13 fish finder.

A chirp is a signal in which the frequency increases (up-chirp) or decreases (down-chirp) with time. CHIRP side scan uses this technology to display high-resolution, low-noise images. Since the bottom and fish schools are displayed separately, the chirp side scan mode is useful for making fishing decisions.

Note 1: The CHIRP side scan and DFF-3D side scan (see chapter 9) cannot be used at the same time (CHIRP side scan takes priority).

Note 2: To change the CHIRP side scan source (available for the TZT9E/13E only), open the [CHIRP Side Scan] menu (see section 8.2), tap [CHIRP Side Scan Source], then tap desired source.

Note 3: Do not use a dual-frequency CHIRP fish finder transducer and a CHIRP side scan transducer at the same time.

8.1 CHIRP Side Scan Display

Go to the Home page, then tap the CHIRP side scan icon to show the side scan display.

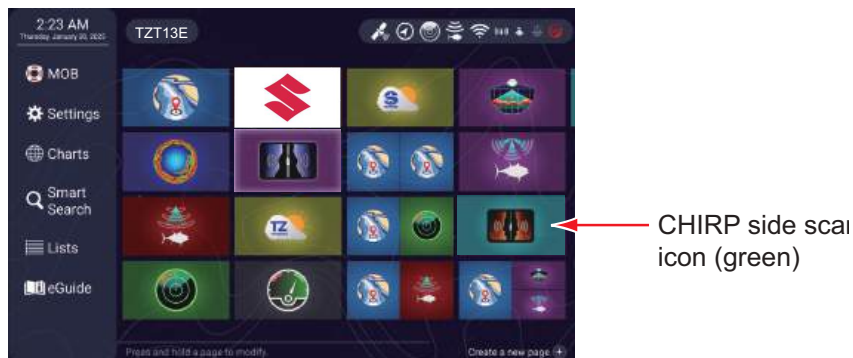

The CHIRP side scan display shows the echoes received from the port/starboard direction. The CHIRP side scan image begins at the center of the ship and is drawn towards port and starboard. The latest echo is displayed at the top of the screen, and the oldest echo appears at the bottom of the screen. Unlike other display modes, the CHIRP side scan image can clearly show the shape of a target (fishing reef, etc.).

8. CHIRP SIDE SCAN

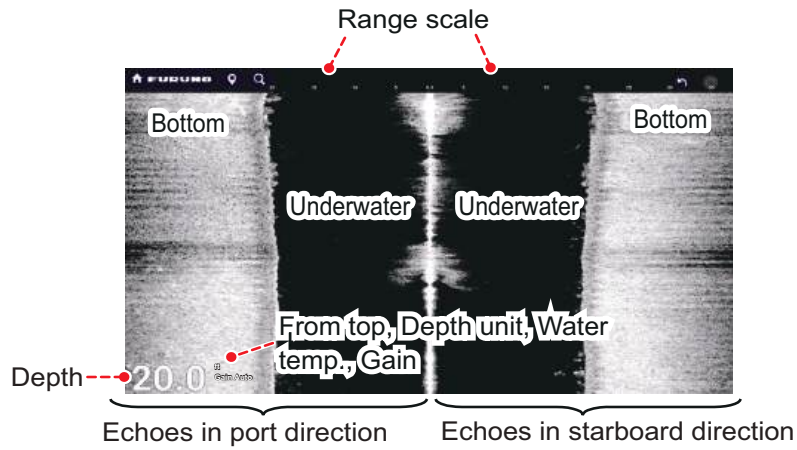

8.2 CHIRP Side Scan Menu

To display the [CHIRP Side Scan] menu, open the Layers menu, then tap [Settings], or Home page→[Settings]→[CHIRP Side Scan].

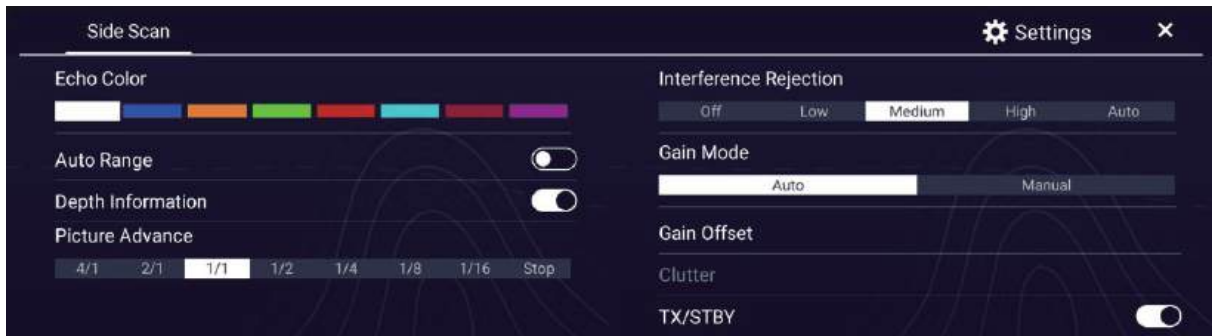

Layers menu for CHIRP Side Scan

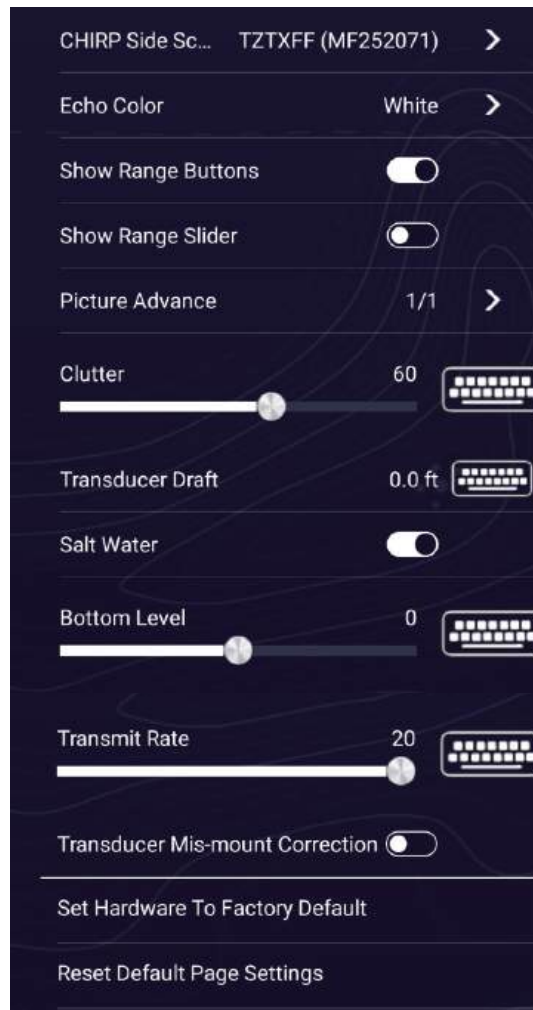

[CHIRP Side Scan] menu

See chapter 6 for the following items.

Menu item	Reference	Menu item	Reference
Interference Rejector	section 6.9	Salt Water	section 6.21
Clutter	section 6.7	Bottom Level	section 6.21
Transducer Draft	section 6.21	Transducer Mis-Mount Correction	Installation Manual

8.3 How To Start, Stop Transmission

On the Layers menu, turn [TX/STBY] on to transmit; or off to stop transmission. "Stand-by" appears at the center of the display when transmission is stopped.

8.4 How to Change the TX Rate

Change the TX rate for the CHIRP side scan as follows

1. Home page→[Settings]→[CHIRP Side Scan].
2. Operate the slider bar for [Transmit Rate] to set the transmit rate. The setting range is 0 to 20.
The smaller the display range, the faster the transmission speed, and the larger the display range, the slower the transmission speed.

3. Tap [×] on the title bar to finish and close the menu.

8.5 How to Change the Echo Color

Change the echo color for the CHIRP side scan as follows.

1. Home page→[Settings]→[CHIRP Side Scan].
2. Tap [Echo Color].
3. Select desired echo color, among [White], [Blue], [Brown], [Green], [Tuna Hunter], [Aqua Marine], [Fury], or [Volcano].
4. Tap [×] on the title bar to finish and close the menu.

[Echo Color] can also be changed from the Layers menu.

8.6 How to Change the Range

Range can be changed automatically or manually. To select the range mode, open the Layers menu, then turn [Auto Range] on or off.

On: The range is changed automatically to keep the bottom echo on the screen.

Off: Tap the range buttons (⊕, ⊖) to change the range.

8.7 How to Adjust the Gain

Gain can be adjusted automatically or manually.

Automatic adjustment

The automatic gain adjustment feature is convenient when you don't have the time to adjust the gain (for example, when you are busy with other tasks). With the automatic gain mode activated, gain, clutter, and TVG are automatically adjusted. The main functions of the automatic mode are as follows.

- The gain is automatically adjusted to show the bottom echo in appropriate color.
- The clutter function removes weak echoes such as noise and plankton.

To select an automatic gain adjustment mode, open the Layers menu, then set [Gain Mode] to [Auto].

In the [Auto] mode, the gain can still be adjusted. To set the appropriate value, open the Layers menu and tap [Gain Offset]. The slider bar appears at the right edge of the screen. Drag the slider thumb (circle) on the slider bar, tap the slider bar, or tap the (⊕, ⊖) buttons to adjust the gain. Tap [Done] at the top right-hand corner of the screen.

Manual adjustment

To select the manual gain adjustment mode, open the Layers menu, then set [Gain Mode] to [Manual]. Tap [Gain] to show the slider bar at the right edge of the screen.

Drag the slider thumb (circle) on the slider bar, tap the slider bar, or tap the (⊕, ⊖) buttons to adjust the gain. Tap [Done] at the top right-hand corner of the screen.

The gain controls how echoes of different strengths are displayed.

8.8 Depth/Water Temperature/Gain Display

You can show or hide the depth, water temperature, or gain displayed at the bottom left of the screen. To show or hide those indications, open the Layers menu, then turn the flip switch of [Depth Information] on or off.

Note: The text font size for depth/water temperature/gain can be adjusted.

- For full screen: [Fish Finder]→[User Settings]→[Digital Depth Size] menu.
- For split screen: [General]→[This Display]→[Scale & Layout] menu.

8.9 How to Change the Picture Advance Speed

You can change the picture advance speed for the CHIRP side scan display. The appearance of the images changes according to the picture advance speed, even for same-sized schools of fish and the bottom. A higher advance speed expands the image in the longitudinal direction, while a slower speed shrinks the image in the longitudinal direction. To observe a rugged bottom in detail, use a high picture advance speed. For a gentle bottom, decrease the speed to see slight undulations more clearly.

1. Home page→[Settings]→[CHIRP Side Scan].
2. Tap [Picture Advance].
3. Select desired picture advance speed.
[1/16] is the slowest speed, and [4/1] is the fastest. [1/16] means one scan line is produced for every 16 transmissions. [4/1] means four scan lines are produced for every transmission.
4. Tap [×] on the title bar to finish and close the menu.

[Picture Advance] can also be changed from the Layers menu.

8. CHIRP SIDE SCAN

This page is intentionally left blank.

9. MULTI BEAM SONAR DFF-3D (FOR TXT9E/13E ONLY)

The DFF-3D is a multi-beam sonar that displays underwater and ocean floor images with high precision. This chapter describes the various display screens available with the DFF-3D. The display screen includes multi-sounder, side scan, and cross section.

9.1 Menu Operations

This section covers the top layer of the [DFF-3D Multi Beam Sonar] menu. For details regarding menu operations with each of the displays, see the respective section.

Display	Section no.
Multi-Sounder	section 9.3
Side Scan	section 9.4
Cross Section	section 9.5

9.1.1 How to start/stop transmission

You can start/stop transmission from the menu.

1. Home page→[Settings]→[DFF-3D Multi Beam Sonar].
2. Turn [Multi Beam Sonar Transmit] on to transmit, off to stop transmission.

9.1.2 How set the background color

You can set the day and night background colors to suit your needs and preferences.

1. Home page→[Settings]→[DFF-3D Multi Beam Sonar].
2. Tap [Day Background Color] or [Night Background Color].



[Day Background Color] options

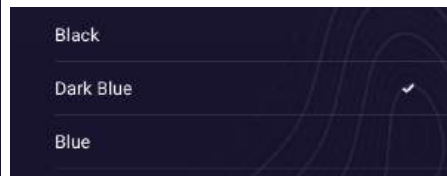

[Night Background Color] options

3. Tap the desired color.
4. Tap [x] on the title bar to finish and close the menu.

The [Day Background Color] can also be selected from the Layers menu, in the [Overlays] tab.

9.1.3 How to adjust the bottom range shift

The bottom range shift feature changes the location at which the seabed appears on the screen. This is particularly useful when the seabed is “off-screen”.

Note: This feature requires [Auto Range] to be active. See section 6.5.

1. Home page→[Settings]→[DFF-3D Multi Beam Sonar].
2. Use the software keyboard or the slider bar for [Bottom Range Shift Area] to adjust the value as required. The figure below shows some examples of how the settings affect the on-screen display. A lower value places the seabed at a higher location on-screen. A higher value places the seabed at a lower location on-screen.

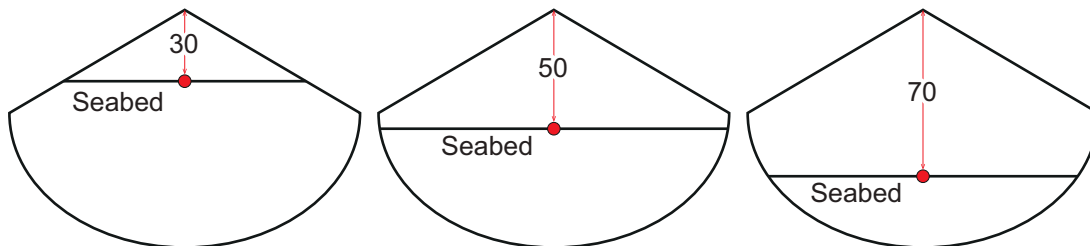

3. Tap [×] on the title bar to finish and close the menu.



9.1.4 How to change the TX rate

You can adjust the rate at which the sonar beam is transmitted using one of the three available settings. Each setting has distinct characteristics allowing for a broad range of applications.

Setting	Characteristics
[Manual]	Affected by the selected range. A shorter range has a faster transmission rate; a longer range has a slower rate.
[Auto]	Affected by vessel speed. Slow speeds have a slower transmission rate; high speeds have a faster rate. Note: Speeds of 20 kn or higher are fixed at a transmission rate of 20.
[Maximum]	Affected by detected depth. Shallows have a faster transmission rate; deeper waters have a slower rate. Note: Where the selected range exceeds the detected depth, the transmission rate may exceed 20.

1. Home page→[Settings]→[DFF-3D Multi Beam Sonar].
2. Tap [Transmit Rate Mode].
3. Tap [Manual], [Auto] or [Maximum] as required.
4. If you selected [Manual], use the slider bar or the software keyboard for [Transmit Rate Manual Value] to set the value (setting range: 0 to 20).
5. Tap [×] on the title bar to finish and close the menu.

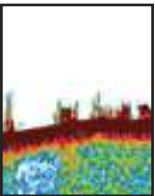
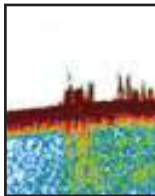
Note: The multi sounder echo display varies depending on the set transmit speed setting value.

Display Screen	Rate = 0	Rate = 10	Rate = 20
Multi-sounder			

9.2 Display Screens Overview

Multi-sounder display

Open the Home page, then tap the DFF-3D Multi-sounder icon to show the multi-sounder display.

The multi-sounder display operates similar to the conventional fish finder, providing information about the seabed and underwater conditions. The video display scrolls from right to left with the passing of time.

The echoes appearing at the right edge of the display are the latest echoes. Echoes from individual fish, schools of fish and the seabed are shown. With the gain set properly, the distance to the seabed appears on the screen. Past echoes can be displayed.

The gain, clutter suppressor and TVG are adjusted according to the mode selected, auto fishing or auto cruising. Manual adjustment of those controls is also possible.

The single beam presentation displays the information detected by the downward-looking beam. The triple beam presentation displays the information detected by the port beam, starboard beam, and downward-looking beam.

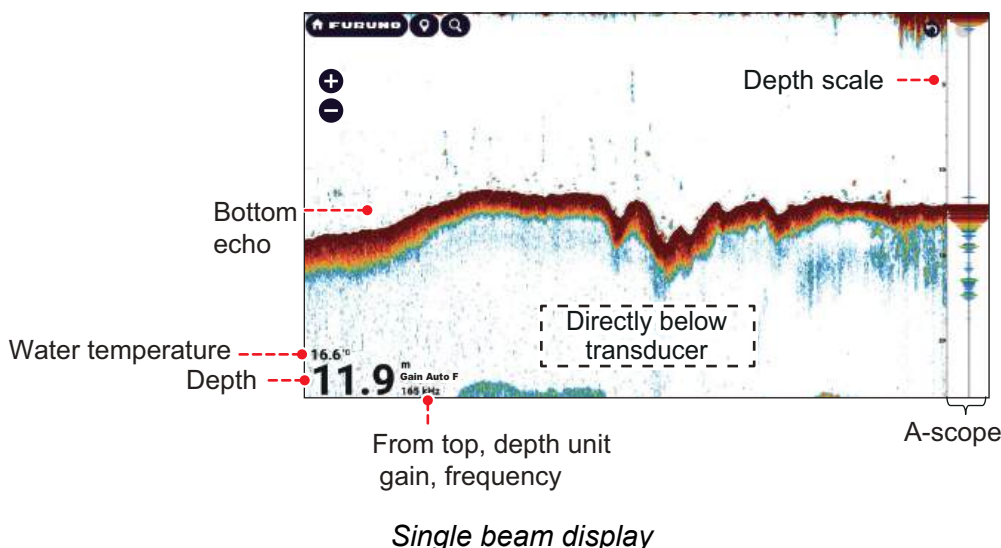

9. MULTI BEAM SONAR DFF-3D (FOR TXT9E/13E ONLY)

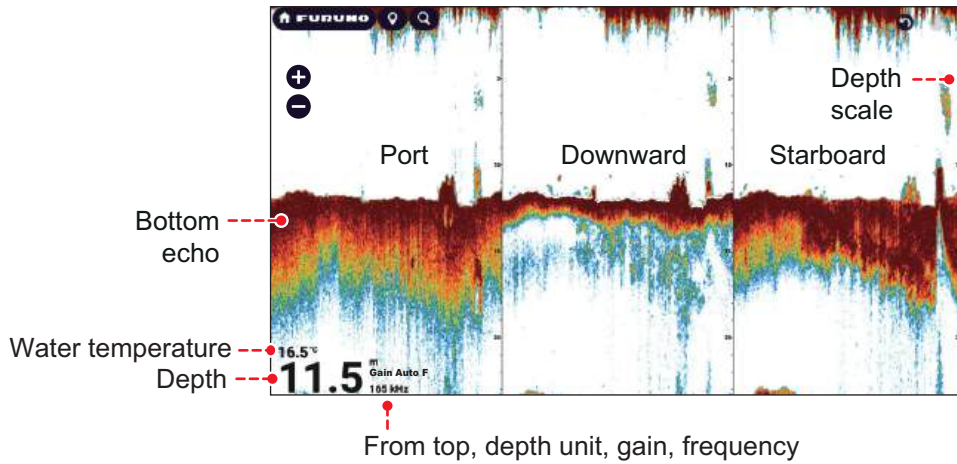

Triple beam display

Side scan display

Open the Home page, then tap the Side scan icon to show the side scan display.

The side scan display shows the echoes received from the port and starboard directions.

The display starts from the center of the vessel, and traces in the port and starboard directions. The most recent echoes are at the top of the display and the oldest are at the bottom of the screen.

The side scan display is different from the other modes employed by this equipment - it clearly displays the shape of echoes (fish bed, etc.).

Note: The DFF3D side scan is not selectable when the CHIRP side scan is use.

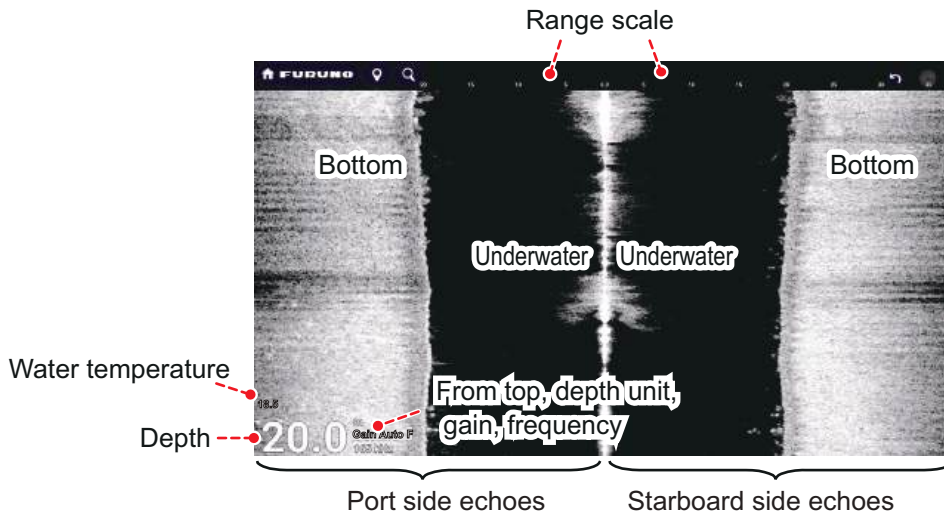

Side scan display

Cross section display

Open the Home page, then tap the Cross section icon to show the cross section display.

The cross section display shows seabed and underwater conditions.

This multi-beam sonar uses a 120° beam (downward to port 60°; downward to starboard 60°), providing highly accurate underwater images.

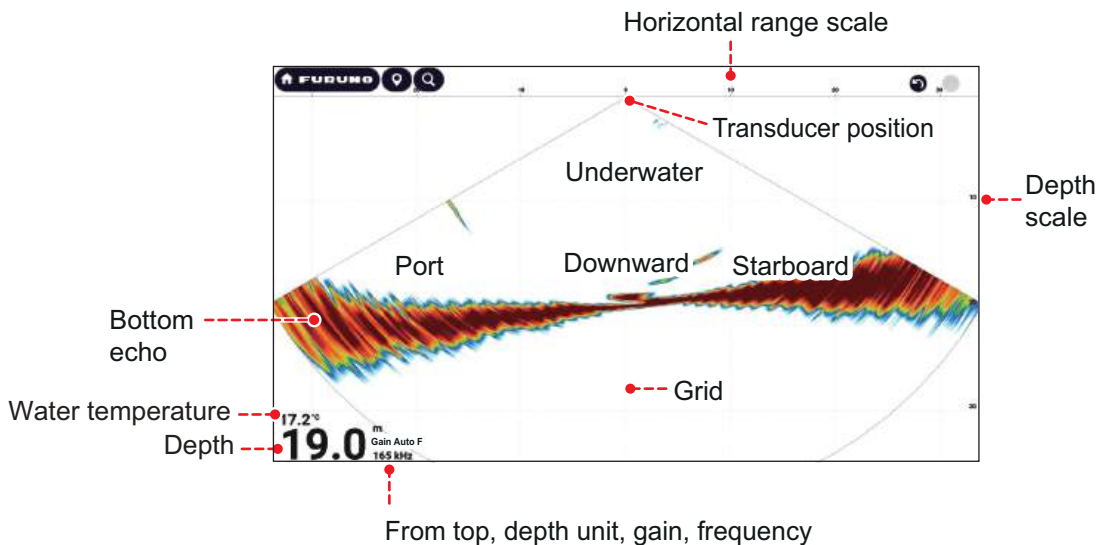
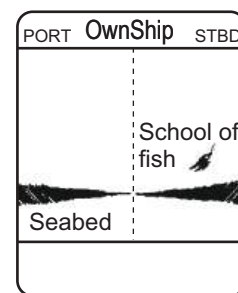
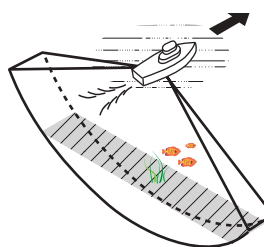

Cross section display

9.3 Multi-Sounder Display Operations

This section covers the functions available with the multi-sounder display. To show the [Multi-Sounder] menu, open the Layers menu, then tap the [Multi Beam] tab. The [Multi-Sounder] menu can also be accessed from the menu (Home page→[Settings]→[DFF-3D Multi Beam Sonar]→[Multi-Sounder]).

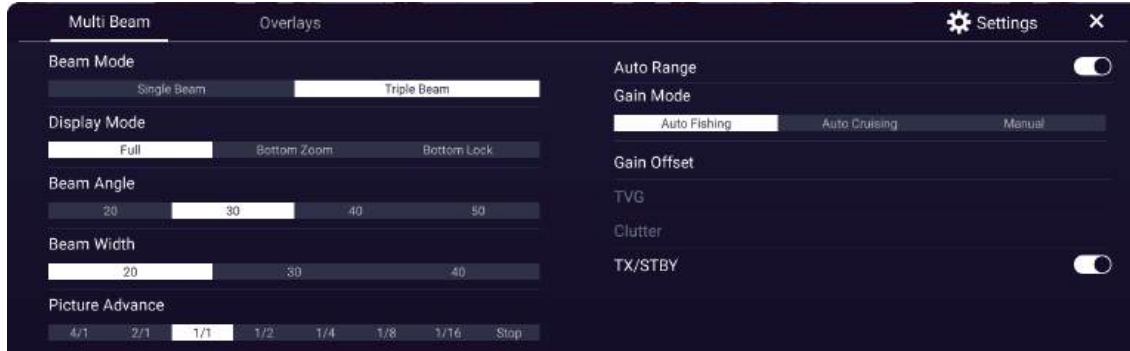

[Multi Beam] tab

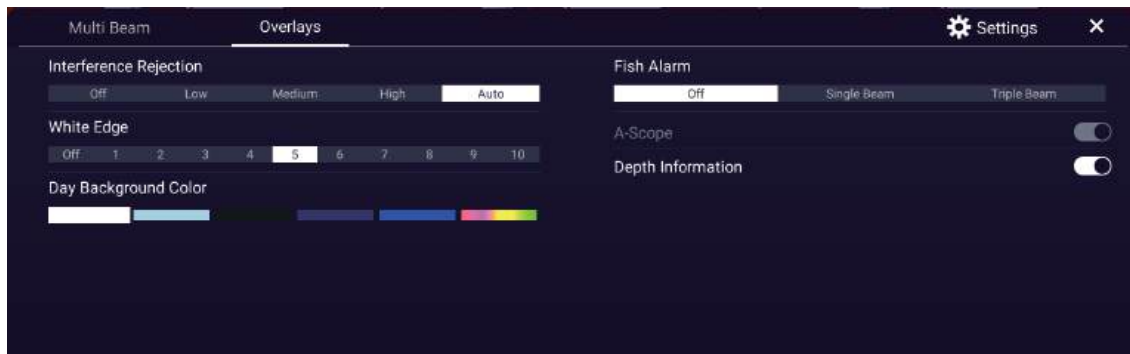

[Overlays] tab

Layers menus for multi-sounder display

9.3.1 How to switch between TX and STBY

Open the Layers menu, tap the [Multi Beam] tab, then use [TX/STBY] to start or stop transmission. "Stand-by" appears at the center of the screen when transmission is stopped.

9.3.2 How to switch between single beam and triple beam presentations

1. Open the Layers menu, then tap the [Multi Beam] tab.
2. Tap [Beam Mode], then tap [Single Beam] or [Triple Beam].

9.3.3 How to set the TX beam angle

You can set the TX beam angle for the port, starboard and downward beams.

1. Open the Layers menu, then tap the [Multi Beam] tab.
2. Tap [Beam Angle], then select a beam angle,

9.3.4 How to set the TX beam width

You can set the TX beam width for the port, starboard and downward beams.

1. Open the Layers menu, then tap the [Multi Beam] tab.
2. Tap [Beam Width], then select a beam width.

9.3.5 How to change the picture advance speed

The picture advance setting sets how quickly vertical scan lines move across the display. When viewing a seabed with sharp rises and falls, such as a reef-bed or submerged wreck, a fast advance speed helps to “smooth” out the seabed for easier viewing. On the other hand, when viewing a smooth seabed with little to no undulations, a slow advance speed helps to identify rises and falls.

Do the following to change the picture advance speed.

1. Home page→[Settings]→[DFF-3D Multi Beam Sonar]→[Multi-Sounder].
2. Tap [Picture Advance].
3. Select an advance speed to suit your requirements.
The default speed is [1/1] (normal speed), the fastest speed is [4/1] (four times normal speed) and the slowest speed is [1/8] (eight times slower than normal speed). Select [Stop] to stop the picture advance for closer examination and screenshots/photos.
4. Tap [×] on the title bar to finish and close the menu.

[Picture Advance] can also be changed from the Layers menu, in the [Multi Beam] tab.

9.3.6 How to change the display mode

In addition to the normal multi-sounder display, there is a “bottom zoom” display that enlarges and displays an image of a certain distance from the seabed, and a “bottom lock” display that enlarges and displays the area near the bottom. To change the display mode, do the following:

1. Open the Layers menu, then tap the [Multi Beam] tab.
2. At [Display Mode], tap [Full], then [Bottom Zoom] or [Bottom Lock].

9.3.7 How to show or hide the depth/water temperature/gain/frequency indications

You can show or hide the depth/water temperature/gain/TX frequency at the bottom left corner of the screen.

1. Open the Layers menu.
2. Turn [Depth Information] on or off.

Note: The text font size of the depth/water temp./gain/frequency can be adjusted.

- For full screen: [Fish Finder]→[User Settings]→[Digital Depth Size] menu.
- For split screen: [General]→[This Display]→[Scale & Layout] menu.

9.3.8 Fish alarm

The fish alarm warns you, with audio and visual alarms, when fish come into the preset alarm area. See section 6.14 for details.

1. Home page→[Settings]→[DFF-3D Multi Beam Sonar]→[Alarms].
2. Use the software keyboard for [Range Minimum Value] to set, then tap [✓]. The [Range Minimum Value] sets the start depth for the alarm.
3. Use the software keyboard for [Range Maximum Value] to set, then tap [✓]. The [Range Maximum Value] sets the end depth for the alarm.
4. Tap [Fish Alarm], then tap [Single Beam] (alarm for single beam display) or [Triple Beam] (alarm for triple beam display).
5. Tap [Fish Alarm Level], then select which echo strength triggers the alarm. For example, select [Low] to get the alarm for only low-strength echoes.
6. Tap [×] on the tile bar to finish and close the menu.

Step 4 can also be done from the Layers menu, with [Fish Alarm] in the [Overlays] tab.

9.3.9 How to manually adjust the gain

Do the following to adjust the gain manually.

1. Open the Layers menu.
2. On the [Multi Beam] tab, set [Gain Mode] to [Manual].
3. Tap [Gain]. If you have assigned gain adjustment to the two-finger (long) tap function (see section 1.16), instead of tapping [Gain] in the Layers menu, two-finger (long) tap the screen. You can still display the slider bar in step 4.
4. With the slider bar at the right edge of the screen, drag the slider thumb, tap the slider bar, or tap the +/− buttons to set the gain. See the figure on page 6-9.
5. Tap [End] at the top right corner.

9.3.10 Availability of points and event marks registration, and go to a point

For operation, see chapter 4.

The table below shows function availability according to latitude/longitude, heading data presence or absence. If there is no latitude/longitude data, none of the functions below are available.

Latitude/Longitude / Heading data: YES

Item	Starboard	Downward	Port
Point registration	Yes	Yes	Yes
Go to point	Yes	Yes	Yes
Event mark registration	Yes	Yes	Yes

Latitude/Longitude: YES. Heading data: NO

Item	Starboard	Downward	Port
Point registration	No	Yes	No
Go to point	No	Yes	No
Event mark registration	No	Yes	No

For starboard, downward, and port, see the illustration "Triple beam display" on page 9-4.

9.3.11 How to reset the Multi-Sounder menu settings to default

Do the following to reset the [Multi-Sounder] menu settings to default.

1. Home page→[Settings]→[DFF-3D Multi Beam Sonar]→[Multi-Sounder].
2. Tap [Reset Default Page Settings]. A confirmation message appears.
3. Tap [OK].
4. Tap [x] on the title bar to finish and close the menu.

9.4 Side Scan Display Operations

This section covers the functions available with the side scan display. For the menu items shared with the conventional fish finder, see chapter 6. To show the [Side Scan] menu, open the Layers menu, or from the Home page, tap [Settings]→[DFF-3D Multi Beam Sonar]→[Side Scan].

Note: The network-installed NavNet TZtouch3 w/side scan (see Chapter 8) and the DFF-3D side scan cannot be used at the same time (the NavNet TZtouch3 takes precedence).

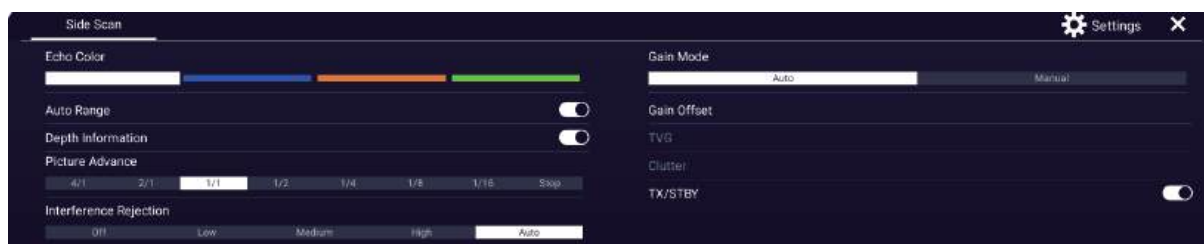

Layers menu for side scan display

9.4.1 How to switch between TX and STBY

Open the Layers menu. then operate the [TX/STBY] flipswitch to start, stop transmission. "Stand-by" appears at the center of the screen when transmission is stopped.

9.4.2 How to change echo color

You can select the echo color as follows.

1. Home page→[Settings]→[DFF-3D Multi Beam Sonar]→[Side Scan].
2. Tap [Echo Color].
3. Select [White], [Blue], [Brown], [Green], [Tuna Hunter], [Aqua Marine], [Fury], or [Volcano].
4. Tap [x] on the title bar to finish and close the menu.

You can also select the echo color from the Layers menu.

9.4.3 How to change the range

Range can be changed automatically or manually. To select the range mode, open the Layers menu, then set turn the [Auto Range] flipswitch on or off.

On: The range is changed automatically to keep the bottom echo on the screen.

Off: Tap the range buttons (⊕, ⊖) to change the range.

9.4.4 How to change the picture advance speed

You can change the picture advance speed for the side scan display. The appearance of the images changes according to the picture advance speed, even for same-sized schools of fish and the bottom. A higher advance speed expands the image in the longitudinal direction, while a slower speed shrinks the image in the longitudinal direction. To observe a rugged bottom in detail, use a high picture advance speed. For a gentle bottom, decrease the speed to see slight undulations more clearly.

Do the following to change the picture advance speed.

1. Home page→[Settings]→[DFF-3D Multi Beam Sonar]→[Side Scan].
2. Tap [Picture Advance].
3. Select an advance speed to suit your requirements.
The default speed is [1/1] (normal speed), the fastest speed is [4/1] (four times normal speed) and the slowest speed is [1/8] (eight times slower than normal speed). Select [Stop] to stop the picture advance for closer examination and screenshots/photos.
4. Tap [×] on the title bar to finish and close the menu.

The picture advance speed can also be changed from the Layers menu.

9.4.5 How to show or hide the depth/water temperature/gain/frequency indications

You can show or hide the depth, water temperature, gain, and TX frequency at the bottom left corner of the screen.



1. Open the Layers menu.
2. Turn the [Depth Information] flipswitch on or off.

Note: The text font size of the depth/water temp./gain/frequency can be adjusted.

- For full screen: [Fish Finder]→[User Settings]→[Digital Depth Size] menu.
- For split screen: [General]→[This Display]→[Scale & Layout] menu.

9.4.6 How to manually adjust the gain

Do the following to manually adjust the gain.

1. Open the Layers menu.
2. Set [Gain Mode] to [Manual].
3. Tap [Gain]. If you have assigned gain adjustment to the two-finger (long) tap function (see section 1.16), instead of tapping [Gain] in the Layers menu, two-finger (long) tap the screen. You can still display the slider bar in step 4.
4. With the slider bar at the right edge of the screen, drag the slider thumb, tap the slider bar, or tap the / buttons to set the gain. See the figure on page 6-9
5. Tap [End] at the top right corner.

9.4.7 Availability of points and event marks registration, and go to a point

For how to register points and event marks, see chapter 4.

The table below shows function availability according to latitude/longitude, heading data presence or absence. If there is no latitude/longitude data, none of the functions below are available.

Latitude/Longitude / Heading data: YES

Item	Starboard	Port
Point registration	Yes	Yes
Go to point	Yes	Yes
Event mark registration	Yes	Yes

Latitude/Longitude: YES. Heading data: NO

Item	Starboard	Port
Point registration	No	No
Go to point	No	No
Event mark registration	Yes (registered at the center)	

9.4.8 How to reset the Side Scan menu settings to default

Do the following to reset the [Side Scan] menu settings to default.

1. Home page→[Settings]→[DFF-3D Multi Beam Sonar]→[Side Scan].
2. Tap [Reset Default Page Settings]. A confirmation message appears.
3. Tap [OK].
4. Tap [×] on the tile bar to finish and close the menu.

9.5 Cross Section Display Operations

This section covers the functions available with the cross section display. For the menu items shared with the conventional fish finder, see chapter 6. To show the [Cross Section] menu, open the Layers menu, or from the Home page, tap [Settings]→[DFF-3D Multi Beam Sonar]→[Cross Section].



Layers menu for cross section display

9.5.1 How to switch between TX and STBY

Open the Layers menu, then use the [TX/STBY] flipswitch to start, stop transmission. "Stand-by" appears at the center of the screen when transmission is stopped.

9.5.2 How to show or hide the grid

The grid, which is useful for measuring the distance to a target, can be shown or hidden as follows.

1. Open the Layers menu.
2. Turn the [Grid] flipswitch on or off.

9.5.3 Zoom display

The seabed echo can be zoomed.

1. Open the Layers menu.
2. Turn the [Zoom] flipswitch on (zoom display) or off (normal display).

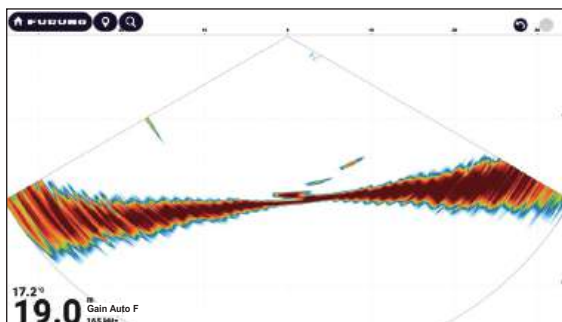

[Zoom] selected

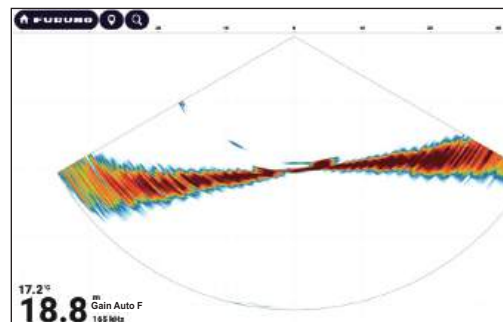

[Zoom] not selected

9.5.4 How to smooth echoes (distance)

If echoes are "disconnected" because of an undulating seabed, change the setting to [Low], [Medium] or [High] as necessary. Smoothing is done in the range direction to smooth the echo presentation.

1. Home page→[Settings]→[DFF-3D Multi Beam Sonar]→[Cross Section].
2. Tap [Echo Smoothing (Distance)].
3. Select [Low], [Medium] or [High]. The default setting is [Medium]. Select [Off] to cancel smoothing.
4. Tap [×] on the title bar to finish and close the menu.

9.5.5 How to smooth echoes (time)

If echoes are difficult to see because they appear "speckled," use the echo smoothing feature to suppress the speckling by time.

1. Home page→[Settings]→[DFF-3D Multi Beam Sonar]→[Cross Section].
2. Tap [Echo Smoothing (Time)].
3. Select [Low], [Medium] or [High]. The default setting is [Medium]. Select [Off] to cancel smoothing.
4. Tap [×] on the title bar to finish and close the menu.

9.5.6 How to apply correction to the speed of sound

If the echoes appear patchy and difficult to see, set echo smoothing to [Low], [Medium], or [High]. This has the effect of smoothing the time frame and eliminating speckled echoes.

Manual correction

1. Home page→[Settings]→[DFF-3D Multi Beam Sonar]→[Cross Section].
2. At [Sound Speed Correction], set the correction value with the software keyboard or the slider thumb. The setting range is -200 to 200.
3. Tap [×] on the title bar to finish and close the menu.

Automatic correction

The speed of sound is automatically corrected based on the water temperature

1. Home page→[Settings]→[DFF-3D Multi Beam Sonar]→[Cross Section].
2. Turn on [Temperature.Based Correction].
3. Tap [×] on the title bar to finish and close the menu.

9.5.7 How to show or hide the depth/water temperature/gain/frequency indications

You can show or hide the depth, water temperature, gain and TX frequency at the bottom left corner of the screen.

1. Open the Layers menu.
2. Turn [Depth Information] on or off.

Note: The text font size of the depth/water temp./gain/frequency can be adjusted.

- For full screen: [Fish Finder]→[User Settings]→[Digital Depth Size] menu.
- For split screen: [General]→[This Display]→[Scale & Layout] menu.

9.5.8 How to manually adjust the gain

Do the following to manually adjust the gain.

1. Open the Layers menu.
2. Set [Gain Mode] to [Manual].
3. Tap [Gain]. If you have assigned gain adjustment to the two-finger (long) tap function (see section 1.16), instead of tapping [Gain] in the Layers menu, two-finger (long) tap the screen. You can still display the slider bar in step 4.
4. With the slider bar at the right edge of the screen, drag the slider thumb, tap the slider bar, or tap the **+**/**-** buttons to set the gain. See the figure on page 6-9
5. Tap [End] at the top right corner.

9.5.9 Availability of points and event marks registration, and go to a point

For how to register points and event marks, see section 4.2.

The table below shows function availability according to latitude/longitude, heading data presence or absence. If there is no latitude/longitude data, none of the functions below are available.

Latitude/Longitude / Heading data: YES

Item	Cross section
Point registration	Yes
Go to point	No
Event mark registration	Yes

Latitude/Longitude: YES. Heading data: NO

Item	Cross section
Point registration	No
Go to point	No
Event mark registration	Yes

9.5.10 How to reset the Cross Section menu settings to default

Do the following to reset the [Cross Section] menu settings to default.

1. Home page→[Settings]→[DFF-3D Multi Beam Sonar]→[Cross Section].
2. Tap [Reset Default Page Settings]. A confirmation message appears.
3. Tap [OK].
4. Tap [×] on the tile bar to finish and close the menu.

10. CSH-10 SCANNING SONAR (TZT9E/13E ONLY)

The CSH-10 Color Scanning Sonar is a full-circle electronic scanning sonar that displays underwater conditions. The CSH-10 is connected to this unit via LAN (only one unit can be connected) to display sonar images.

10.1 Sonar Display

Tap the sonar display icon on the Home page.

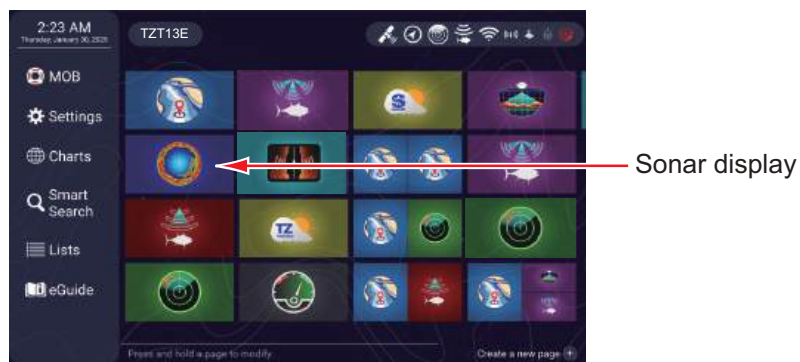

The sonar display shows underwater information in all directions around the vessel, showing underwater conditions such as schools of fish, seabed, and casted nets. 85 kHz high-frequency transmission makes it easy to identify schools of fish on the rapids and seabed. The sharp beam width is effective for detecting fish schools on water surface.

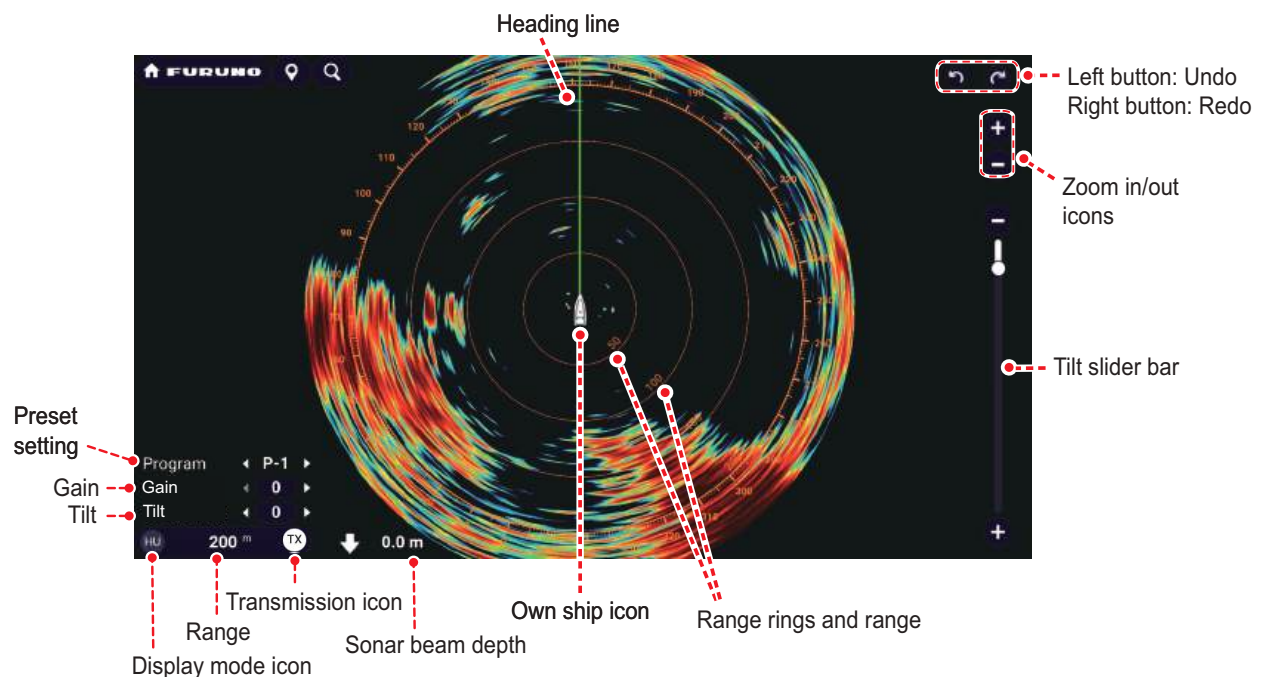

10.2 Sonar Menu

To display the [Sonar] menu, open the Layers menu and tap [Settings] at the top-right corner, or select [Settings]→[Sonar] from the Home page. In this manual, this operation is described as "Open the [Sonar] menu".

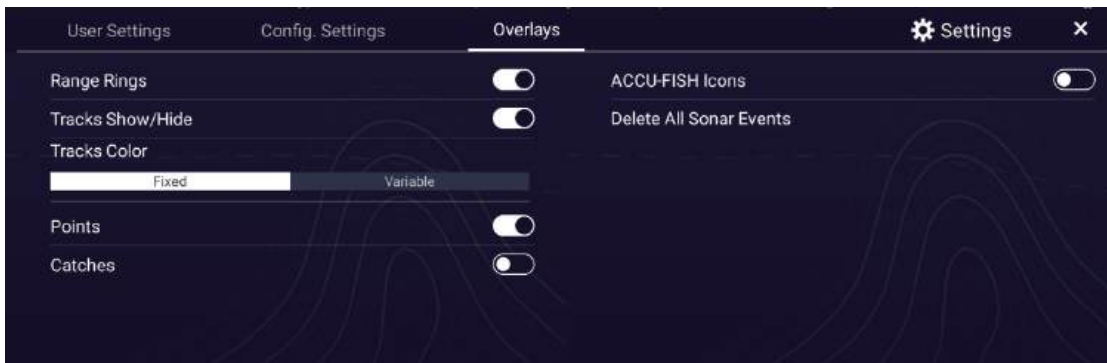
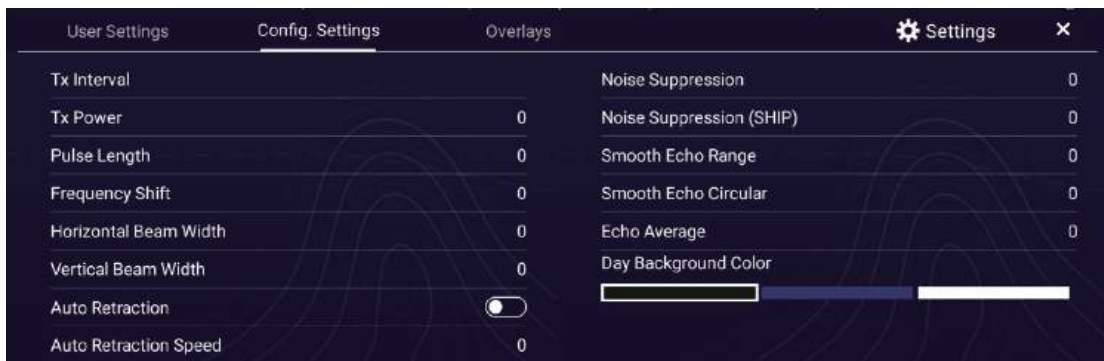

Sonar display layers menu

[Sonar] menu

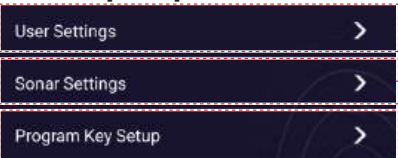

[User Settings]



[Sonar Settings]



← [Scan Setting 2] options are the same as [Scan Setting 1].



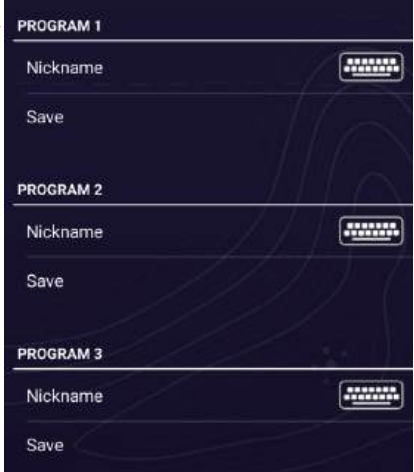

[Program Key Setup]



← Max. ten program setups available.



[Sonar] menu

10.3 How to Protrude and Retract the Transducer

 DANGER	 CAUTION
 <p>Keep away from raise/lower shaft in hull unit when it is moving.</p> <p>Gears in hull unit will cause serious injury.</p>	<p>Check the water depth before lowering the transducer.</p> <p>If the depth is too shallow, the transducer may touch the seabed, resulting in damage to the transducer.</p>
	<p>Do not transmit the transducer when it is out of water (for example, when dry-docked), to prevent damage to the transducer.</p>



To lower the transducer, open the Layers menu→[User Settings] tab→[Protrude]→ then tap [OK]. To start the transmission, refer to section 10.4 and switch to the transmit state.

To retract the transducer, open the Layers menu→[User Settings] tab→[Retract]→ then tap [OK]. To stop the transmission, refer to section 10.4 and switch to the standby state.

 CAUTION
 <p>If the system (or the network connection) is turned off while the transducer is protruding, the transducer will rise urgently. For safety reasons, retract the transducer before turning off the power. If multiple TZT9E/13Es' are connected, transducer emergency rises when all the systems are turned off.</p>

Automatic retract function

The CSH-10 automatic retract function automatically retracts the transducer when the ship's speed exceeds the set value.

 CAUTION
 <p>In all cases, always reduce the ship speed to less than 20 knots (18 knots before/while raising and retracting the transducer) when using this unit. Exceeding the speed may damage the equipment, resulting in an accident. When the automatic retract function is [ON] (default arrangement), the transducer may be retracted if the actual ship speed exceeds the set speed.</p>

Method 1: Set from the [Sonar] menu

1. Open the [Sonar] menu.
2. Tap [Sonar Settings].
3. Tap [Auto Retraction].
4. Use the [Auto Retraction Speed] slider bar (or the software keyboard) and set the ship speed value for retraction.
5. Tap [×] on the title bar to close the menu.

Method 2: Set from the Layers menu

1. Open the Layers menu.
2. Tap the [Config.Settings] tab and set the [Auto Retraction] to on.
3. Tap the [Auto Retraction Speed].
4. With the slider bar at the right edge of the screen, drag the slider thumb or tap the (⊕, ⊖) buttons to set the ship speed value (refer to page 6-10 figure).
5. Tap [Done] at the top-right corner of the screen to finish.

10.4 How to Switch to Transmission/Standby State

Note: Transmission automatically stops once the transducer starts raising.

Method 1: Set from the [Sonar] menu

1. Open the [Sonar] menu.
2. Tap [Sonar Settings].
3. Set the [TX/STBY] to on (transmit) or off (standby).
4. Tap [x] on the title bar to close the menu.

Method 2: Set from the Layers menu

Open the Layers menu→[User Settings]→set the [TX/STBY] to on (transmit) or off (standby).

10.5 How to Adjust the Gain

Do the following to adjust the gain manually.

Method 1: Set on the sonar display

Tap ◀ or ▶ of the [Gain] shown at the bottom left corner of the screen and set the gain value.

Method 2: Set from the Layers menu

1. Open the Layers menu.
2. Tap the [User Settings] tab, then tap [Gain].
3. With the slider bar at the right edge of the screen, drag the slider thumb, tap the slider bar, or tap the (⊕, ⊖) buttons to set the gain value (refer to page 6-10 figure).
4. Tap [Done] at the top-right corner of the screen to finish.

10.6 How to Adjust Near Gain/Far Gain

Echoes from targets such as the bottom and fish return to the transducer in order of the distance to them, and when we compare their intensities at the transducer face, those from nearer targets are generally stronger when their reflecting properties are nearly equal. The sonar operator will be quite inconvenienced if these echoes are directly shown on the display, since the actual size of the target cannot be judged from the size of echoes displayed.

The proper gain in an area within 300 m to suppress unwanted echoes and noise can be set for both [Near Gain] and [Far Gain].

Method 1: Set from the [Sonar] menu

1. Open the [Sonar] menu.
2. Tap [User Settings].
3. Use the [Near Gain], or [Far Gain] slider bar (or the software keyboard) and set the gain value.
4. Tap [×] on the title bar to close the menu.

Method 2: Set from the Layers menu

1. Open the Layers menu.
2. Tap the [User Settings] tab, then tap [Near Gain] or [Far Gain].
3. With the slider bar at the right edge of the screen, drag the slider thumb, tap the slider bar, or tap the (●,●) buttons to set the gain value (refer to page 6-10 figure).
4. Tap [Done] at the top-right corner of the screen to finish.

10.7 How to Suppress Bottom Tail

Schools of fish (echoes) located near the bottom are sometimes difficult to detect because you have to discriminate them from the bottom reflections. With [AGC Near], [AGC Far], or [Tx Pulse Length] used properly, the tail of bottom reflections is decreased, making it easier to discriminate bottom fish.

10.7.1 How to set AGC near/far

The AGC reduces the receiver gain only against strong echoes such as the bottom or a large school of fish. Since weak echoes remain unaffected, a small school of fish becomes easier to detect. Adjust the AGC properly so it works only on bottom reflections.

Method 1: Set from the [Sonar] menu

1. Open the [Sonar] menu.
2. Tap [User Settings].
3. Use the [AGC Near], or [AGC Far] slider bar (or the software keyboard) and set the AGC value.
4. Tap [×] on the title bar to close the menu.

Method 2: Set from the Layers menu

1. Open the Layers menu.
2. Tap the [User Settings] tab, then tap [AGC Near] or [AGC Far].
3. With the slider bar at the right edge of the screen, drag the slider thumb, tap the slider bar, or tap the (⊕, ⊖) buttons to set the AGC value (refer to page 6-10 figure).
4. Tap [Done] at the top-right corner of the screen to finish.

10.7.2 How to set pulse length

When searching bottom fish, it is useful to shorten the pulse length in order to separate fish echoes from bottom reflections.

Note: To search the surface fish or midwater fish in which bottom reflections are not so strong, the longest pulse length [10] should be used.

Method 1: Set from the [Sonar] menu

1. Open the [Sonar] menu.
2. Tap [User Settings].
3. Use the [Tx Pulse Length] slider bar (or the software keyboard) and set the pulse length value.
4. Tap [x] on the title bar to close the menu.

Method 2: Set from the Layers menu

1. Open the Layers menu.
2. Tap the [Config. Settings] tab, then tap [Pulse Length].
3. With the slider bar at the right edge of the screen, drag the slider thumb, tap the slider bar, or tap the (⊕, ⊖) buttons to set the pulse length value (refer to page 6-10 figure).
4. Tap [Done] at the top-right corner of the screen to finish.

10.7.3 How to suppress the unwanted echoes

Removing or suppressing noise from weak echoes such as sea clutters, planktons, distant sea bottoms, or propeller noise can help you clear the display. The noise suppression function adjusts the gain level for weak echoes only, leaving schools of fish echoes unaffected.

Method 1: Set from the [Sonar] menu

1. Open the [Sonar] menu.
2. Tap [User Settings].
3. Tap [Noise Suppression].
4. Select noise suppression value.
5. Tap [<] on the title bar to move back to the [User Settings] menu.
6. Use the [Noise Suppression (SHIP)] slider bar (or the software keyboard) and set the noise suppression value.

10. CSH-10 SCANNING SONAR (TZT9E/13E ONLY)

7. Tap [×] on the title bar to close the menu.

Method 2: Set from the Layers menu

1. Open the Layers menu.
2. Tap the [Config. Settings] tab, then tap [Noise Suppression] or [Noise Suppression (SHIP)].
3. With the slider bar at the right edge of the screen, drag the slider thumb, tap the slider bar, or tap the (⊕, ⊖) buttons to set the noise suppression value (refer to page 6-10 figure).
4. Tap [Done] at the top-right corner of the screen to finish.

10.8 How to Set the Transmission Power

Method 1: Set from the [Sonar] menu

1. Open the [Sonar] menu.
2. Tap [User Settings].
3. Use the [Tx Power] slider bar (or the software keyboard) and set the transmission power value.
4. Tap [×] on the title bar to close the menu.

Method 2: Set from the Layers menu

1. Open the Layers menu.
2. Tap the [Config. Settings] tab, then tap [Tx Power].
3. With the slider bar at the right edge of the screen, drag the slider thumb, tap the slider bar, or tap the (⊕, ⊖) buttons to set the transmission power value (refer to page 6-10 figure).
4. Tap [Done] at the top-right corner of the screen to finish.

10.9 How to Reject Sonar Interference and Noise

Noise and interference are mostly caused by on-board electronic equipment, engine, propeller noise, or electrical noise from other sonars being operated on other ships nearby.

10.9.1 How to reject noise with the interference rejector

Reject random noise, sea clutter in rough sea conditions, and noise from other sounders with the interference rejector as follows.

Method 1: Set from the [Sonar] menu

1. Open the [Sonar] menu.
2. Tap [User Settings].
3. Tap [Interference Rejector 1]. The [Interference Rejector 1] rejects random noise and sea clutter in rough sea conditions.

4. Select [Weak] or [Strong]. [OFF] turns off the interference rejector.
5. Tap [<] on the title bar to move back to the [User Settings] menu.
6. Use the [Interference Rejector 2] slider bar (or the software keyboard) and set the interference rejector 2 value.
The higher the setting, the greater the degree of interference rejection. [0] turns off the interference rejector.
7. Tap [×] on the title bar to close the menu.

Method 2: Set from the Layers menu

1. Open the Layers menu.
2. Tap the [Config. Settings] tab, then tap [Weak] or [Strong] for the [Interference Re-jector 1]. [OFF] turns off the interference rejector.
3. Tap [Interference Rejector 2].
4. With the slider bar at the right edge of the screen, drag the slider thumb, tap the slider bar, or tap the (⊕, ⊖) buttons to set the interference rejector 2 value (refer to page 6-10 figure).
5. Tap [Done] at the top-right corner of the screen to finish.

10.9.2 How to reject noise with the noise limiter

Weak, unwanted echoes, colored light blue or green, are displayed when water is murky, plankton layers exist, or there is ship's noise. Reject these types of noise with the noise limiter as follows.

Method 1: Set from the [Sonar] menu

1. Open the [Sonar] menu.
2. Tap [User Settings].
3. Use the [Noise Limiter] slider bar (or the software keyboard) and set the noise lim-iter value. The higher the setting, the greater the noise limiter effect.
4. Tap [×] on the title bar to close the menu.

Method 2: Set from the Layers menu

1. Open the Layers menu.
2. Tap the [User Settings] tab, then tap [Noise Limiter].
3. With the slider bar at the right edge of the screen, drag the slider thumb, tap the slider bar, or tap the (⊕, ⊖) buttons to set the noise limiter value (refer to page 6-10 figure).
4. Tap [Done] at the top-right corner of the screen to finish.

10.9.3 How to set the transmission interval

When other ships with a sonar of the same transmission frequency as own sonar are near, "rings" of interference may appear. To reject this interference, adjust the transmission interval setting as follows.

Method 1: Set from the [Sonar] menu

1. Open the [Sonar] menu.
2. Tap [User Settings].
3. Tap [TX Interval].
4. Select one of the following transmission intervals.
 - [Fixed 1] to [Fixed 9]: Sets the transmission interval. The lower the setting, the longer the transmission interval.
 - [Random 1] to [Random 4]: Changes the cycle for each transmission. This prevents interference from being received at the same time. The larger the value, the greater the degree of change in the transmission cycle.
 - [External SYNCH]: Synchronizes the intervals with the signal input from an external source.
5. Tap [×] on the title bar to close the menu.

Method 2: Set from the Layers menu

1. Open the Layers menu.
2. Tap the [Config. Settings] tab, then tap [Tx Interval].
3. With the slider bar at the right edge of the screen, drag the slider thumb, tap the slider bar, or tap the (⊕, ⊖) buttons to set the transmission interval value (refer to page 6-10 figure).
4. Tap [Done] at the top-right corner of the screen to finish.

10.9.4 How to shift the transmission frequency

If the interference can not be suppressed by the interference rejector, or change in transmission interval, shift the transmission frequency as follows.

Method 1: Set from the [Sonar] menu

1. Open the [Sonar] menu.
2. Tap [User Settings].
3. Use the [Frequency Shift] slider bar (or the software keyboard) and set the frequency shift value.
4. Tap [x] on the title bar to close the menu.

Method 2: Set from the Layers menu

1. Open the Layers menu.
2. Tap the [Config. Settings] tab, then tap [Frequency Shift].
3. With the slider bar at the right edge of the screen, drag the slider thumb or tap the (⊕, ⊖) buttons to set the frequency shift value (refer to page 6-10 figure).
4. Tap [Done] at the top-right corner of the screen to finish.

10.9.5 How to adjust echo average

The echo average function adjusts echo afterglow - the amount of time an echo signal remains on the display. This feature can be useful for watching echo movement. Adjust the setting so that targets are clearly visible on the display.

Method 1: Set from the [Sonar] menu

1. Open the [Sonar] menu.
2. Tap [User Settings].
3. Use the [Echo Average] slider bar (or the software keyboard) and set the echo average value.
 - Setting range 0: Turns off the echo average function.
 - Setting range 1 to 7: Echoes are gradually displayed and afterglow remains on the display longer as the setting is increased. This setting range is effective for removing the unwanted echoes that randomly appear on the display such as sea clutter.
 - Setting range 8 to 11: Echoes appear quickly, and the higher the value, the longer the afterglow remains on the screen. Adjust the setting so that the targeted fish are easy to see.
4. Tap [x] on the title bar to close the menu.

Method 2: Set from the Layers menu

1. Open the Layers menu.
2. Tap the [Config. Settings] tab, then tap [Echo Average].
3. With the slider bar at the right edge of the screen, drag the slider thumb or tap the (⊕, ⊖) buttons to set the echo average value (refer to page 6-10 figure).
4. Tap [Done] at the top-right corner of the screen to finish.

10.10 How to Adjust Beamwidth

Unwanted echoes can be suppressed by adjusting the width of the horizontal beam and vertical beam.

Method 1: Set from the [Sonar] menu

1. Open the [Sonar] menu.
2. Tap [User Settings].
3. Use the [Horizontal Beam Width], or [Vertical Beam Width] slider bar (or the software keyboard) and set the echo average value.
 - [Horizontal Beam Width]: The higher setting narrows the horizontal beamwidth. This is useful to discriminate weak echoes.
 - [Vertical Beam Width]: The higher setting narrows the vertical beamwidth. This is useful to discriminate fish echoes near the sea bottom.
4. Tap [X] on the title bar to close the menu.

Method 2: Set from the Layers menu

1. Open the Layers menu.
2. Tap the [Config. Settings] tab, then tap [Horizontal Beam Width], or [Vertical Beam Width].
3. With the slider bar at the right edge of the screen, drag the slider thumb or tap the (◀, ▶) buttons to set the beam width value (refer to page 6-10 figure).
4. Tap [Done] at the top-right corner of the screen to finish.

10.11 How to Remove Weak Echoes

You can remove weak echoes according to strength to clear the picture.

Method 1: Set from the [Sonar] menu

1. Open the [Sonar] menu.
2. Tap [User Settings].
3. Use the [Signal Level] slider bar (or the software keyboard) and set the signal level. With the higher setting, the weaker echoes are removed first.
4. Tap [X] on the title bar to close the menu.

Method 2: Set from the Layers menu

1. Open the Layers menu.
2. Tap the [User Settings] tab, then tap [Signal Level].
3. With the slider bar at the right edge of the screen, drag the slider thumb or tap the (◀, ▶) buttons to set the signal level (refer to page 6-10 figure).
4. Tap [Done] at the top-right corner of the screen to finish.

10.12 How to Set Smooth Echo

Set the level for smooth echo range and smooth echo circular to show the echoes smoothly on the screen as follows.

Method 1: Set from the [Sonar] menu

1. Open the [Sonar] menu.
2. Tap [User Settings].
3. Use the [Smooth Echo Range], or [Smooth Echo Circular] slider bar (or the software keyboard) and set the level.
With the higher setting, the echo is shown smoother.
4. Tap [x] on the title bar to close the menu.

Method 2: Set from the Layers menu

1. Open the Layers menu.
2. Tap the [Config. Settings] tab, then tap [Smooth Echo Range], or [Smooth Echo Circular].
3. With the slider bar at the right edge of the screen, drag the slider thumb or tap the (+, -) buttons to set the level (refer to page 6-10 figure).
4. Tap [Done] at the top-right corner of the screen to finish.

10.13 Tilt Angle

The tilt angle shows the angle from the sea surface at which the sound wave is emitted. When the sound wave is emitted horizontally, it is said to be zero (0) degrees, and when emitted vertically, 90 degrees.

10.13.1 How to set the tilt angle

Tap ◀ or ▶ under of the [Tilt] at the bottomleft corner of the screen to set the tilt angle. Set a smaller angle (about 5°) for water surface fish schools, and a larger angle for schools of fish in deep waters.

10.13.2 How to turn automatic tilt on/off

The automatic tilt function automatically tilts the transducer within the tilt range selected on the menu. This function is useful for finding center of a school of fish.

Note: This function is disabled while the target lock is active, or the transducer is being retracted.

1. Open the [Sonar] menu.
2. Tap [Sonar Settings].
3. Set [Auto Tilt] to on.
4. Use the [Auto Tilt Upper End], or [Auto Tilt Lower End] slider bar (or the software keyboard) and set the automatic tilt range (ranges within upper and lower ends).

10. CSH-10 SCANNING SONAR (TZT9E/13E ONLY)

- Adjust the automatic tilt settings if necessary as follows.
 - Refer to the following table and use the [Auto Tilt Angle] slider bar (or the software keyboard) to set the automatic tilt angle.
 - Refer to the following table and use the [Auto Tilt TX Count] slider bar (or the software keyboard) to set the automatic tilt transmission count.

	[Auto Tilt Angle]	[Auto Tilt TX Count]
If you want to search the auto tilt range in detail.	Decrease the value.	Increase the value.
If you want to search for fast swimming fish.	Increase the value	Decrease the value

The tilt speed changes according to the value set above.

- Tap [×] on the title bar to close the menu.

10.14 How to Adjust the Heading Line

Adjust the heading line as follows.

- Open the [Sonar] menu.
- Tap [Sonar Settings].
- Use the [Heading Align] slider bar (or the software keyboard) and adjust the heading.
- Tap [×] on the title bar to close the menu.

10.15 Background Color

The background color of the sonar screen can be changed according to daytime or nighttime conditions.

- Open the Layers menu.
- Tap the [Config. Settings] tab and select the color for [Day Background Color], or [Night Background Color].

10.16 How to Restore Scan Settings (Range, Tilt Angle, Gain)

The range, tilt angle, and gain set for scanning can be restored to its preset value. There are two ways to set the presets.

- Open the [Sonar] menu.
- Tap [Sonar Settings].
- To change range, select [Reset Range 1] or [Reset Range 2]. Select one of the following options.
 - OFF: To keep the current range after restoring the settings.
 - ON: The setting is restored to the set [Range Distance 1] value selected below.

4. To change the tilt angle, select [Reset tilt 1] or [Reset tilt 2]. Select one of the following options.
 - OFF: To keep the current tilt angle after restoring the settings.
 - ON: The setting is restored to the set [Reset tilt Angle 2] value selected below by using the slider bar (or the software keyboard).
5. To change the gain, select [Reset Gain 1] or [Reset Gain 2]. Select one of the following options.
 - OFF: To keep the current gain after restoring the settings.
 - ON: The setting is restored to the set [Reset Gain Value 1] value selected below by using the slider bar (or the software keyboard).
6. Tap [x] on the title bar to close the menu.

10.16.1 How to restore the settings for scanning

To restore the range, tilt angle, and gain settings, do as follows.

Note: This function is disabled when the auto tilt function is active while the [Reset Tilt 1] or [Reset Tilt 2] is set to other than off.

1. Open the [Sonar] menu.
2. Tap [Sonar Settings].
3. Select [Reset Scan Setting 1] or [Reset Scan Setting 2]. The setting values are restored to what was set in subsection 10.13.1.
4. Tap [x] on the title bar to close the menu.

10.17 Program Settings

The program settings provides for instant setup of the equipment according to fishing ground or target fish. Up to ten programs may be set up.

10.17.1 How to register preset setting

1. 1Set the display appropriately according to the fishing ground or target fish.
2. Open the [Sonar] menu.
3. Tap [Program Key Setup].
4. Tap any of the nicknames from [Program 1] to [Program 10] to display the software keyboard.
5. Enter the nickname, then tap [✓].
6. Tap [Save].
7. Tap [x] on the title bar to close the menu.

10.17.2 How to recall program settings

Method 1: Set from the [Sonar] menu

Select [P1] to [P10] from the [Program] at the bottom left corner of the screen.

Method 2: Set from the Layers menu

1. Open the Layers menu.
2. Tap the [User Settings] tab, then select [P1] to [P10] from the [Program].

10.18 Display On/Off Settings

In the [Overlays] tab of the Layers menu, you can choose to display or not display the range rings, tracks, points, catches, and ACCU-FISH icons on the sonar screen. Select [Fixed] or [Variable] for tracks color (see section 2.13.4).

10.19 Sonar Event Mark

Maximum of 20 event marks can be registered on the sonar screen.

Note: The registered event marks are erased every time when the power of the CSH-10 is turned off.

10.19.1 How to register an event mark

There are two ways to register sonar event marks. The shape of the mark differs depending on the registration method, and up to 20 marks can be registered for each method, for a total of 40 marks.

Method 1: Tap on the sonar screen

1. Tap the location on the sonar screen where you want to set the sonar event mark to display the pop-up menu.
2. Tap [Sonar Event]. The event mark icon (📍) is shown.
3. Repeat step 1 and step 2 to register all sonar event marks.

The newest mark is always displayed as 📍 icon, and older

marks are displayed as 📍 icons. Marks other than the newest are numbered at the top-right corner of the mark, 1, 2, 3..., 19, starting with the newest. When the number exceeds 20, the oldest mark is automatically deleted in the order of oldest to newest.

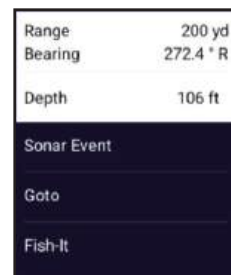

Range	200 yd
Bearing	272.4 ° R
Depth	106 ft
Sonar Event	
Goto	
Fish-It	

Method 2: Long tap on the sonar screen

1. On the sonar screen, long-tap the location where you want to set the sonar event mark. An icon (📍) appears at the long-tapped position.
2. Repeat step 1 to register all sonar event marks. The newest mark is always displayed as 📍 icon, and older marks are displayed as 📍 icons. Marks other than the newest are numbered at the bottom right corner of the mark, 1, 2, 3..., 19, starting with the newest. When the number exceeds 20, the oldest mark is automatically deleted in the order of oldest to newest.

10.19.2 How to show sonar event marks in the data box

Up to three sonar event information can be displayed in the data box. Refer to section 1.9.2 or section 10.9.3 to add/modify the Sonar Event History in the data box. The information shown on the right is displayed.



	RANGE	BEARING	DEPTH
⊗	649yd	175°	0.0
⊕	674yd	174°	0.0

10.19.3 How to delete event marks

Delete individually

Tap the event mark to show the pop-up display and then tap [Delete].

Delete all event marks

Open the [Overlays] tab on the Layers menu, then tap [Delete All Sonar Events].

10.20 How to Navigate Points

You can navigate by setting a destination to a location specified on the sonar screen (see section 4.16.2 and section 4.16.4 for details). Tap the location you wish to set as the destination on the sonar screen, then tap [Goto] from the pop-up menu. If the NAVpilot-300 or NAVpilot-1000 is connected to the monitoring system, a confirmation message will appear asking you to select a navigation mode, followed by the choice of NAVpilot Precision Mode, NAVpilot Economy Mode, or Hand Steer.

To set a sonar event mark (see section 10.19) as a destination, tap the sonar event mark, then tap [GoTo] from the pop-up menu.

To stop navigating, tap the [STOP] icon on the navigation bar at the top of the screen.

10.21 Fish-It Selection

The Fish-It function can be used on the sonar screen (see section 2.21 for details). Tap the location where you wish to fish on the sonar screen, and then tap [Select Destination] from the pop-up menu. A fish symbol icon will appear at the destination, tap to display the pop-up menu, and then tap [Fish-It].

To use the Fish-it function with sonar event mark (see section 10.19) set as the destination, tap the sonar event mark, and then tap [Fish-It] from the pop-up menu. To stop, tap the fish icon to display the pop-up menu, and then tap [Stop Fish-It].

10. CSH-10 SCANNING SONAR (TZT9E/13E ONLY)

This page is intentionally left blank.

11. FILE OPERATIONS

Points, routes, boundaries, tracks, photos, catch logs, and setting data (backup, import) can be imported and exported to a USB flash memory. Additionally, with a My TIMEZERO™* account, you can save settings data to the My TIMEZERO™ data service cloud. The card slot at the left side of the MFD holds microSD cards, and is for use with chart cards data. The slot cannot be used for reading or writing data.

The table below outlines the media that can be used with your unit.

Action	MicroSD card (Using SD card converter adapter)	USB flash memory (Type-C)
Export data	Yes	Yes
Import data	Yes	Yes

Note: For care and handling of MicroSD cards, see section 1.11.2.

Handling USB flash memory

- The media should be 32GB or less, formatted to file system FAT32.
- Do not use a secure USB flash memory.
- Turn off the power before inserting or removing the media connected to the USB port, to prevent corruption of data.
- A bootable USB flash memory may not be recognized correctly by this equipment. If not recognized, use a SD card formatter to format the USB flash memory.

11.1 Files Menu

To open the [Files] menu, Home page→[Settings]→[Files].

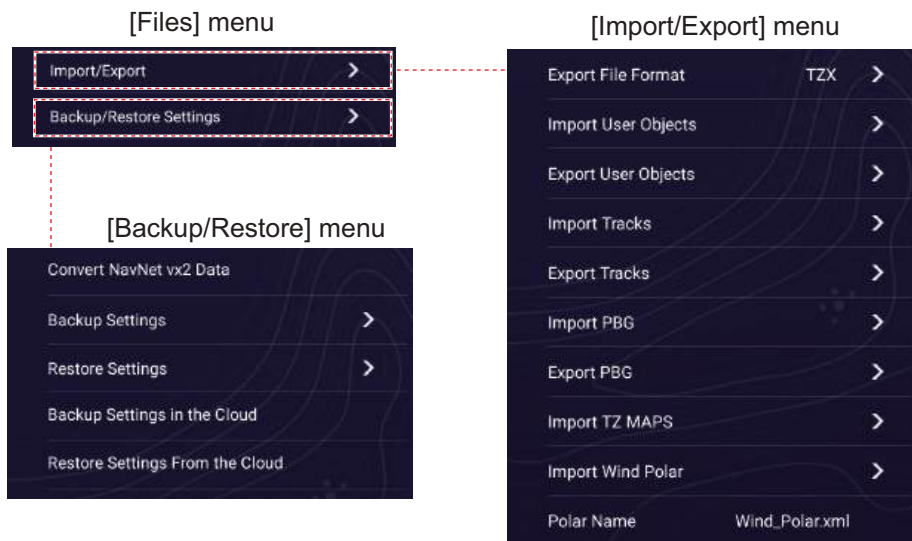

11.2 How to Set the Export Format

You can select the file format used for exporting to recording media as follows.

1. Home page→[Settings]→[Files]→[Import/Export].
2. Tap [Export File Format].
3. Tap desired file format, among [TZX], [TZD], [CSV], [GPX].
[TZX]: For TZMAP9/13, TZT9E/13E, NavNet TZtouch3, NavNet TZtouchXL
[TZD]: For NavNet TZtouch2
[CSV]^{*1}: For NavNet3D
[GPX]^{*2}: For PC plotter

^{*1}: The CSV format has the following capacity restrictions:

- Points: Max. 2,000
- Routes: Max. 200 (100 points/route)
- Track: Max. 10,000
- Symbol: Max. 32 types

^{*2}: When exporting data in GPX format, it is recommended to make a note of the data contained in the file. GPX files names do not indicate their contents.

4. Tap [x] on the title bar to finish and close the menu.

11.3 How to Export User Objects

The internal memory saves user object data (30,000 points, 200 routes, 100 polygons and lines (boundaries), 100 circles (boundaries), 1,000 photos, 1,000 catches). Once each data reaches its storage capacity, no more data can be saved. If you want to export all data to a recording media, do as follows.

1. Put a formatted media in the USB port.
2. Home page→[Settings]→[Files]→[Import/Export].
3. Tap [Export User Objects].
4. Tap the export destination. A message asks if you are sure to proceed.
5. Tap [OK]. The message "EXPORT SUCCEEDED" appears if the exporting was successful.
6. Tap [OK] to erase the message.
7. Tap [x] on the title bar to finish and close the menu.

11

11.4 How to Import User Objects

You can import user object data to the internal memory of this unit.

1. Put the media containing the user objects in the USB port.
2. Home page→[Settings]→[Files]→[Import/Export].
3. Tap [Import User Objects]. A list of files contained in the media appears.

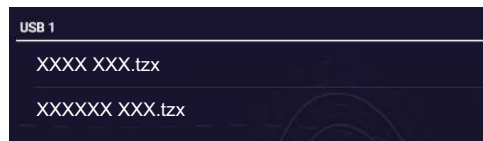

4. Tap the file to import. You are asked if you are sure to proceed.
5. Tap [OK]. The message "IMPORT SUCCEEDED" appears if the importing was successful.
6. Tap [OK] to erase the message.
7. Tap [x] on the title bar to finish and close the menu.

11.5 How to Export Tracks

1. Put a formatted media in the USB port.
2. Home page→[Settings]→[Files]→[Import/Export].
3. Tap [Export Tracks].
4. Tap the export destination for the track. You are asked if you are sure to proceed.
5. Tap [OK]. The message "EXPORT SUCCEEDED" appears if the exporting was successful.
6. Tap [OK] to erase the message.
7. Tap [x] on the title bar to finish and close the menu.

11.6 How to Import Tracks

You can import the tracks stored on a media to the internal memory of this unit.

Note: Imported tracks cannot be shared among TZMAP9/13 or TZT9E/13E units in the network. You must import tracks to each unit in the network.

1. Put the media containing the track in the USB port.
2. Home page→[Settings]→[Files]→[Import/Export].
3. Tap [Import Tracks] to show a list of tracks stored in the media.

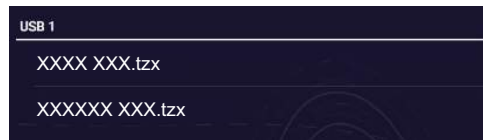

4. Tap the tracks file to import. You are asked if you are sure to proceed.
5. Tap [OK]. The message "IMPORT SUCCEEDED" appears if the exporting was successful.
6. Tap [OK] to erase the message.
7. Tap [x] on the title bar to finish and close the menu.

11.7 How to Export Equipment Settings

Equipment settings can be exported to a recording media. This is useful when you want to share the same settings among other units.

1. Put a formatted media in the USB port.
2. Home page→[Settings]→[Files]→[Backup/Restore Settings].
3. Tap [Backup Settings].
4. Tap the export destination for the settings data. You are asked if you are sure to proceed. The message "EXPORT SUCCEEDED" appears if the exporting was successful.
5. Tap [OK] to erase the message.
6. Tap [x] on the title bar to finish and close the menu.

11.8 How to Import Equipment Settings

You can import equipment settings from an appropriate media to this unit, and share them with the TZT9E/13E units in the NavNet network.

1. Put the media containing the equipment settings in the USB port
2. Home page→[Settings]→[Files]→[Backup/Restore Settings].
3. Tap [Restore Settings]. A list of settings data stored on the card in the media appears.



4. Tap the file to import. You are asked if you are sure to proceed.

5. Tap [OK]. The message "IMPORT SUCCEEDED" appears if the importing was successful.
6. Tap [OK] to erase the message.
7. Tap [×] on the title bar to finish and close the menu.

11.9 My TIMEZERO Cloud Data Service

With the TIMEZERO™ cloud data service, you can share data (settings, points, routes and tracks) stored in your TIMEZERO™ cloud account with another TZT9E/13E. To use the TIMEZERO™ cloud data service, connect to the internet and create a TIMEZERO™ account.

11.9.1 How to export data to the cloud

Do as follows to export data to the TIMEZERO™ cloud.

1. Home page→[Settings]→[My TIMEZERO].
2. Tap [Login] to login to your TIMEZERO™ account.
3. Tap [<] on the title bar to return to the [Settings] menu.
4. Tap [Files]→[Backup/Restore Settings]→[Backup Settings in the Cloud].
If the file already exists in the cloud, you are informed that the file exists and are you sure to proceed. Tap [OK] to write over the file in the cloud.
5. Tap [×] on the title bar to finish and close the menu.

11.9.2 How to restore data from the cloud

Do as follows to restore data from the cloud.

1. Home page→[Settings]→[My TIMEZERO].
2. Tap [Login] to login to your TIMEZERO™ account.
3. Tap [<] on the title bar to return to the [Settings] menu.
4. Tap [Files]→[Backup/Restore Settings]→[Restore Settings From the Cloud].
You are asked if you are sure to proceed.
5. Tap [OK] to write over data in this unit.
If there is no data file on the cloud, a message saying "No settings backed up" appears. Tap [OK] to delete the message.
6. Tap [×] on the title bar to finish and close the menu.

11.10 How to Convert NavNet vx2 Data

NavNet vx2 data (points, routes, tracks) can be converted for use with TZMAP9/13 or TZT9E/13E. Save the data to a USB flash memory, then do as follows.

1. Put the appropriate media in the USB port.
2. Tap Home page→[Settings]→[Files]→[Backup/Restore Settings]→[Convert NavNet vx2 Data]. The message "YOUR APPLICATION WILL RESTART AFTER THE CONVERSATION. DO YOU WANT TO CONVERT OLD DATA" appears.

11. FILE OPERATIONS

3. Tap the [OK] button. The system restarts and upon completion the [Data Converter] window appears.

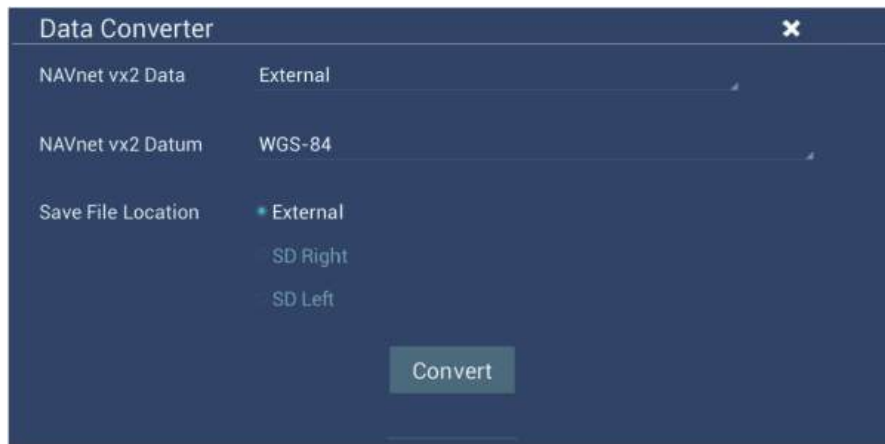

4. Select the location of the source data [External] at [Navnet vx2 Data].
5. At [Navnet vx2 Datum], select the geographical datum under which to convert the data. Typically, WGS-84.
6. At [Save File Location], select where to save the converted files, [External] for the USB port.
7. Tap the [Convert] button to convert the data. Tracks, points, and routes are converted and saved to separate .cvs files. You can now import the data files (see section 11.4).

12. FUSION-Link

The FUSION-Link™ product from FUSION Entertainment allows compatible TZMAP9/13 or TZT9E/13E displays to interface and control specialized FUSION marine entertainment equipment. The following FUSION-Link™ products are compatible with the TZMAP9/13 or TZT9E/13E, as of 12/2025.



Series name	Model
750 series	MS-AV750, MS-UD750
755 series	MS-AV755, MS-UD755
Apollo series	MS-RA770, MS-SRX400

Note 1: The Apollo series units have a built-in Wi-Fi, however connect the unit to the LAN of TZMAP9/13 or TZT9E/13E. The PartyBus™ feature of the Apollo is inoperative with the multi function display.

Note 2: For audio output, a speaker (locally arranged) must be connected to a FUSION-Link™ compatible device.

12.1 FUSION Display

The FUSION display (full screen) can be accessed by using the two-finger (long) tap function.

Note: See section 1.16 for how to set up the two-finger (long) tap function.

: Zones 1 and 2 volumes synched.
 : Zones 1 and 2 volumes independent.

: Select tracks or albums.
 : Repeat one or all.

Drag slider to adjust volume. Globally adjust volume.







Close button

Swipe to change source.

Show or hide [ZONES] panel.

Show or hide [TONES] panel.

Display example: iPod

-  Tap: Goto previous title.
Hold down: Go back.
-  : Playback, pause.
-  Tap: Goto next number.
Hold down: Fast forward.
-  : Lower volume.
-  : Mute/unmute.
-  : Raise volume.

[TONES] panel

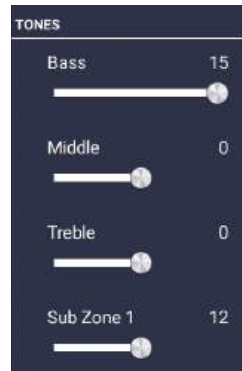

12.2 FUSION Operation Bar

The FUSION controls can be accessed two ways:

- Tap [Fusion] on the Slide-out menu.

Tap to show or hide the FUSION operation bar. →

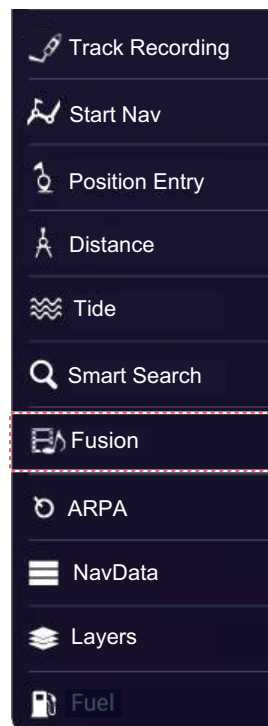

- Tap (long tap) the screen with two fingers.
Note: To use this method, [General]→[This Display]→[Two Finger Tap Function] (or [Two Finger Long Tap Function])→[Fusion Bar].

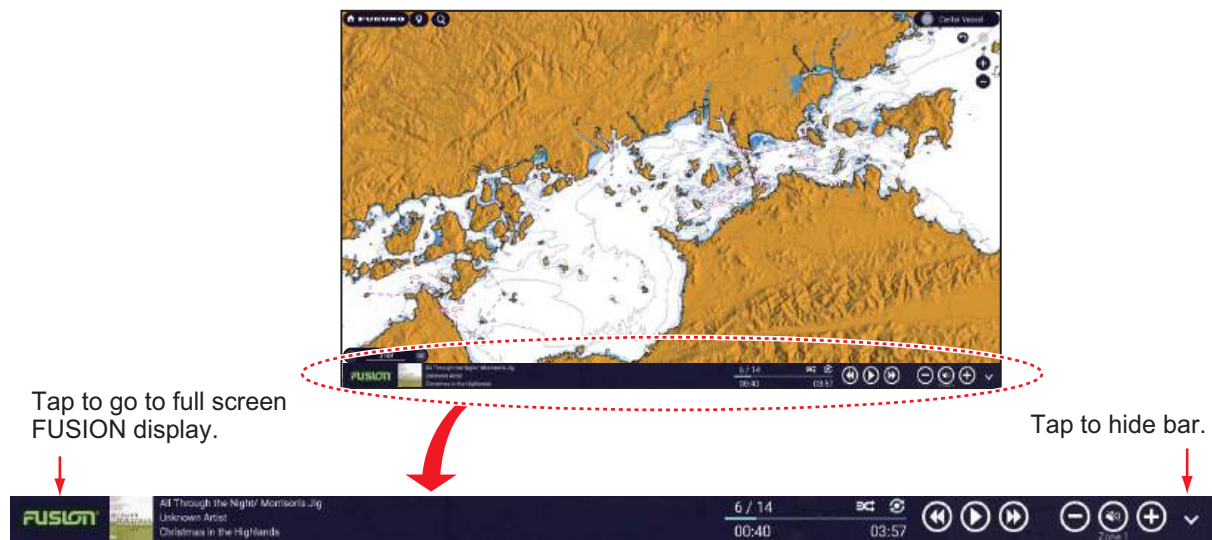

12.3 FUSION Settings

To access FUSION settings, Home page→[Initial Setup]→[Fusion]. Set the [Fusion] items referring to the descriptions shown below.

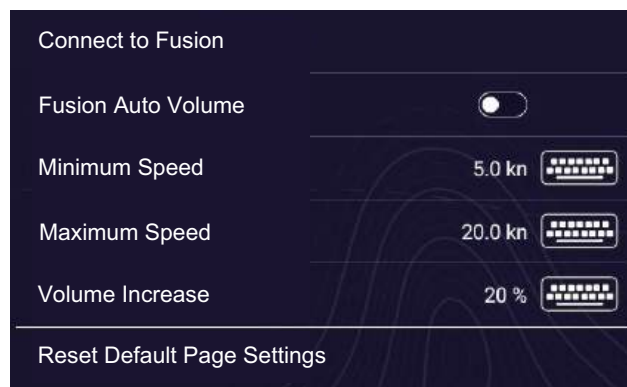

[Connect to Fusion]: Connects to your Fusion equipment.

[Fusion Auto Volume]: Turn on to allow this unit to control the Fusion volume.

[Minimum Speed]: Set the minimum speed that triggers the volume auto control.

[Maximum Speed]: Set the maximum speed that triggers the volume auto control.

[Volume Increase]: Set the amount of extra volume to output when the speed is that set at [Maximum Speed].

[Reset Default Page Settings]: Reset the [Fusion] menu settings to default.

This page is intentionally left blank.

13. INSTRUMENT DISPLAYS

With the necessary sensors, the instrument display shows multiple instrument data (voyage and environmental information) on a single screen. Data can be displayed in graphic, numeric, highway and NAVpilot formats. For information on what data can be shown on split instrument screens, see section 1.7. Additionally, this chapter describes the fuel management and CZone functions.

13.1 How to Show the Instrument Display

Prepare an instrument display on the Home page, referring to subsection 1.7.1. Tap the instrument display icon to show the instrument display.

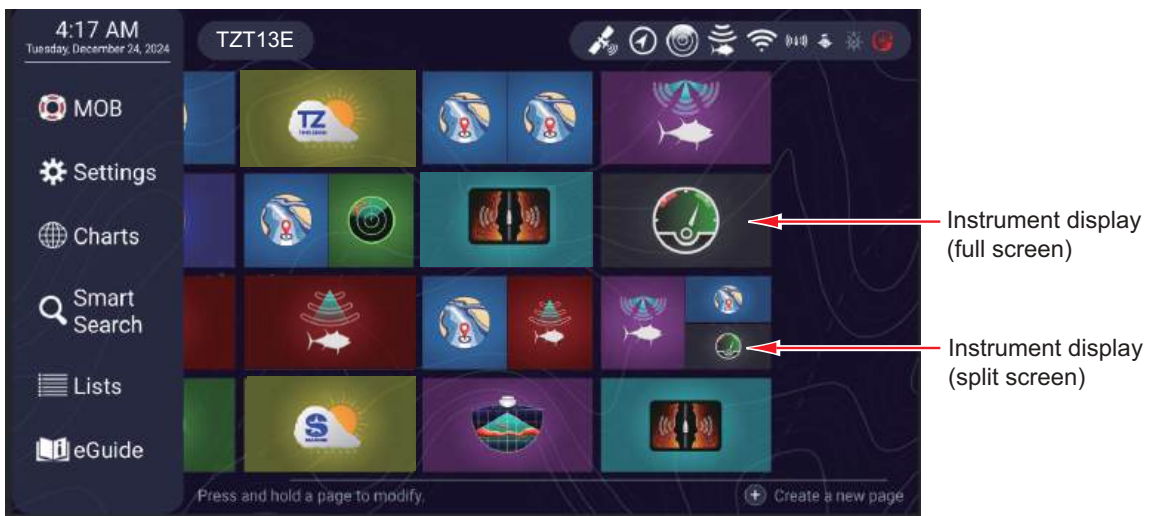

Note 1: When the SUZUKI engine function is enabled, the instrument display icon changes to SUZUKI engine icon as shown on the right-hand figure.



Note 2: The [FURUNO] icon (top left corner) is not shown on the instrument display. To display the icon, tap the display.

13.2 Instrument Displays

This section provides examples of the instrument displays, in their default arrangements.

13.2.1 Full-screen instrument displays

There are four default full-screen displays, [Sailing], [Cruising], [Outboard]*, and [Highway].

*: Displays the number of engines (default setting: 2) set with [Engine Count], in the [Initial Setup] menu. See section 16.3.

Sailing instrument display



Cruising instrument display

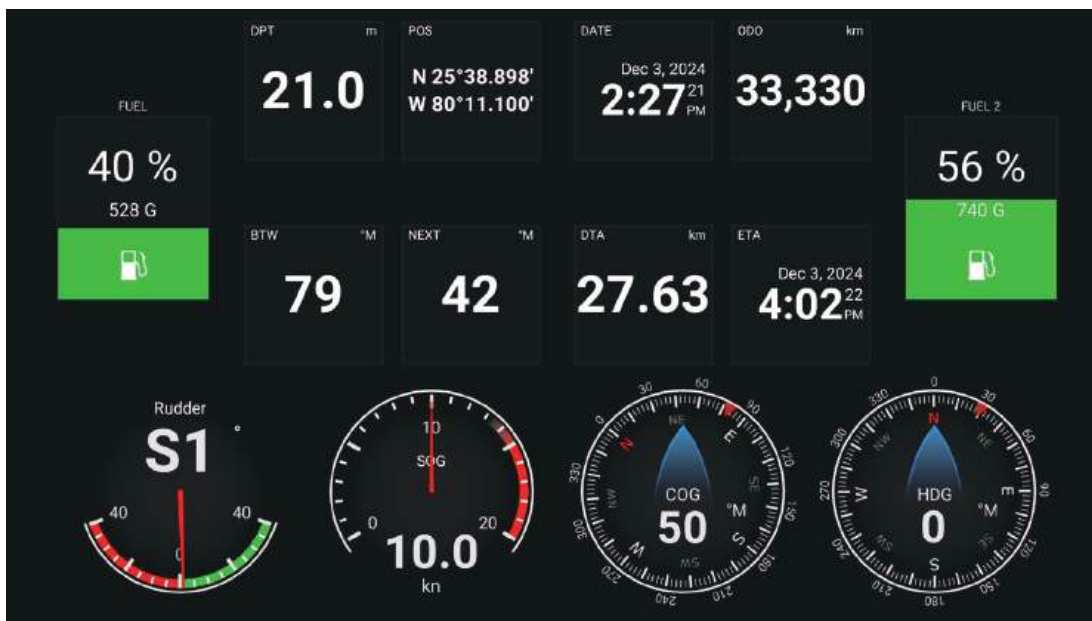

Outboard engine (ex. twin engines) instrument display

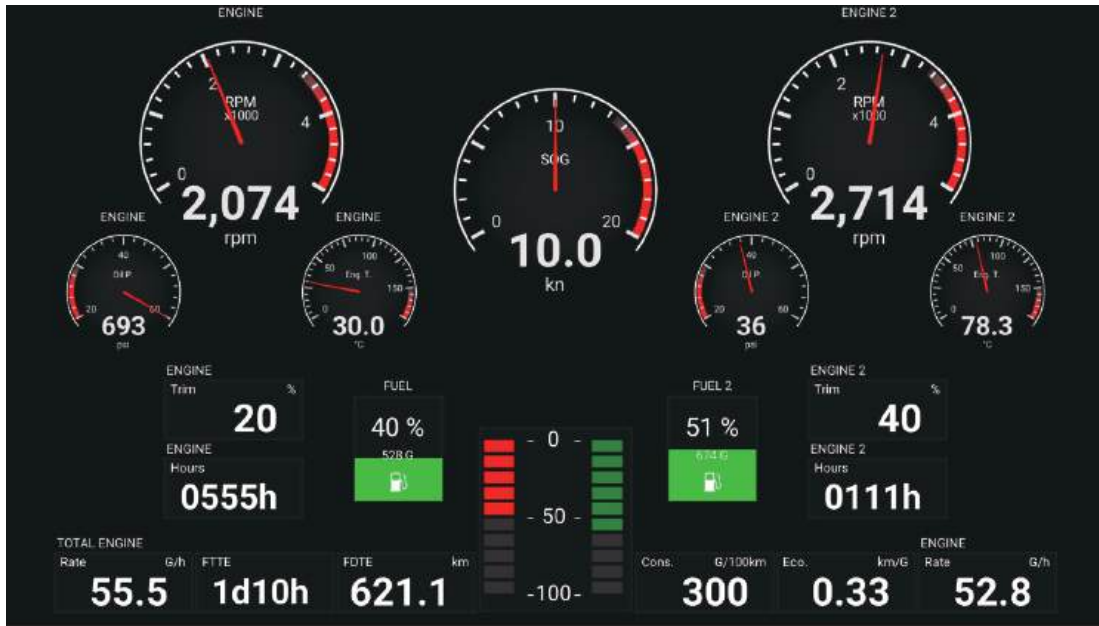

13

The screen showing the number of engines (factory default: 2) set with [Engine Count] (see section 16.3) appears.

Highway instrument display



13.2.2 Split screen instrument display

The default displays in the split screen are [Navigation], [Graphs], [Environment], [Wind], [Numeric], [Highway], [NAVPilot], [Twin Engines]*, and [Tank]. The availability of a display depends on your system configuration.

*: Displays the number of engines (default setting: 2) set with [Engine Count]. See section 16.3.

Navigation instrument display



Graphs instrument display

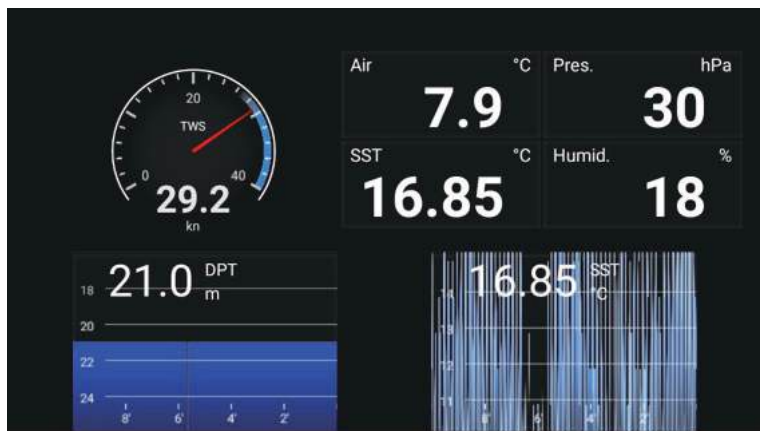

Environment instrument display



Wind instrument display



Numeric instrument display

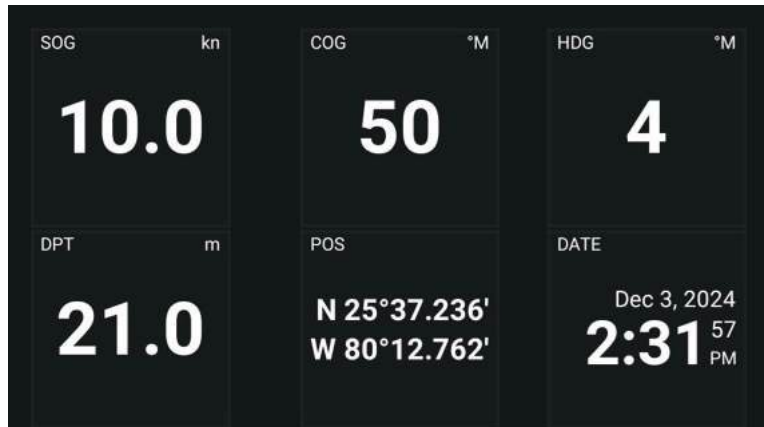

Highway instrument display

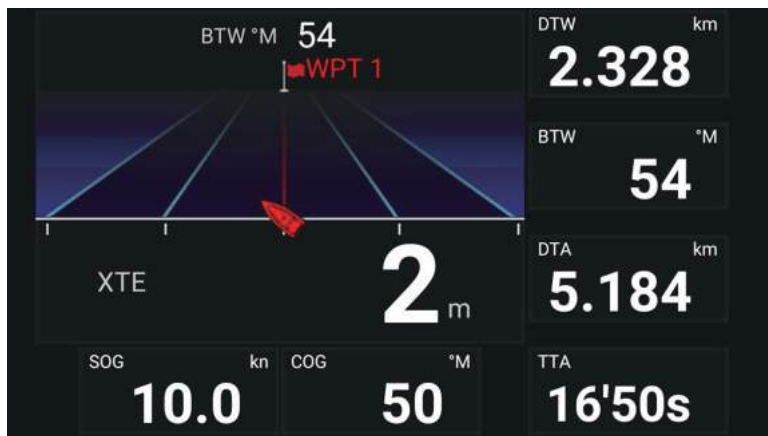

13

NAVpilot instrument display

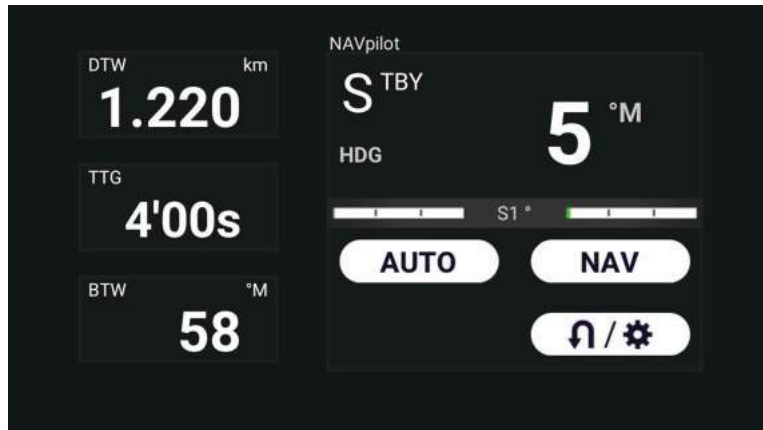

Twin engine instrument display



Single engine, twin engines, and triple engines can be displayed on the split screen.

Tank instrument display

The tank display shows the fuel level in both analog and digital formats. The analog display indicates an increase or decrease in fuel level and changes color according to the percentage of fuel remaining.

Green: 10% - 100% Red: 0% - 10%



13.2.3 How to switch between instrument displays

Note: The data that can be displayed depends on the your system configuration.

You can show the full-screen instrument display by these two methods.

- Swipe the screen leftward or rightward. The name of the currently shown display appears at the center of the screen.
- Long-tap the screen to show the instrument screen selection window, shown below.

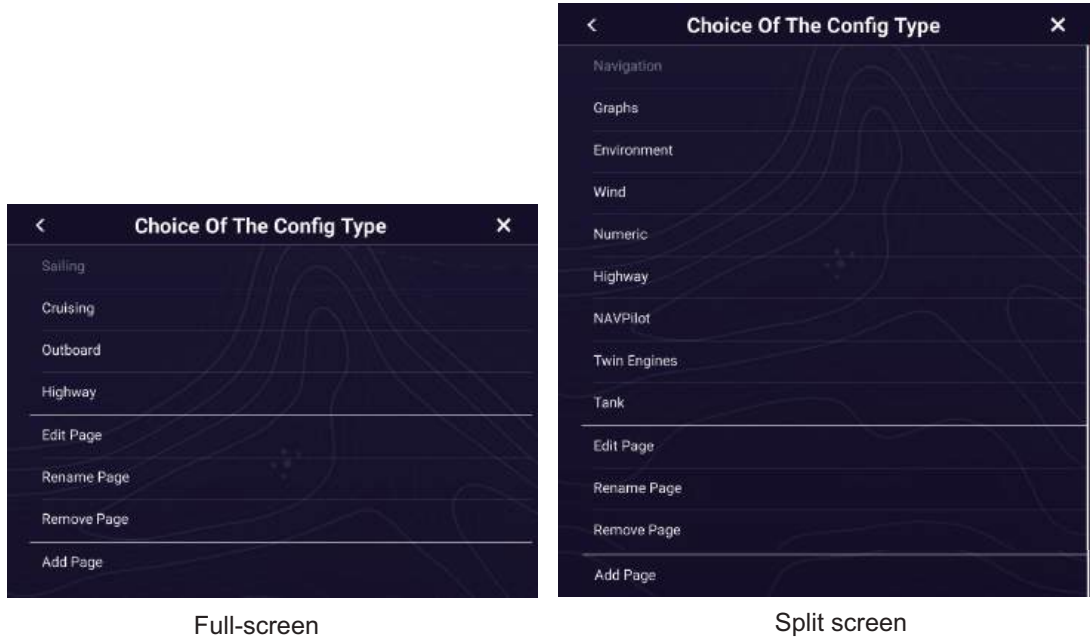

13.2.4 How to pin instrument screens

The pin function displays the pinned instrument display page. Tap the instrument display icon on the home page, then tap the icon at top-right corner of the instrument display to set the pinning.



Pinned



Unpinned

The pinned instrument display appears with an icon on the home page as shown below.

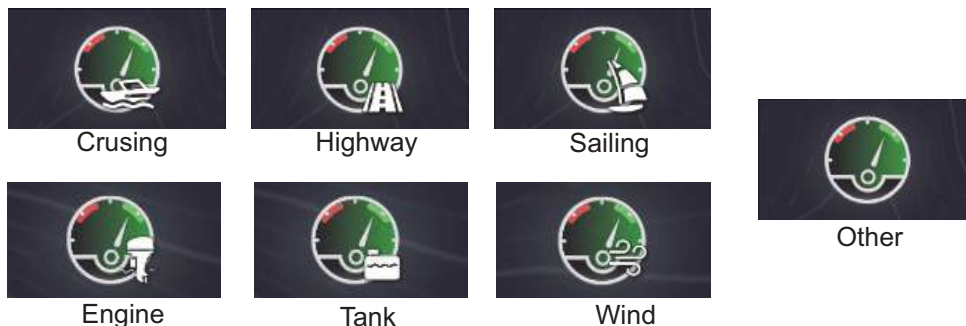

Note: The pinning function cannot be used on the same network.

13.3 How to Edit the Instrument Displays

The instrument displays are fully customizable. You can edit the displays as follows:

- Remove an indication from a display
- Add an indication to a display
- Rearrange the indications in a display
- Change the information displayed
- Rename a display
- Remove a display
- Add a custom display

Note: To restore the default instrument displays, Home page→[Settings]→[Initial Setup]→[Graphic Instruments Setup]→[Reset Instrument Pages]→Check confirmation message→[OK]. All screens (including SUZUKI engine, see section 13.7) are returned to their default arrangement and added displays are deleted.

13.3.1 How to prepare for editing

To start the editing process, long tap anywhere on an instrument display to show the Pop-up menu, then tap [Edit Page] on the menu. A white line circumscribes each indication in the display, as shown in the figure below. Edit the display referring to the procedures in the coming sections. To save your changes, tap anywhere on the instrument display to show the Pop-up menu, then tap [End Edit] on the menu.



13.3.2 How to rearrange the indications in an instrument display

In the edit mode (see subsection 13.3.1), drag the instrument displays to rearrange them to your liking.

13.3.3 How to edit, remove an indication in an instrument display

1. Prepare the display for editing as shown in section 13.3.1.
2. Tap the indication to process to show the [Edit Instrument] Pop-up menu.

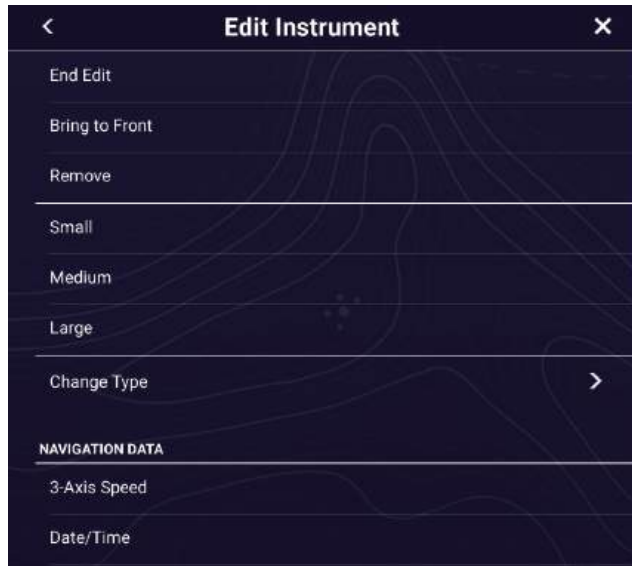

Scroll to see other options.

3. Do one of the following depending on your objective:
 - **Bring to front:** If two indications are occupying the same location, you can select one to bring to the front. Tap the indication to bring to the front, then tap [Bring to Front].
 - **Remove:** Tap [Remove].
 - **Change indication category:** Tap the item to change, then select desired item in [NAVIGATION DATA], [ROUTE INFORMATION], [WIND AND WEATHER], [ENGINE]. The available data is as shown in the table below. The data that can be displayed depends on the selected instrument display.

NAVIGATION DATA		
3-Axis Speed	Date/Time	Course over Ground
Speed over Ground	Boat Position	HDOP
Depth	Boat Heading	Course Through Water
Speed Through Water	Current Direction	Current Speed
Rudder	Rate of Turn	Total cumulative distance
Roll	Pitch	Power Supply Voltage
ROUTE INFORMATION		
Bearing to Waypoint	Next Course	Time to go (using VMC)
Distance to Waypoint	Cross Track Error	Estimated Time Arrival
Time to Arrival	Distance to Arrival	Heading to Steer
Velocity Made Good	Velocity Made Course	
WIND AND WEATHER		
Sea Surface Temperature	True Wind Direction (North)	True Wind Speed (Bow)
True Wind Speed	Apparent Wind Angle	Apparent Wind Speed
Atmospheric Pressure	Air Temperature	Humidity
Dew Point	Wind Chill Temperature	
ENGINE		
ENGINE*	ENGINE 2*	ENGINE 3*
ENGINE 4*	ENGINE 5*	ENGINE 6*

TOTAL ENGINE Fuel Rate	Fuel Distance to Empty	Fuel Time to Empty
Fuel Consumption	Fuel Economy Average	Fuel Consumption

*: For ENGINE to ENGINE 6, you can further select from the following data.

Fuel Rate	RPM	Boost Pressure
Oil Pressure	Oil Temperature	Temperature
Trim	Alternator Potential	Coolant Pressure
Fuel Pressure	Load	Hours
Transmission Oil Pressure	Transmission Oil Temperature	

- **Change the indication size:** Tap [Change Type] and select the desired size as shown below.
- **Change the format:** Tap [Change Type] to show the Pop-up menu shown below. Choose the format and size.

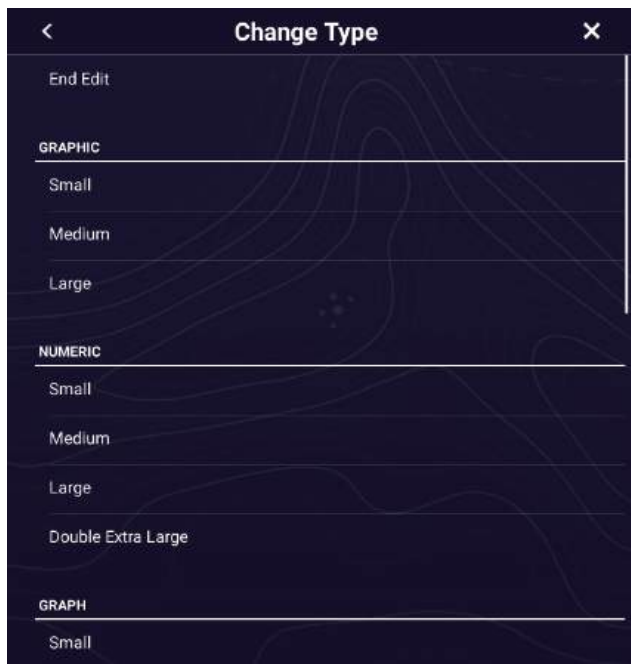

Scroll to see other options.

The format choices are [GRAPHIC], [NUMERIC], [GRAPH]*1, [TANK]*2, [HIGHWAY], [NAVPILOT]*3, and [TRIM TABS]*4. The available indications sizes are [Small], [Medium], [Large], [Double Extra Large]*5 (available with [NUMERIC] indications only).

*1: Graph cannot be displayed for engine or tank data.

*2: Displayed with connection of a tank sensor, or when [MANUAL FUEL TANK] is turned on. See subsection 13.5.1

*3: Requires connection of FURUNO NAVpilot.

*4: Boat must be fitted with trim tabs.

*5: [Numeric] category only

- **Change graph plotting time (horizontal axis):** Tap [Plot Period]* to change the time over which the graph's data is plotted.
* Depending on the display time, the number of data points displayed on the graph may be reduced, and the graph may be coarse.
- **Change graph plotting range (vertical axis):** Tap [Plot Range Value] to change the range for the data display in the graph. Tap [✓] to finish and close the keyboard.

13.3.4 How to add an indication to an instrument display

1. Prepare the display for editing as shown in "How to prepare for editing" on page 13-8.
2. Tap an unoccupied position on the instrument display to show the [Add Instrument] Pop-up menu.

Note 1: If there is no space available, remove an unnecessary indication following the procedure in "How to prepare for editing" on page 13-8.

Note 2: You can show a maximum of 24 displays in the full screen instrument display; 10 displays in a split-screen display.

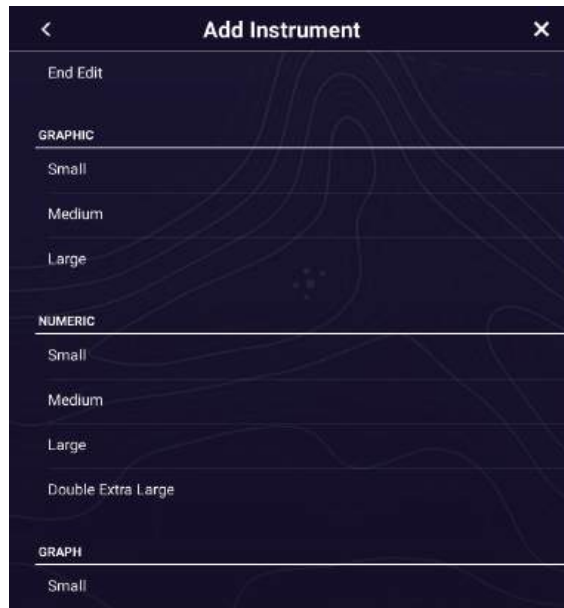

Scroll to see other options.

3. Tap a size in the applicable section.

SEPARATOR

Lines can be drawn, for example, on the top and bottom of the instrument display to divide the instrument display.

- 1) Tap the area on the instrument display where you want to draw a line.
- 2) Select the length of the line under [SEPARATOR].
- 3) Select [Red] or [White] for the line color.
- 4) To change the line position, tap the line to show the white frame that surrounds the line, then move the line to the desired position.

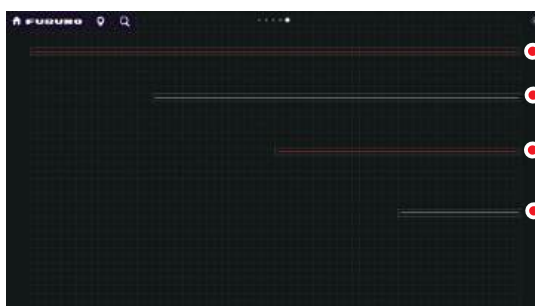
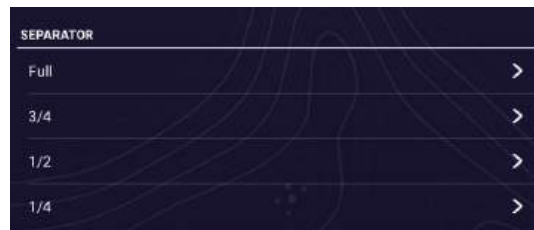

● [Full], [Red] line color

● [3/4], [White] line color

● [1/2], [Red] line color

● [1/4], [White] line color

4. Tap the added instrument display to change its data. See subsection 13.3.3.

13.3.5 How to rename an instrument display

1. Show the instrument display that you want to rename.
2. Long tap the display to show the [Choice of Config Type] Pop-up menu.
3. Tap [Rename Page] to show the software keyboard.
4. Enter new name (maximum of 20 alphanumeric characters), then tap [✓].

13.3.6 How to remove an instrument display

Tap the instrument display to show the Pop-up menu, then tap [Remove Page] on the menu.

1. Show the instrument display that you want to remove.
2. Long tap the display to show the [Choice of Config Type] Pop-up menu.
3. Tap [Remove Page]. You are asked if you are sure to remove the page.
4. Tap [OK] to remove the page.

13.3.7 How to add an instrument display

Full screen, three-, four-way split screens are preset in this equipment. If the displays do not meet your requirements, you may add custom displays as necessary. You can have 10 full screen displays, and 10 split screens (3-way, 4-way).

1. Long tap the instrument display to show the [Choice of Config Type] Pop-up menu.
2. Tap [Add Page] to show the software keyboard.
Note: If you have reached the capacity for the screen configuration selected, [Add Page] is grayed out. Remove an unnecessary page referring to "How to edit, remove an indication in an instrument display" on page 13-9.
3. Enter a name for the page then tap [✓]. A blank page appears.
4. Tap the blank page to show the [Add Instrument] Pop-up menu.
5. Tap a size in the applicable section.
6. Repeat steps 4 and 5 to add other items.
7. After you have added all items required, tap the screen to show the [Add Instrument] Pop-up menu, then tap [End Edit] to finish.
The page name appears in the [Choice of The Config Type] Pop-up menu.
8. if you need to rearrange the data, see section 13.3.2 and section 13.3.3.

13.3.8 SC-33/SCX-20 3-axis speed display

With connection of a SC-33/SCX-20 Satellite Compass™ in the network, a dedicated 3-axis speed display data box can be shown in the Data window.

This function requires input of the PGN data sentence 130578 (Vessel Speed Components).

Referring to section 13.3.3 and section 13.3.4, tap [3-Axis Speed].

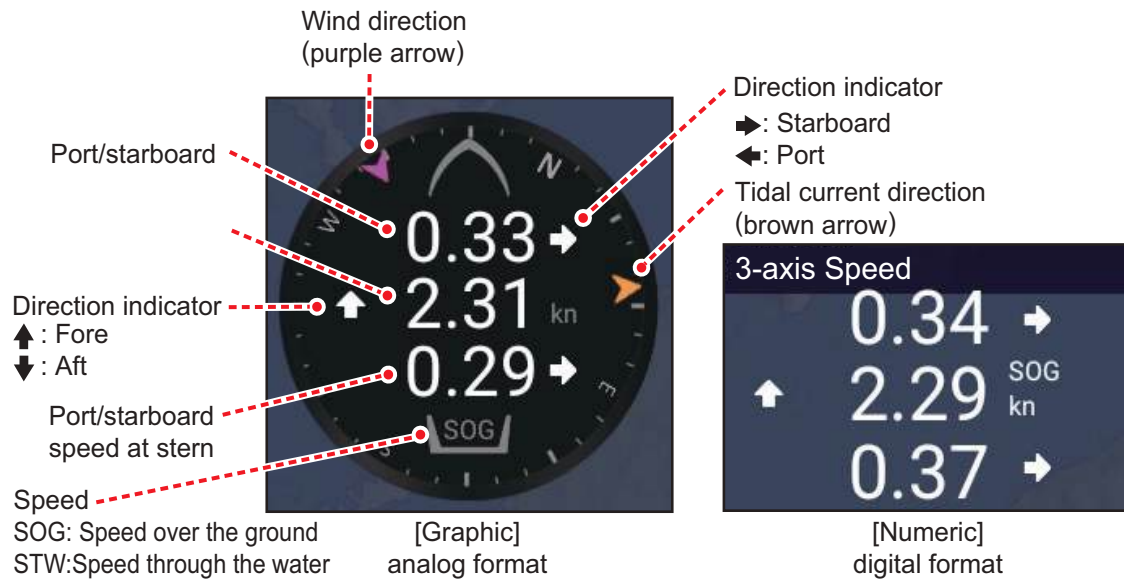

*: CCRP (Consistent Common Reference Point) is determined at installation, and is either the bow, transducer location, or center of vessel.

13.4 Instrument Theme, Instrument Background

The instrument display has two styles; [Modern] and [Legacy]. To change the style, select Home page→[Settings]→[Initial Setup]→[Instruments Setup]→[Graphic Instruments Setup]→[Instruments Theme], then tap [Modern] or [Legacy].



[Modern] display example



[Legacy] display example

13.5 Fuel Management System

This equipment can calculate the remaining fuel from the total fuel and the fuel consumption rate. This function requires the NMEA 2000 PGN127489 (Engine Fuel Rate).

Note: The remaining fuel calculation is for reference purposes. Do not use the results for navigation planning or emergency purposes. During an entire voyage, select one TZMAP9/13 or TZT9E/13E unit for the calculation at start-up. The calculation of remaining fuel is not done when the unit is powered off.

13.5.1 How to manually enter fuel tank capacity

1. Home page→[Settings]→[Initial Setup]→[Manual Fuel Management].
2. At [Total Fuel Capacity], enter your vessel's total fuel capacity.
3. Turn on [Manual Fuel Management].
4. Read the disclaimer, then tap [OK] to finish and close the menu.

13.5.2 How to check remaining fuel amount

You can check remaining fuel and update fuel amount from the Slide-out menu.

Manual Fuel Mana...		×
Total Fuel Remaining (volume)	0.0L	
Total Fuel Remaining (%)	0 %	
UPDATE FUEL AMOUNT		
Fill up all tanks		
Add Fuel		
Remove Fuel		

How to fill up all tanks

1. Tap [Fill up all tanks] on the [Manual Fuel Management] Pop-up menu. You are asked to confirm that you want to fill up all tanks.
2. Tap the [OK] button.
3. Tap [×] on the Pop-up menu to finish.

How to add fuel

1. Tap [Add Fuel] on the [Manual Fuel Management] Pop-up menu. You are asked to confirm that you want to fill up all tanks.
2. Enter the amount of fuel to add, then tap [✓].
If you mistakenly increase the fuel, you can reduce the amount by clicking [Remove Fuel]. to display the software keyboard. Set the amount of fuel to remove, then tap [✓].
3. Tap [×] on the Pop-up menu to finish.

13.6 CZone

The TZMAP9/13 or TZT9E/13E can control Power Products' CZone equipment connected in the NavNet network. CZone is a shipboard power management system.

This equipment controls [CZone Control], [CZone Modes] and [CZone Monitoring].

- **CZone Control:** Controls the power of individual CZone equipment.
- **CZone Modes:** Controls the power of multiple CZone equipment.
- **CZone Monitoring:** Shows temperature, pressure, fuel tank and battery state of CZone equipment.

The table below shows the points of control of each CZone system.

System name	Instrument display	Data window	Slide-out menu
CZone Control	Yes	No	Yes
CZone Modes	Yes	Yes	Yes
CZone Monitoring	Yes (display only)	Yes (display only)	No

13.6.1 How to use CZone

After confirming the following two items, set up your NavNet system to use CZone.C

- This equipment is connected to the CZone system and NavNet network by NMEA 2000 interface.
- CZone equipment have been properly set.

How to add/edit CZone pages

Add or edit CZone pages in the following instances:

- First use of CZone
 - Setting changed at the CZone system
1. Home page→[Settings]→[Initial Setup]→[Graphic Instruments Setup]→[Add Default CZone Pages]. You are asked if it is OK to add or edit CZone pages.
 2. Tap the [OK] button.
 3. Tap [x] on the title bar to finish and close the menu.

About the DIP switches

For the service technician. Do not change the settings.

13.6.2 CZone control

Display and operations from the instrument display

1. Open the Home page, then tap the instrument display icon.
If there is no instrument display icon, see section 1.7.1 for how to add the icon.
2. Long tap the display screen, to show the [Choice of the Config Type] Pop-up menu.

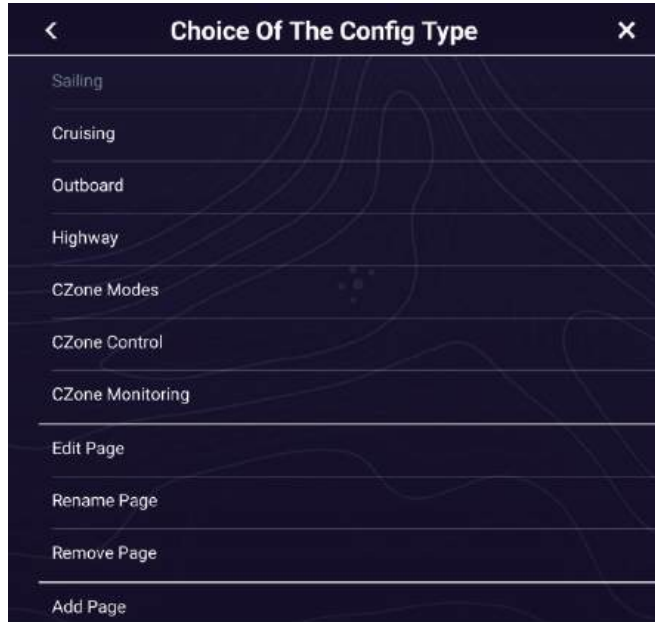

3. Tap [CZone Control] to show the [CZone Control] screen. Use [ON], [OFF], [←], [↑], [↓], [→] to control CZone equipment.

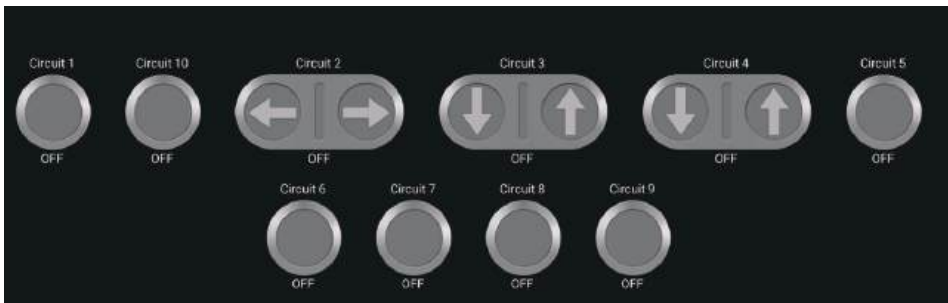

CZone Control screen (example)

You can customize the [CZone Control], [CZone Modes] and [CZone Monitoring] screens. See section 13.3.



Customized screen (example)

Display and operations from the Slide-out menu

1. Open the Slide-out menu.
2. Tap [CZone Control] to show the following menu.

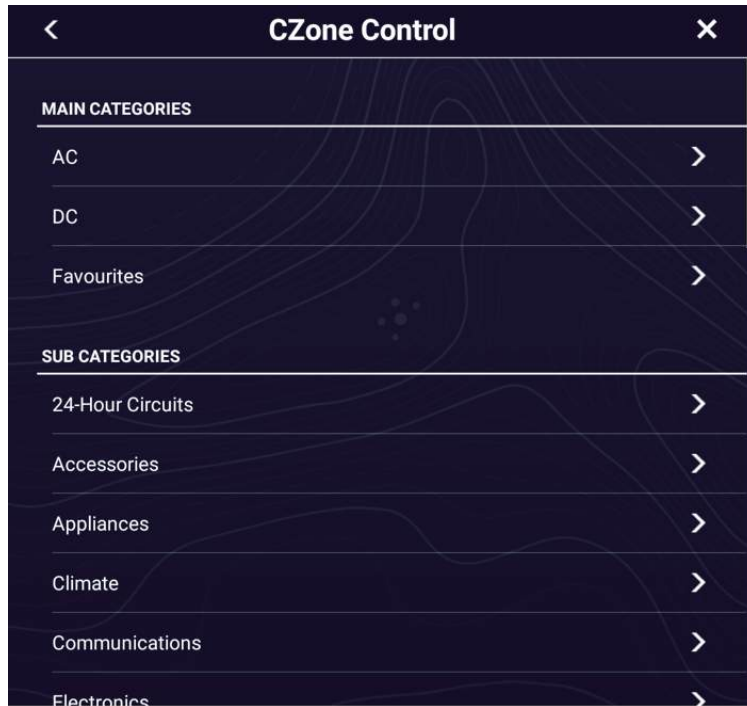

3. Swipe up or down or tap [>] to select CZone equipment.
4. Use [ON], [OFF], [←], [↑], [↓], [→] to control CZone equipment.
5. Tap [x] on the title bar to finish and close the menu.

13.6.3 CZone modes**Display and operations from the instrument display**

1. Open the Home page, then tap the instrument display icon. If there is no instrument display icon, see section 1.7.1 for how to add the icon.
2. Tap the screen to show the Pop-up menu.

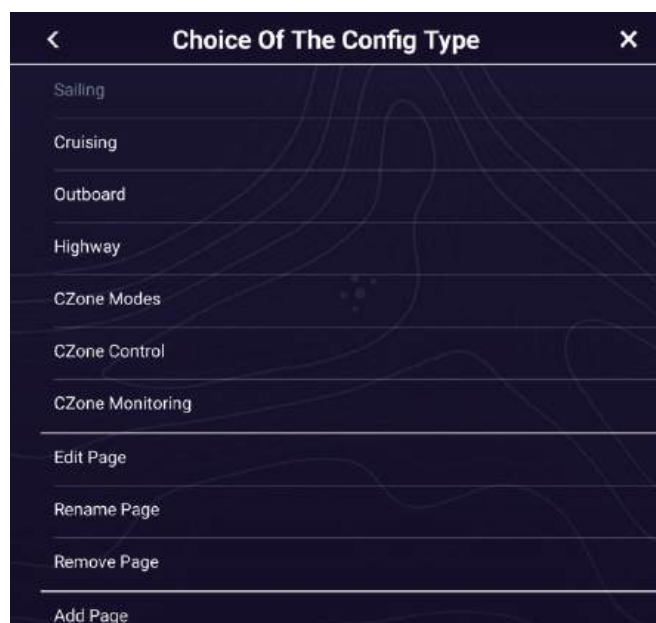

13. INSTRUMENT DISPLAYS

3. Tap [CZone Modes] to show the following screen.
Tap the [ON], [OFF] button to operate a CZone equipment.



You can customize the [CZone Control], [CZone Modes] and [CZone Monitoring] screens. See section 13.3.



Customized screen (example)

Display and operations from the Data window

1. Show the Data window.
2. Tap the [EDIT] button at the bottom of the Data window to show the [Edit NavData] display.
3. Tap a vacant area in the Data window to show the [Add Nav Data] menu,

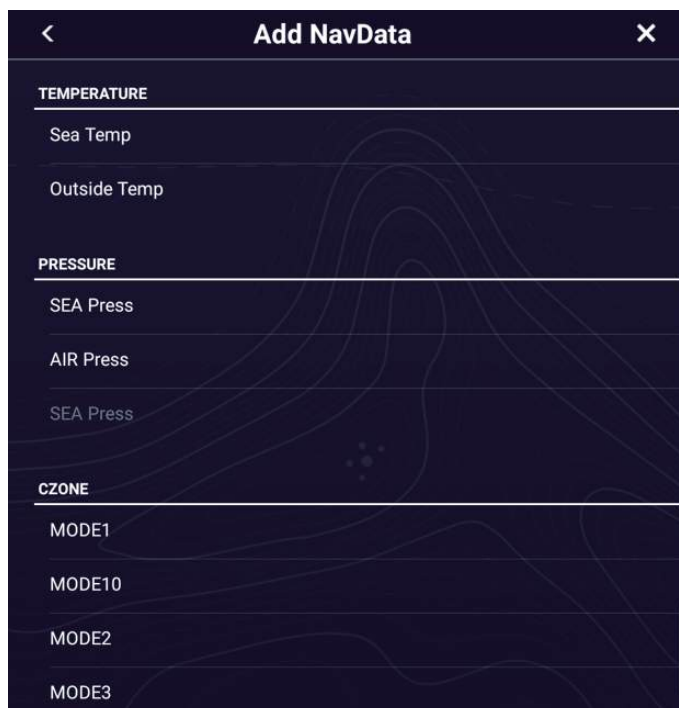

- Tap the display mode that you want to add. The selected item appears at the bottom of the Data window.

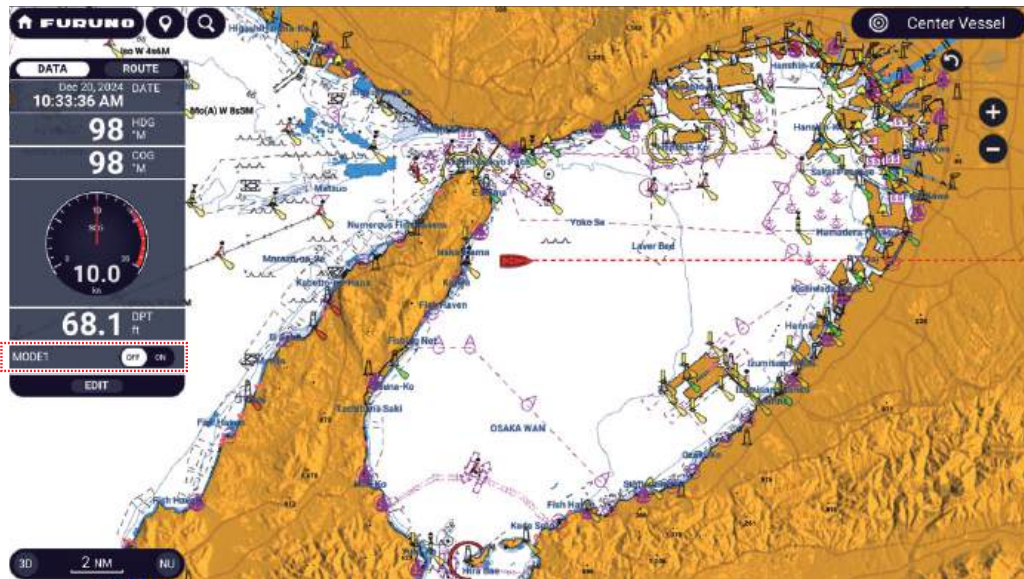

- Tap the added item to control corresponding CZone device.

Display and operations from the Slide-out menu

- Open the Slide-out menu.
- Tap [CZone Modes] to show the following menu. A list of CZone modes appear.
- Tap the mode to use.

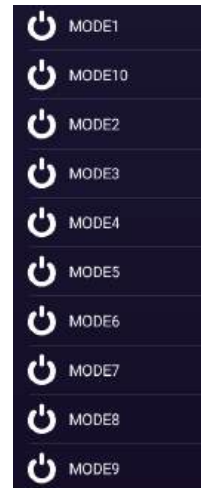

13.6.4 CZone monitoring

Display on the instruments display

- Open the Home page, then tap the instrument display icon. If there is no instrument display icon, see section 1.7.1 for how to add the icon.
- Tap the screen to show the Pop-up menu.

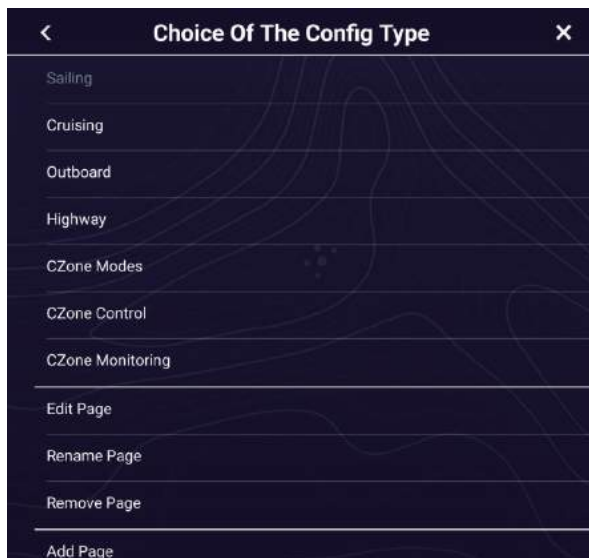

13. INSTRUMENT DISPLAYS

3. Tap [CZone Monitoring] to show the following screen.

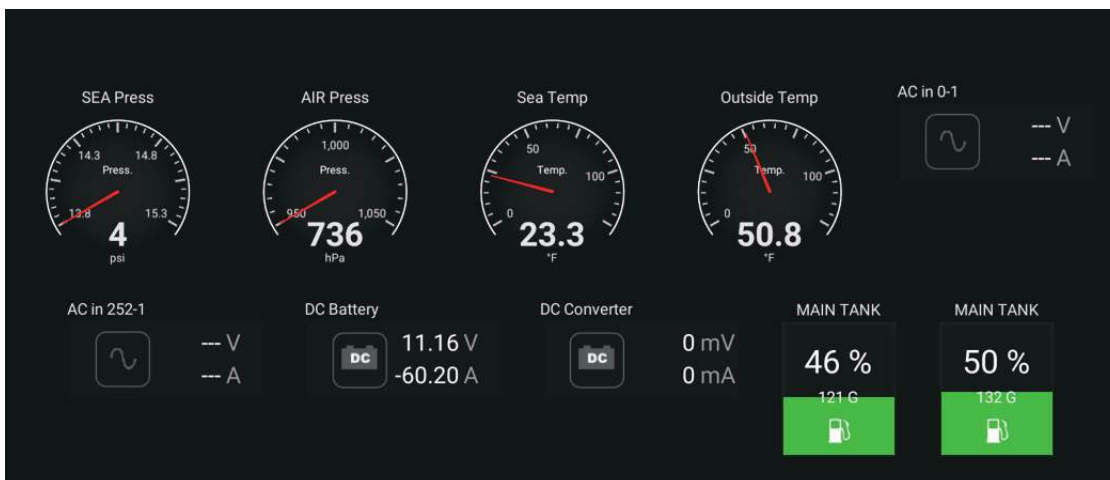

You can customize the [CZone Control], [CZone Modes] and [CZone Monitoring] screens. See section 13.3.

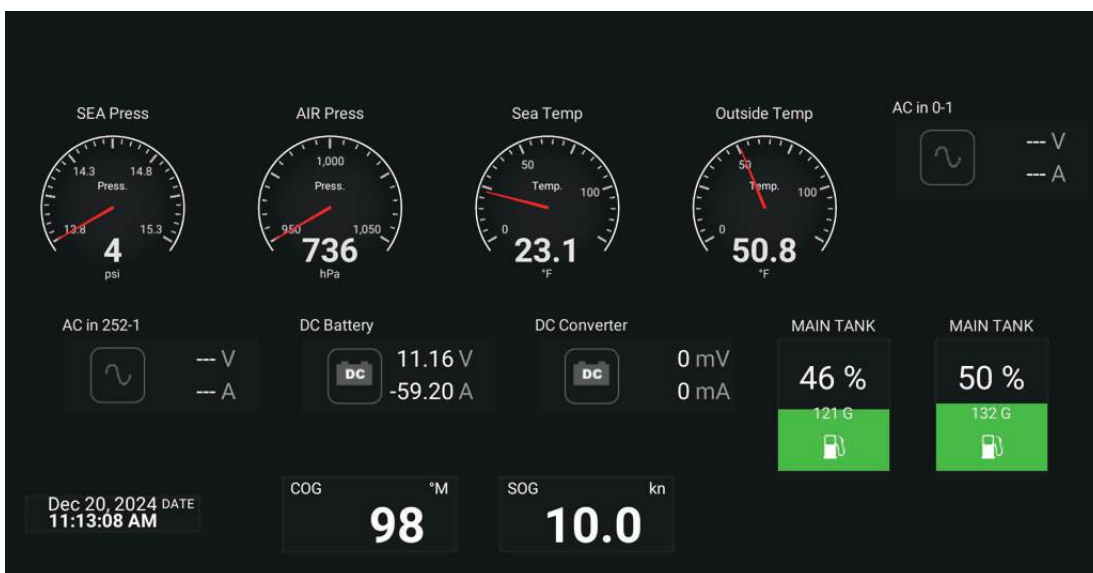

Customized screen (example)

4. Tap [x] on the title bar to finish and close the menu.

Display and operations from the Data window

1. Show the Data window.
2. Tap the [EDIT] button at the bottom of the Data window to show the [Edit NavData] display.
3. At the bottom right corner tap [+ Add Nav Data] to show the [Add Nav Data] window.
4. Tap the display mode to add. The selected item appears at the bottom of the Data window. In the example below, water temperature data is shown. To add or delete data, see section 1.9.2 (add data) or section 1.9.4 (delete data).

13.7 SUZUKI Engine Function

The SUZUKI engine function is available when connecting to a SUZUKI engine(s). The instrument displays are specifically displayed for the engine use. The SUZUKI engine functions can be set from the menu.

Note: To enable the SUZUKI engine function, settings need to be changed by a service technician (see the Installation Manual for details).

SUZUKI engine settings can be adjusted in the [Engine Setup] menu. There are two methods to access to the [Engine Setup] menu.

- Home page→[Settings]→[Suzuki Engine Setup].
- Open the Slide-out menu→[Suzuki Engine Setup].

Hereafter, In this manual, this operation is described as "Open the [Suzuki Engine Setup] menu."

13

13.7.1 SUZUKI engine instrument display examples

Full screen

Four types of SUZUKI engine displays are registered in the default arrangement (Engines*, Full 1, Full 2, and Historical Graphs).

*: The number of engines set at the time of installation is displayed on the screen (refer to the Installation Manual).The display examples are as follows.

Engines display (for 1 engine)



13. INSTRUMENT DISPLAYS

Full 1 display



Full 2 display



Historical Graphs display



3-way split screen

Nine types of SUZUKI engine displays are registered in the default arrangement (Engines*, Navigation, Historical Graphs, Environment Numerical, Wind, Numeric, Highway, NAVPilot, Tank).

*: The number of engines set at the time of installation is displayed on the screen (refer to the Installation Manual). The display examples are as follows.

Engines display (for 1 engine)



Navigation display



Historical Graphs display



13. INSTRUMENT DISPLAYS

Environment Numerical display



Wind display



Numeric display



Highway display

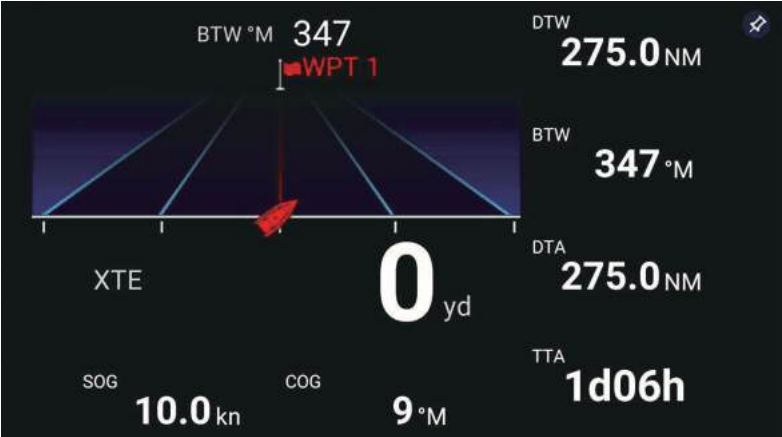

NAVpilot display

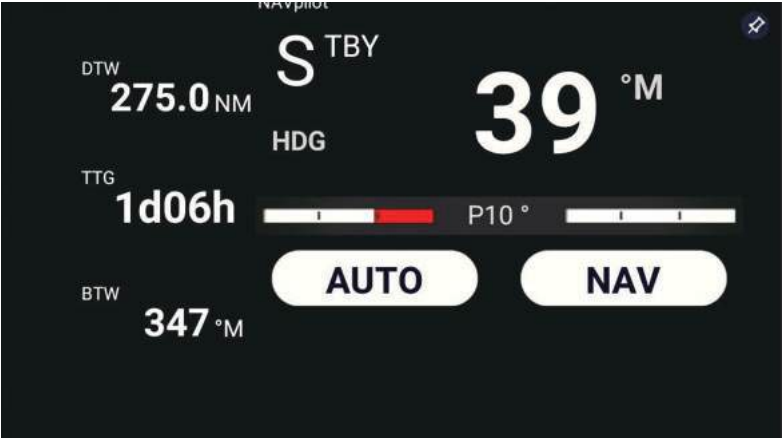

Tank display

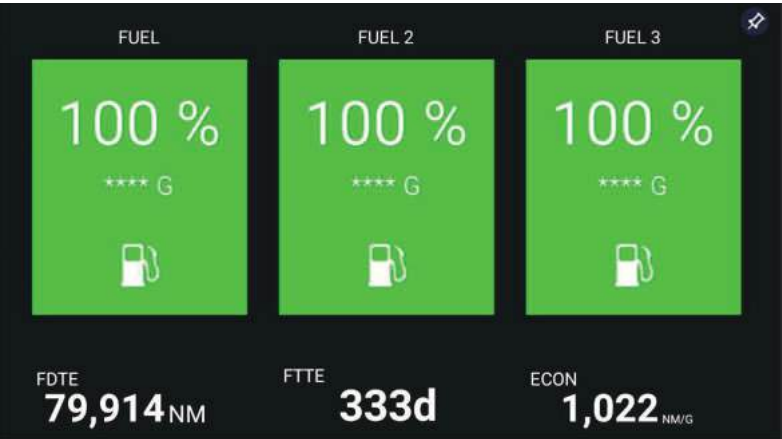

13

13.7.2 Troll mode

The troll mode is designed to keep the vessel at a constant speed and is ideal for troll fishing. For more information, refer to the SUZUKI engine Owner's Manual.

Note: Make sure to set all engines to neutral gear (idling) mode before activating the troll mode.

How to activate the troll mode

1. Open the Slide-out menu.

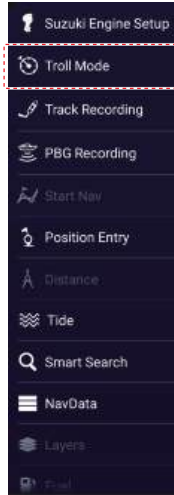

2. Tap [Troll Mode].

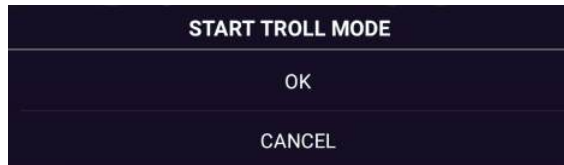

3. Tap [OK]. An icon for setting the trolling speed appears at the bottom left corner of the screen.



4. Use the [+]/[-] icons to adjust the trolling speed.
 - [+]: The engine speed increases by 50 r/min.
 - [-]: The engine speed decreases by 50 r/min.

How to cancel the troll mode

The troll mode can be canceled by shifting all remote control levers to the neutral position, or by increasing the engine speed to 3000 r/min or more.

13.7.3 Auto trim

Turn on auto trim to automatically change the trim angle. For more information about auto trim, refer to the SUZUKI engine Owner's Manual.

1. Set the trim position to the lower limit before adjusting the settings.
2. Open the [Suzuki Engine Setup] menu.
3. Set [Auto Trim] to on.

"A" appears on the screen as shown below. If the trim angle is not displayed on the screen, "A" is not displayed. When auto trim is interrupted, "A" flashes.

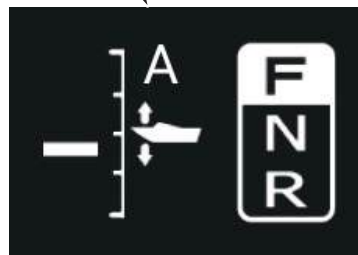

13.7.4 Keyless

Pass code can be changed to keyless. Place the registered keyless fob within 0.3 m (12 in) from the keyless control unit.

1. Open the [Suzuki Engine Setup] menu.
2. Tap [Keyless]. The message "Please prepare a registered Keyless FOB." appears.
3. To change the pass code, tap [OK]. To cancel, tap [Cancel]. The current pass code is displayed in [Pass Code]

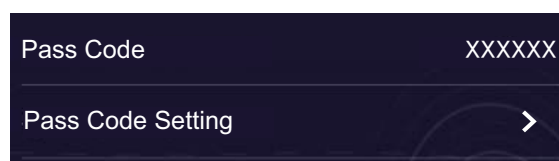

If there is no keyless FOB nearby, the message "Keyless FOB authentication error." appears.

Note: The keyless screen will change to the menu screen in 1 minute if no operation is performed.

13. INSTRUMENT DISPLAYS

4. Tap [Pass Code].

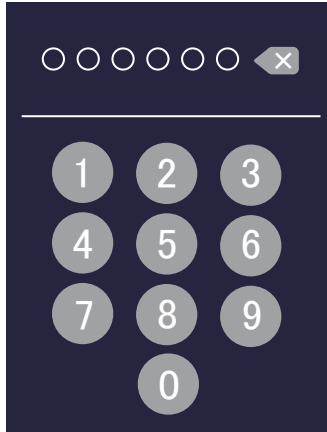

5. Enter the new six-digit password. The message "Pass code registration succeeded." appears.
6. Tap [OK].

13.7.5 Quick Response (QR) code

You can record and readout the engine information data with the SUZUKI Diagnostic System Mobile application. The engine information is converted into a Quick Response code to record data.

How to create quick response code

1. Open the [Suzuki Engine Setup] menu.
2. Tap [Create New QR Code].

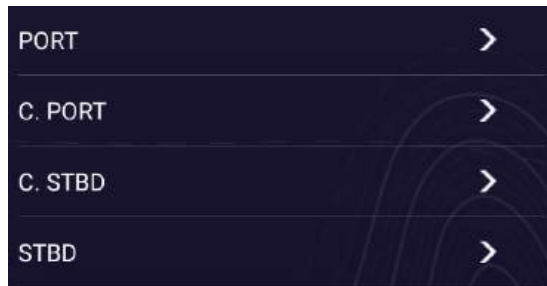

- Select an engine to create the Quick Response code. The code is created as shown below.

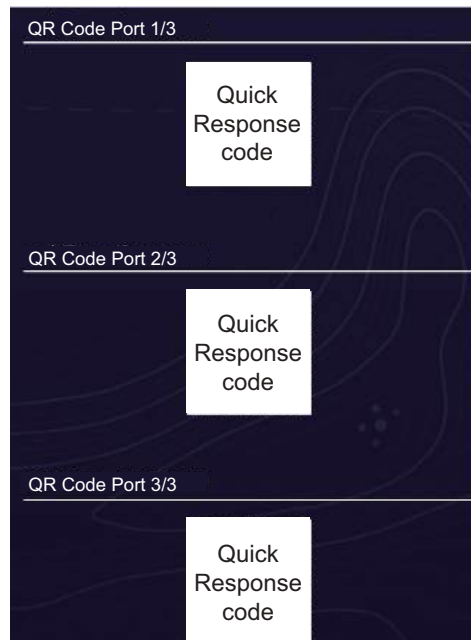

- Activate the SUZUKI Diagnostic System Mobile (S.D.S.M) application, and scan the Quick Response codes.

Note: If the Quick Response code cannot be scanned, adjust the brightness of the Multi-function display, or make sure the Multi-function display is not under direct sunlight.

How to view Quick Response code logs

- Open the [Suzuki Engine Setup] menu.
- Tap [View QR Code Logs].

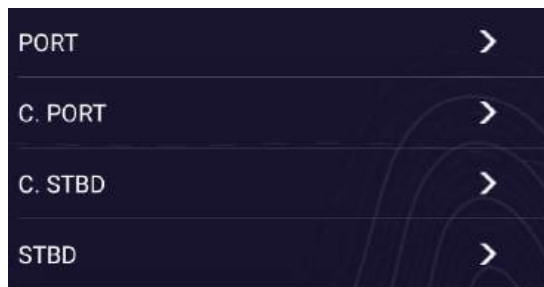

13. INSTRUMENT DISPLAYS

3. Select the engine to check the log.

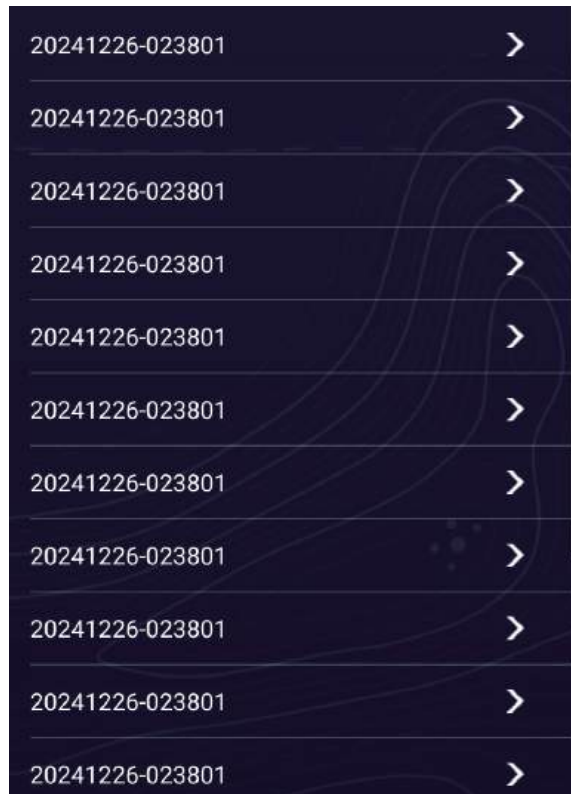

4. Select a file. The file names in the list appear in date/time order, with the latest file at the top of the list. Each Quick Response code file is named in the following format: year_month_day-hours_minutes_seconds.

13.7.6 Reset data

Do the following to reset the settings of the connected SUZUKI gateway device.

1. Open the [Suzuki Engine Setup] menu.
2. Tap [Reset Data...]. The message "ARE YOU SURE YOU WANT TO RESET DATA OF SUZUKI ENGINE?" appears.
3. Tap [OK].

13.7.7 Device list

Do the following to check the connected SUZUKI engine gateway or other devices.

1. Open the [Suzuki Engine Setup] menu.
2. Tap [Device List]. All names of connected devices are displayed.

13.7.8 SUZUKI engine alarms

When an alarm is activated regarding the SUZUKI engine, an alarm icon and message appear and flash on the Status bar at the top of the screen (for warnings, the background color is red and the text is yellow. For cautions, the background color is yellow and the text is black). Tap the status bar to stop the flashing and alarm sound. The alarm message does not disappear until the cause is resolved.



How to display activated alarms



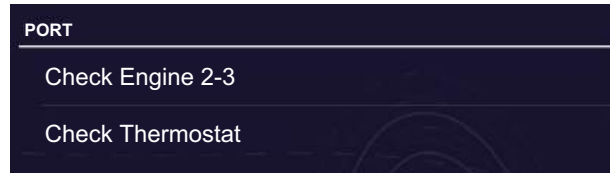





1. Open the [Suzuki Engine Setup] menu.
2. Tap [Diagnosis]. All activated alarms are displayed.



Alarm list

Message	Icon	Status	Description/Remedy
"LOW BATTERY VOLTAGE"		Warning	The battery voltage is low, which could impair your motor's performance. Take the appropriate measure referring to the Owner's Manual.
"Check engine *_*" *: A number indicating the fault location is displayed in *_*. The number is displayed in the 1st station only.		Caution	Engine error at named engine. Take the appropriate measure referring to the Owner's Manual.
"LOW OIL PRESSURE"		Warning	The oil pressure is below the proper level. Take the appropriate measure referring to the Owner's Manual.
"OVER HEAT"		Warning	Temperature of cylinder wall is too high because of insufficient cooling. Take the appropriate measure referring to the Owner's Manual.
"WATER IN FUEL"		Warning	The integral fuel filter/water separator detector has found water in the fuel. Drain the water referring to the Owner's Manual.
"Check Thermostat"		Caution	The engine temperature has not increased to an acceptable temperature. Take the appropriate measure referring to the Owner's Manual.

13. INSTRUMENT DISPLAYS

Message	Icon	Status	Description/Remedy
"REV LIMIT"	-	Caution	The engine speed exceeds maximum recommended speed for more than 10 seconds. Take the appropriate measure referring to the Owner's Manual.
"OVER REV"	-	Caution	Engine revolution is too high. If the condition continues, the revolution is reduced to approximately 3000 r/min and a buzzer sounds. Take the appropriate measure referring to the Owner's Manual.
"CHANGE OIL"	-	Caution	Time to change the oil, based on the maintenance schedule.
"HIGH OIL TEMP"		Warning	The oil temperature is too high (due to insufficient cooling), or the quality of the engine oil has deteriorated. Take the appropriate measure referring to the Owner's Manual.
"Keyless Unit Battery Low"		Caution	The 12 volt battery voltage to the keyless control unit drops to a point which could impair the keyless control unit performance. Take the appropriate measure referring to the Keyless Start System Owner's Manual.
"Keyless FOB Battery Low"		Caution	The key-fob battery voltage drops to a point which could impair key-fob performance. Take the appropriate measure referring to the Keyless Start System Owner's Manual.
"Check Keyless FOB"		Caution	The key-fob identification error. Take the appropriate measure referring to the Keyless Start System Owner's Manual.
"Check Shift Control"		Warning	Electronic shift control error. Take the appropriate measure referring to the Owner's Manual.
"Check Throttle System"		Warning	Electronic throttle error. Take the appropriate measure referring to the Owner's Manual.
"Check Control Unit C."		Warning	Electronic throttle and electronic shift control error. Take the appropriate measure referring to the Owner's Manual.
"Check 2nd Station"		Warning	2nd station error. Take the appropriate measure referring to the Owner's Manual.

Message	Icon	Status	Description/Remedy
"Check Station Setting"	-	Caution	The troll mode is not working properly. Refer to the Owner's Manual, check the activated Station, then reactivate the troll mode.
"Check Troll Condition"	-	Caution	Cannot switch to the troll mode. Refer to the Owner's Manual of how to activate the troll mode.

If any of the following caution messages are shown, consult your authorized Suzuki marine dealer.

- Check Keyless Communication
- Check ETV(P)
- Check ETV(P)_P/BCM
- Check ETV(P)_S/BCM
- Check ESA(P)
- Check ESA(P)_P/BCM
- Check ESA(P)_S/BCM
- Check ETV(C)
- Check ETV(C)_P/BCM
- Check ETV(C)_S/BCM
- Check ESA(C)
- Check ESA(C)_P/BCM
- Check ESA(C)_S/BCM
- Check ETV(S)
- Check ETV(S)_P/BCM
- Check ETV(S)_S/BCM
- Check ESA(S)
- Check ESA(S)_P/BCM
- Check ESA(S)_S/BCM
- Check LPS1(M)
- Check LPS1(M)_P/BCM
- Check LPS1(M)_S/BCM
- Check LPS2(M)
- Check LPS2(M)_P/BCM
- Check LPS2(M)_S/BCM
- Check Bat Low
- Check Bat Low_P/BCM
- Check Bat Low_S/BCM
- Check 2nd Ctf
- Check 2nd Ctf_P/BCM

13. INSTRUMENT DISPLAYS

- Check 2nd Ctf_S/BCM
- Check 2nd Com
- Check 2nd Com_P/BCM
- Check 2nd Com_S/BCM
- Check LPS1(S)
- Check LPS1(S)_P/BCM
- Check LPS1(S)_S/BCM
- Check LPS2(S)
- Check LPS2(S)_P/BCM
- Check LPS2(S)_S/BCM
- Check BCM Comm
- Check BCM Comm_P/BCM
- Check BCM Comm_S/BCM
- Check Throttle Only SW
- Check Select Switch
- Check 1 Lever Switch
- Check All PTT UP Switch
- Check All PTT DN Switch

14. WEATHER OPERATIONS

14.1 Weather Display Introduction

This chapter describes how to operate the built-in weather feature, TZ weather, and the optional FURUNO BBWX SiriusXM weather receiver. Your weather receiver provides weather information (U.S.A only), in analog and digital forms. The SiriusXM satellite radio is also available with a SiriusXM satellite radio subscription.

Your TZMAP9/13 or TZT9E/13E has a built-in TZ weather data, via Wi-Fi, and optional weather data via the FURUNO BBWX SiriusXM weather receiver.

Note: For BBWX SiriusXM weather receiver operations, see section 14.5.

How to select the weather display

The weather display is overlaid on the 2D chart plotter display. Select the weather display on the Home page by tapping the weather display icon.

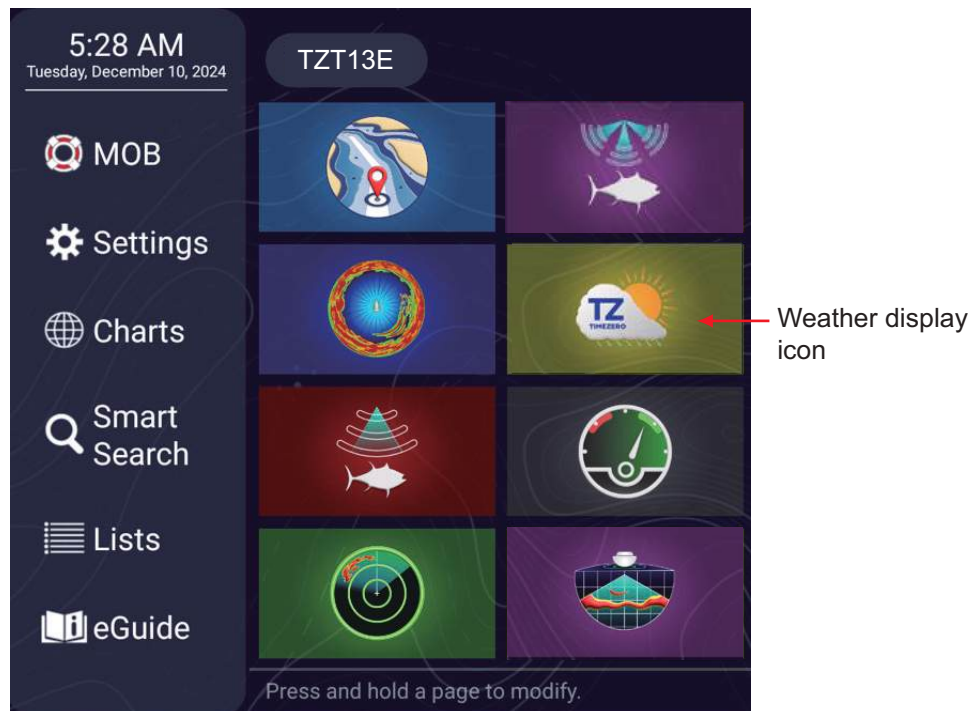

14.2 Weather Display Layers Menu

The Layers menu for the weather display has four tabs.

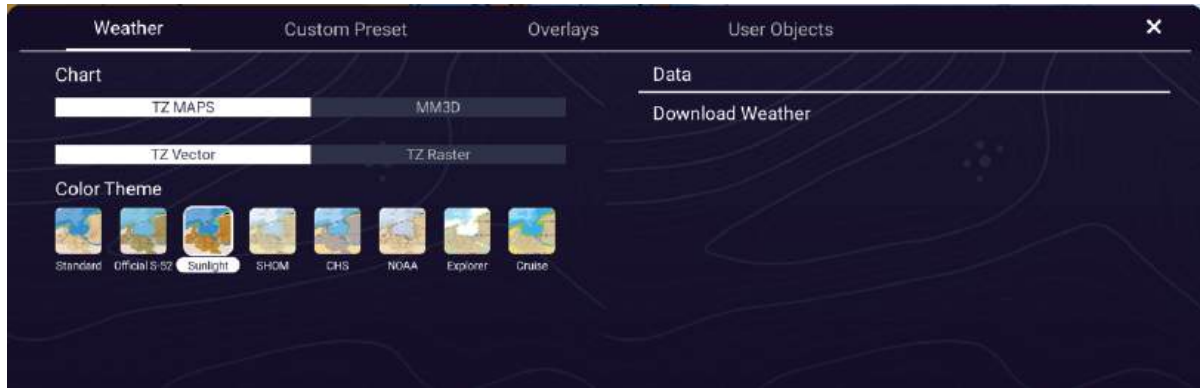

[Weather] tab



[Custom Preset] tab

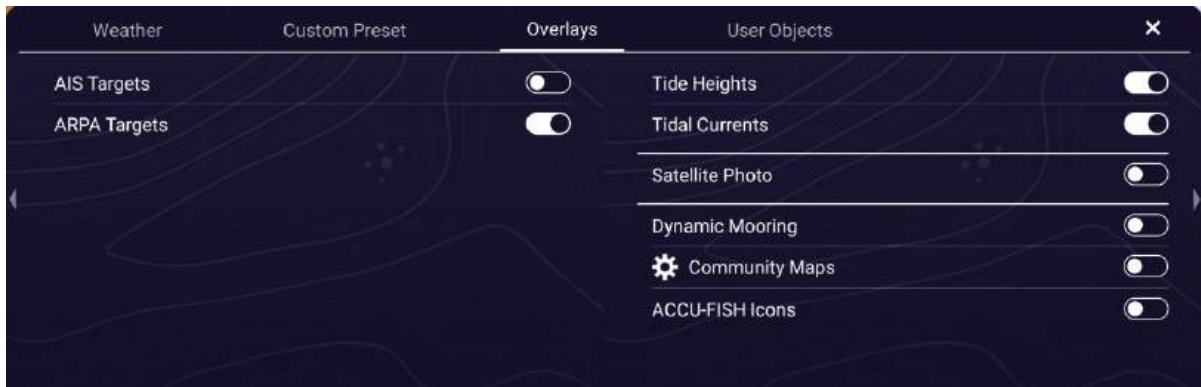

[Overlays] tab

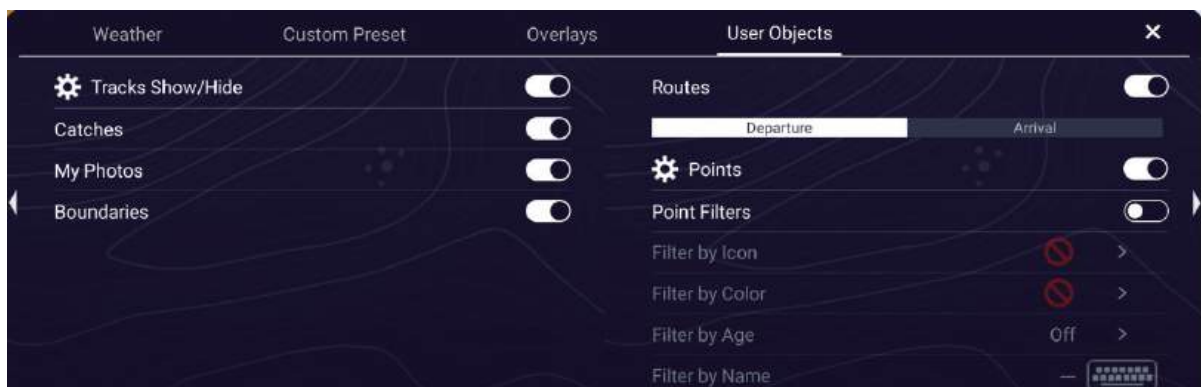

[User Objects] tab

14.3 TZ Weather

You can download the TZ weather data from the internet via Wireless LAN. See section 1.20 for how to connect to the Internet.

14.3.1 How to set up for TZ weather

1. Home page→[Settings]→[Weather]→[Tidal Update Interval].

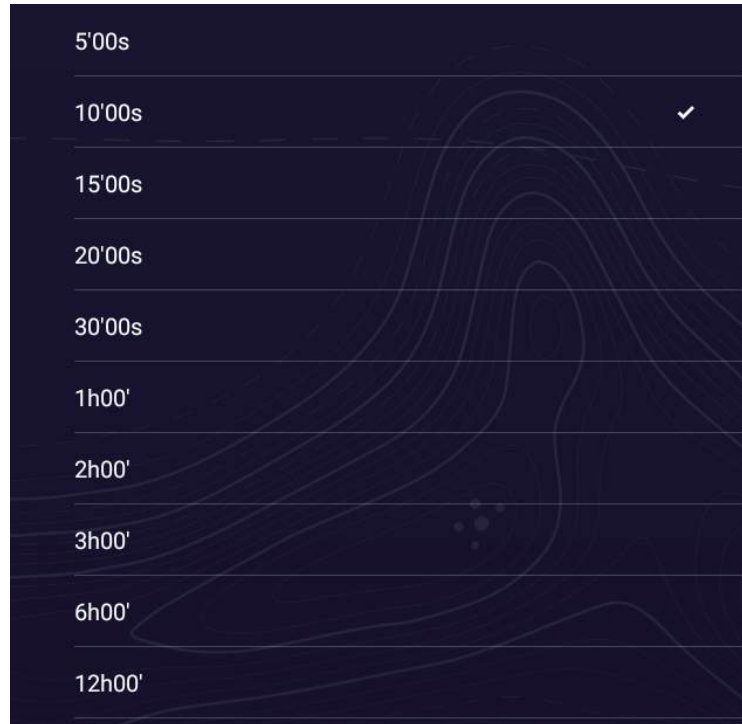

2. Tap the update interval (which determines how often tidal data are captured) to use for the tide icon.
3. Tap [<] to go back one layer in the menu.
4. Tap [Duration of Animation].

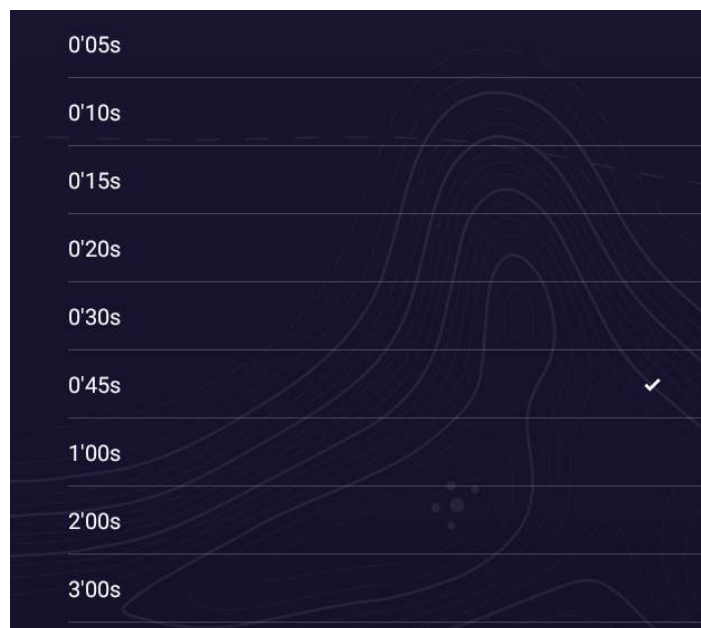

5. Tap the update interval for the animation. The larger the time, the slower the animation moves.

14. WEATHER OPERATIONS

6. Tap [<] to go back one layer in the menu.
7. Tap [Particle Trail Length].

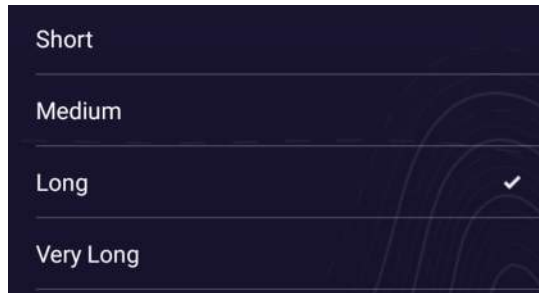

8. Select the length for the trail.

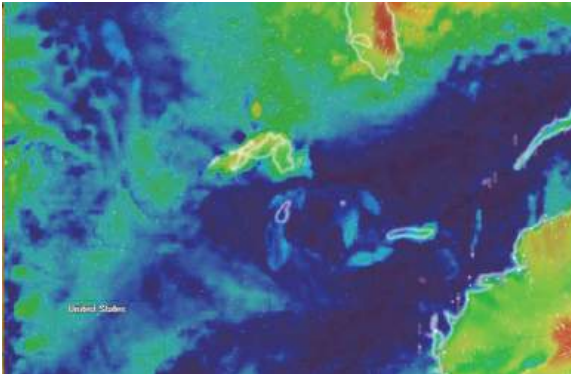

When [Short] is selected.

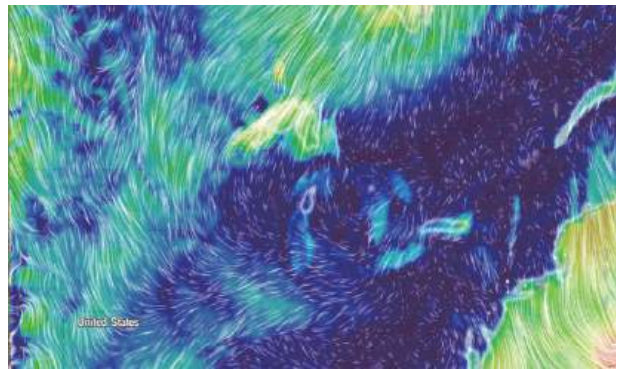

When [Very Long] is selected.

9. Tap [<] to go back one layer in the menu.
10. Use the slider bar for [Weather Color Transparency], or enter desired value with the software keyboard, and set the transparency of the sea surface on the screen (setting range: 0 to 80). When the [Air Temp.], [Clouds & Rain], [Waves], [Sea Surface Temperature], [Sea Surface Height], and [Chlorophyll] data is downloaded, the sea surface on the screen is colored according to the temperature. Set the transparency of the color on the screen.
11. Tap [×] on the title bar to finish and close the menu.

14.3.2 How to set the TZ weather download data size

1. Home page → [Settings] → [Weather].
2. Turn on [Restrict Download Size].
3. In the [Restricted Download Size in MB], use the software keyboard and set the maximum download size (setting range: 0.0 to 50.0 MB).
4. Tap [×] on the title bar to finish and close the menu.

14.3.3 How to download the TZ weather data

1. Home page→[Settings]→[General]→[Connectivity]→[Wireless LAN Settings], then check that [Wireless Mode] is selected to [Connect to existing LAN].
2. Turn on [Wireless].
3. After the internet connection is established, tap [x] on the title bar to finish and close the menu.
4. Layers menu→[Weather] tab→[Download Weather].

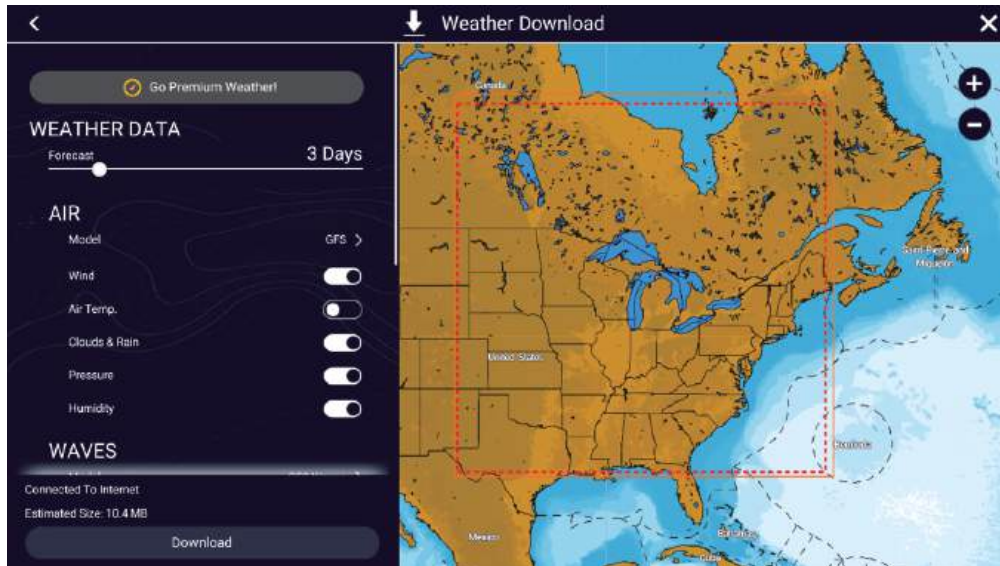

5. Drag the menu on the right side of the screen and move the frame on chart (dotted lines in red) to set the weather download area. The solid frame is the area that was previously downloaded.
6. Use the slider bar for [Forecast] under "WEATHER DATA" to select number of days to download (from 1 day up to 15 days).
7. Tap [Model] under "AIR", select the air data model, then tap [<] on the title bar to go back to the [Weather] menu.
8. Tap [Model] under "WAVES", select the wave data model, then tap [<] on the title bar to go back to the [Weather] menu.
9. Turn on all the weather informations (from [Wind] to [Chlorophyll]) as appropriate to download.
10. Use the slider bar for [Resolution] and set the range resolution. The higher the value (the further to the left the slider thumb on the slider bar is positioned), the lower the accuracy. Which data is less accurate is indicated below the slide bar.
11. Use the slider bar for [Time Interval] to set the time interval. The higher the value (the further to the left the slider thumb on the slider bar is positioned), the lower the accuracy. Which data is less accurate is indicated below the slide bar.
12. Tap [Download] at the bottom of the screen. During the downloading process, [Download] button changes to [Cancel] and the progress status is displayed at the bottom left corner of the screen. When the download is completed. [Cancel] changes to [Download Succeeded].

Automatic download

If the wireless LAN is connected during startup, the latest TZ weather data is downloaded automatically. The area of weather information that can be downloaded automatically is the area that was last manually downloaded. Do the following to get automatic downloading.

1. Home page→[Settings]→[Weather].
2. Turn on [Autodownload at boot].
3. Tap [x] on the title bar to finish and close the menu.

Note 1: If the wireless LAN is not connected at startup, automatic download starts once the connection is established.

Note 2: When multiple TZT9E/13Es are connected in the same network, the download only occurs at the unit designated as the "main" MFD. Multiple TZMAP9/13s cannot be connected in the same network.

14.3.4 How to display the TZ weather data

The TZ weather data display provides forecast data that includes [Wind], [Air Temp.], [Clouds & Rain], [Pressure], [Humidity], [Waves], [Currents], [Sea Surface Temperature],[Sea Surface Height], and [Chlorophyll].

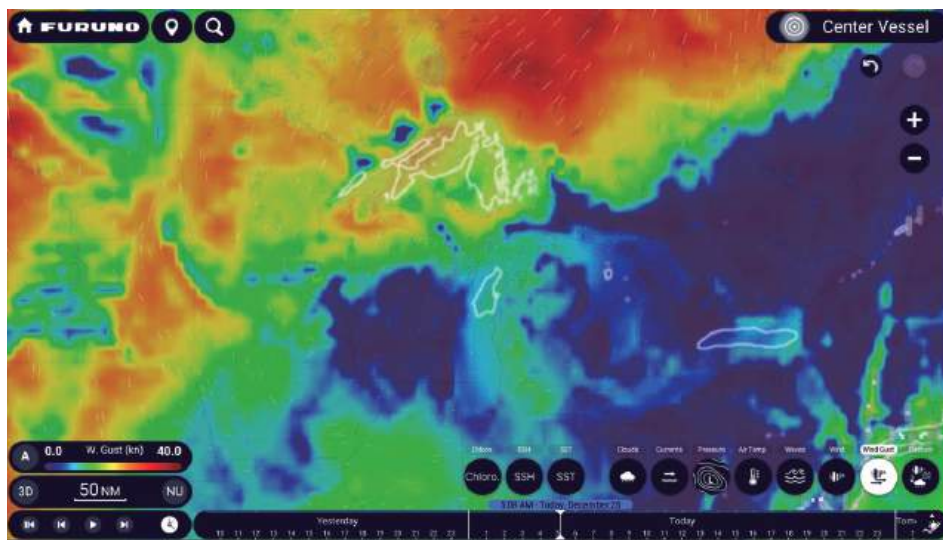

1. Tap the icon at the bottom of the screen to show weather data.



About Custom, see the "Custom settings" topic on the next page.

2. The animation display provides a visual presentation of the weather over time. To start the animation display, tap the play button icon on the animation bar at the bottom-left corner of the screen. The display shows the forecast for the date and time selected. Drag the time scale horizontally to select a time - left for past time, right for future time. To stop the animation display, tap [End Anim] (top right-hand corner of the screen).

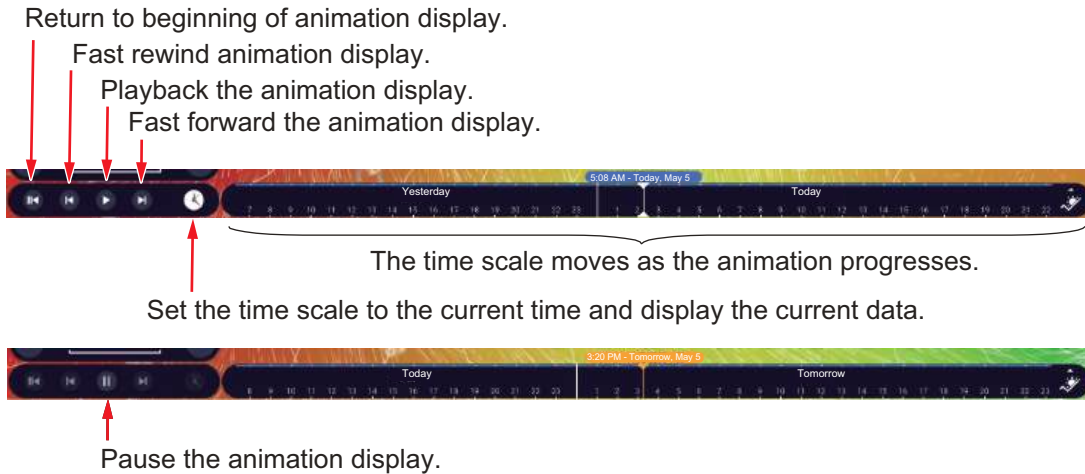

Custom settings

Tap the [Custom] icon at the bottom right-hand corner of the screen to change items in the [Custom Preset] tab of the Layers menu. You can customize the weather information as appropriate.

Menu item	Description	Option
[Weather as Particles]	Select the data to be displayed in the particle animation.	[-none-], [Wind], [Wind Gust], [Waves], [Current]
[Weather as Contour Lines]	Select which contour lines to display for which information.	[-none-], [Pressure], [Sea Surface Temperature], [Sea Surface Height], [Chlorophyll], [Current], [Wind], [Waves], [Wave Period]
[Weather in Color]	Select which information to display by color.	[-none-], [Air Temperature], [Clouds], [Wind], [Wind Gust], [Pressure], [Waves], [Wave Period], [Current], [Humidity], [Precipitation], [Sea Surface Temperature], [Sea Surface Height], [Chlorophyll]
[Weather as Text]	Select which information is to be displayed in text.	[-none-], [Air Temperature], [Wind], [Waves], [Current], [Precipitation], [Wind Gust], [Wave Period], [Clouds], [Pressure], [Humidity], [Sea Surface Temperature], [Sea Surface Height], [Chlorophyll]
[Wind Feathers]	Select whether to display/not to display the wind direction arrow.	ON, OFF
[Wind Gust]	Select whether to display/not to display arrows for the direction of gusts or not.	ON, OFF
[Ocean Current]	Select whether to display/not to display arrows for the direction of the ocean currents.	ON, OFF
[Waves]	Select whether to display/not to display the arrows for the direction of the waves.	ON, OFF

14.4 Meteogram Display

A meteogram display is a graphical display of the changing weather information such as temperature, waves, pressure, wind, etc. for a specific location. The visualization of weather changes can be useful in determining departure and arrival times. There are two methods to display the meteogram.

- Method 1: Tap on the weather display and select [Show Meteogram] from the pop-up menu.
- Method 2: Tap the  icon shown at the bottom right-hand corner of the weather display.

Tap the location icon and an orange circle appears on the screen. Drag the icon to the position where you want the meteogram to be displayed (the icon cannot be moved if the position is own ship position).

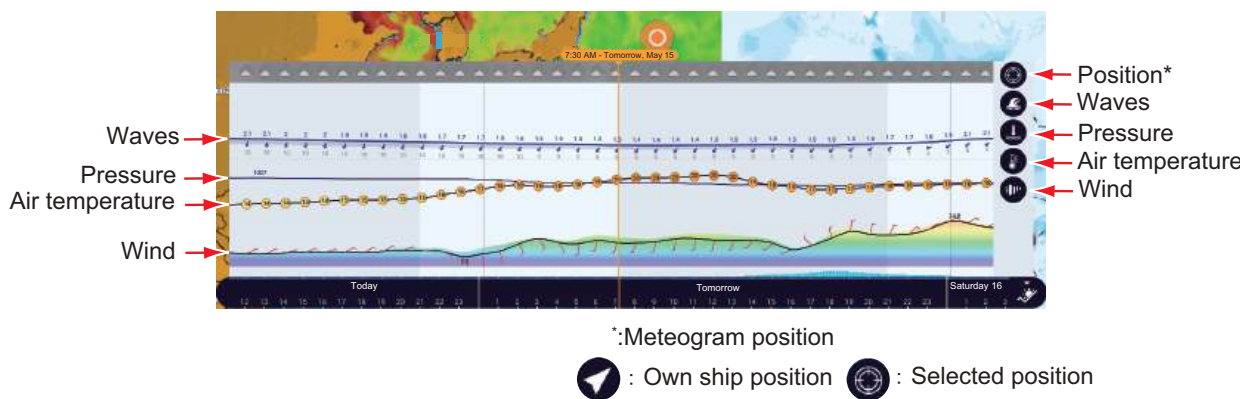

Example of the meteogram display

Tap desired position on the meteogram display to show the numeric information of the tapped position.

14.5 SiriusXM Weather

SiriusXM weather radar information and advanced weather information are available in North America with connection of the FURUNO BBWX SiriusXM weather receiver. SiriusXM satellite radio is also available with a SiriusXM satellite radio subscription.

Your system displays the current and forecasted marine weather information for your area. The weather information is updated in real time so that you have current weather information for any area in the U.S.

Information provided by the FURUNO BBWX SiriusXM weather receiver service is advisory in nature. You, the customer, agree to release FURUNO ELECTRIC CO., LTD., SiriusXM satellite radio INC, Navcast Inc. and WSI Corporation from any problems that occur from this service. And you acknowledge that you have read the conditions of your subscription agreement and agree to all the conditions of the subscription. If you do not have the subscription agreement, go to <https://www.siriusxm.com/marine-weatheragreement>, or call 1-855-796-9847 to have a copy sent to you.

You can put a point on the weather display. Tap the screen where to put a point, then tap [New Point] on the Pop-up menu.

Before using your SiriusXM satellite weather receiver...

- Purchase a SiriusXM satellite weather service subscription. Contact SiriusXM satellite radio INC. for additional information.
- Purchase a SiriusXM satellite radio service subscription. Contact SiriusXM satellite radio INC. for additional information.
- After installation of the FURUNO BBWX SiriusXM weather receiver, make sure to check the TZMAP9/13 or TZT9E/13E sensor list to make sure the BBWX appears in the sensor list.



Sensor List				
NETWORK SENSOR				
Name	Nickname	Version	IP	HostName
TZT16X (Me)	TZT16X	20231124.110950:20231124...	172.031.252.063	MF252063
BBWX4	BBWX4	XX.XX.XX.XX.XX	172.31.200.20	XXXXXXXX

If the receiver does not appear in the list, check the Antenna LED on the FURUNO BBWX SiriusXM weather receiver and the connection between the two units. The LED is solid violet when a normal antenna connection is detected, and off or flashing violet in case of antenna short circuit.

- Connect the FURUNO BBWX SiriusXM weather receiver and the TZMAP9/13 or TZT9E/13E displays then turn on both of those units. Your unit then receives WX data from the weather receiver, which takes approximately 30 minutes.

14. WEATHER OPERATIONS

How to select the SiriusXM weather display

Select the SiriusXM weather display on the Home page by tapping the SiriusXM weather display icon.



14.5.1 SiriusXM weather Layers menu

The Layers menu for the SiriusXM weather display has three tabs.



[Weather] tab

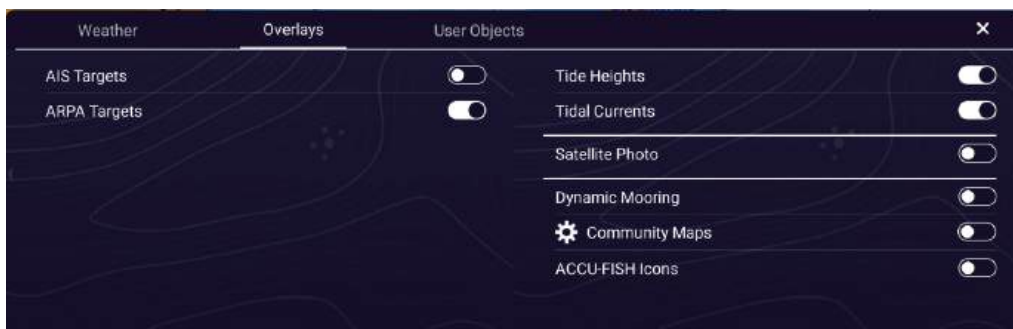

[Overlays] tab

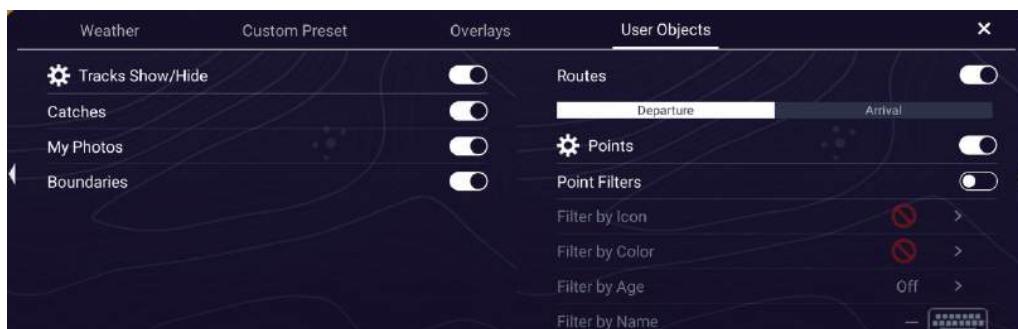

[User Objects] tab

14.5.2 How to set up for SiriusXM weather

Note: The BBWX connection is required for the following procedure.

1. Home page→[Settings]→[Weather].
2. Tap [SiriusXM Weather]
3. Tap [SiriusXM Weather Radar].
4. Tap the SiriusXM weather radar to use, [US Now Radar] (USA) or [CanadRad] (Canada). [US Now Radar] shows the type and level of precipitation. The amount of precipitation increases with level.

Precipitation indication on US Now Radar.

Weather radar color	Precipitation type	Level
Light green	Rain	15-19 dBz
Medium green	Rain	20-29 dBz
Dark green	Rain	30-39 dBz
Yellow	Rain	40-44 dBz
Orange	Rain	45-49 dBz
Light red	Rain	50-54 dBz
Dark red	Rain	over 55 dBz
Light blue	Snow	5-19 dBz
Dark blue	Snow	over 20 dBz
Light pink	Mixed	5-19 dBz
Dark pink	Mixed	over 20 dBz

Precipitation indication on CanadianRadar

Weather radar color	Level (mm per hour)
Transparent (low precipitation)	0.00 to 0.20 mm/hr
Light green	0.21 to 1.00 mm/hr
Medium green	1.01 to 4.00 mm/hr
Dark green	4.01 to 12.00 mm/hr
Yellow	12.01 to 24.00 mm/hr
Orange	24.01 to 50.00 mm/hr
Light red	50.01 to 100 mm/hr
Dark red	over 100.01 mm/hr

5. Tap [x] on the title bar to finish and close the menu.

14.5.3 How to display the SiriusXM weather data

[Wx Radar] (Weather radar)

NOWRAD and Canadian weather radar information are put on top of your chart (see subsection 14.5.2). To display the weather radar, turn on [Wx Radar] from the Layers menu→[Weather] tab.

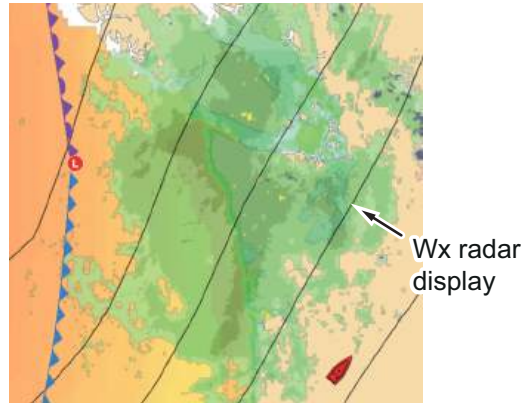

[Adv Wx Data] (Advanced weather)

The advanced weather display provides the following weather data: [Buoys], [City], [Storm], [Lightning], [Storm Tracks], and [Marine Zone]. For the icons of these data, see section 14.6.

1. Tap the screen to show the Pop-up menu, then tap [Adv Wx Data]. A Pop-up menu showing advanced weather data items appears.

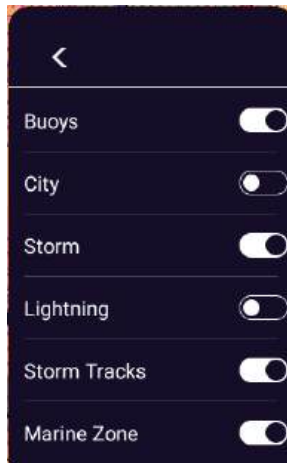

2. Turn weather items on or off as appropriate.

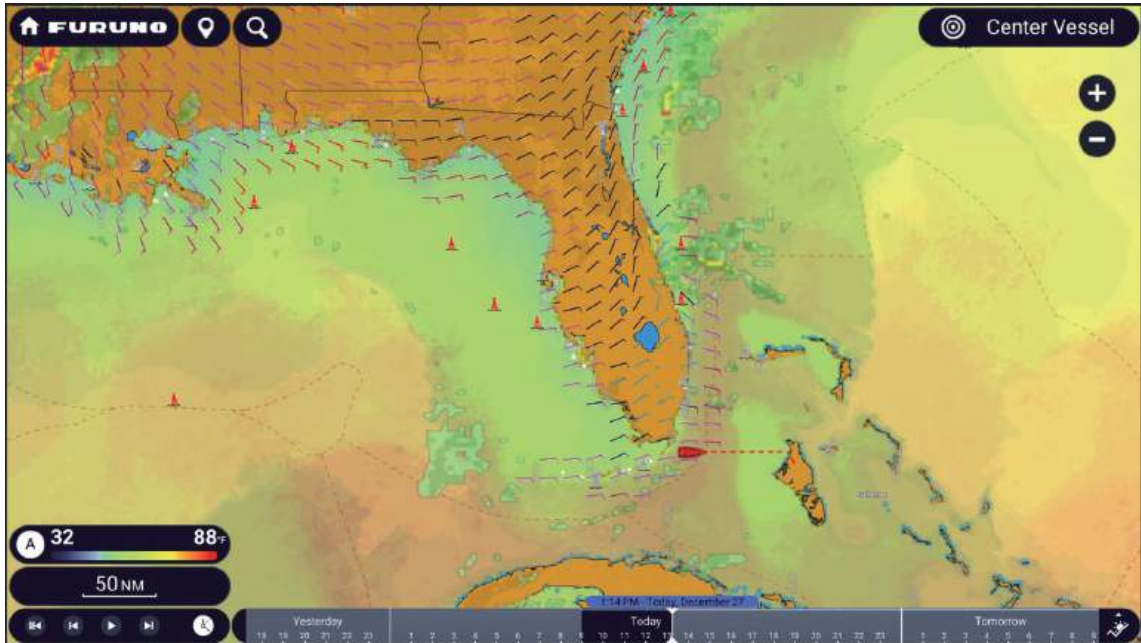







[Anim Radar] (Animation radar)

The animation radar display provides the past weather radar information. To show the animation radar display, tap the “replay” button at the bottom left corner. To stop the animation display, tap the icon again.

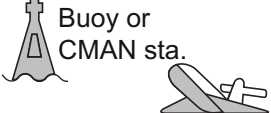
14.6 Weather Icons (SiriusXM Weather)

The table below shows the weather icons that appear on the SiriusXM weather display. You can show or hide these icons from the Pop-up menu, with [Wx Data].

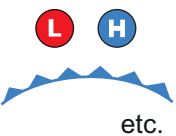
Icon	Meaning
	Storm cast
	Lightning
	Surface observation stations
	Wind
	City
	Currents
	Storm tracks
 etc.	Surface pressure

14.7 Weather Data (TZ Weather or SiriusXM Weather)

The table below shows the weather data available for displaying according to weather data server (TZ or SiriusXM weather).

Item	TZ	SiriusXM	Item	TZ	SiriusXM
Chlorophyll	Yes	No	Wind	Yes	Yes
SSH	Yes	No	Wind Gust	Yes	No
SST	Yes	Yes	Custom	Yes	No
Clouds	Yes	No	Buoys	No	Yes
Currents	Yes	No	City	No	Yes
Pressure	Yes	Yes	Storm	No	Yes
Air Temperature	Yes	No	Lightning	No	Yes
Waves	Yes	Yes	Storm Tracks	No	Yes

[Chloro.]: Shows planktons (chlorophyll). The more colorful the color bar (at bottom left corner of the screen), the greater the density of the plankton.

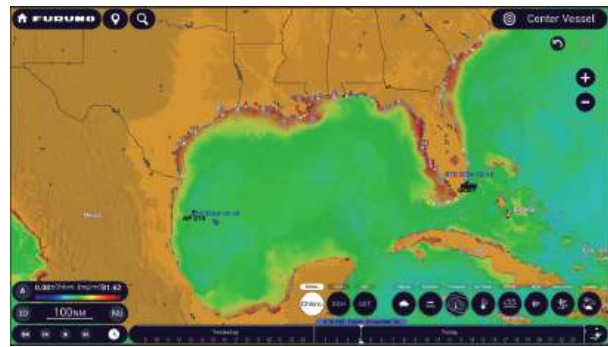

[SSH] (Sea Surface Height): Shows the sea surface height by colors. Higher sea surface is displayed in red, and small is displayed in yellowish green.

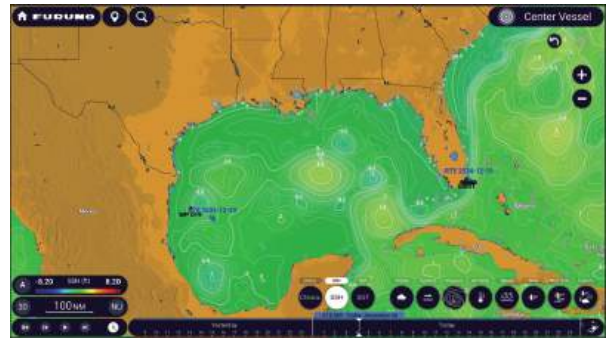

[SST] (Sea surface temperature): Shows the temperature of the sea surface by colors. The more colorful the color bar (at bottom left corner of the screen), the higher the sea surface temperature.

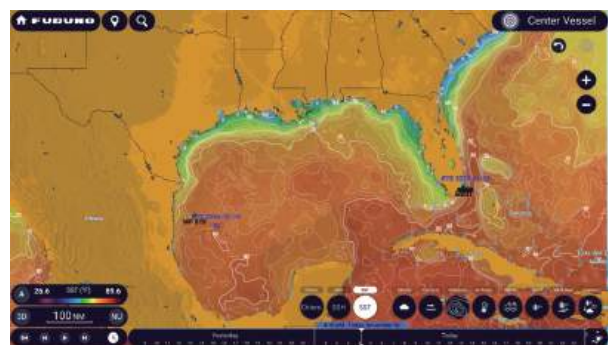

[Clouds]: The cloud forecast displays cloud movements. The more colorful the color bar (at bottom left corner of the screen), the cloudier the weather.

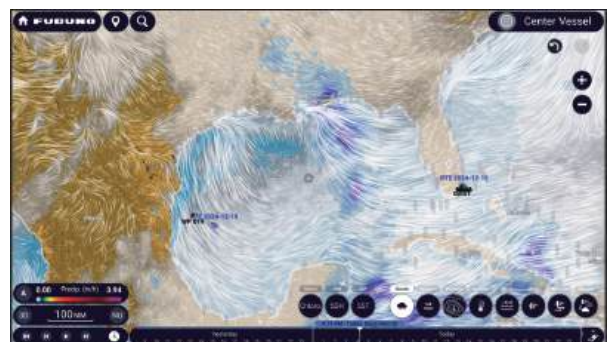

[Currents]: The current forecast displays the tidal current speed and direction. The more colorful the color bar (at bottom left corner of the screen), the faster the current speed.

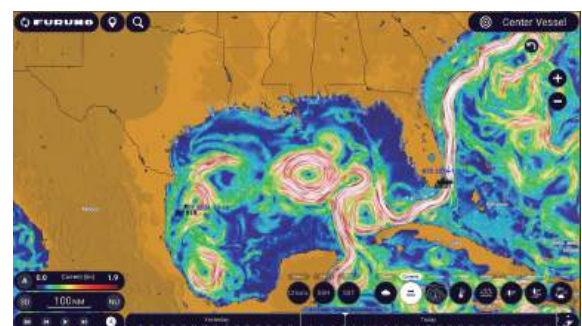

14. WEATHER OPERATIONS

[Pressure]: The pressure forecast displays surface pressure. The more colorful the color bar (at bottom left corner of the screen), the higher the pressure.

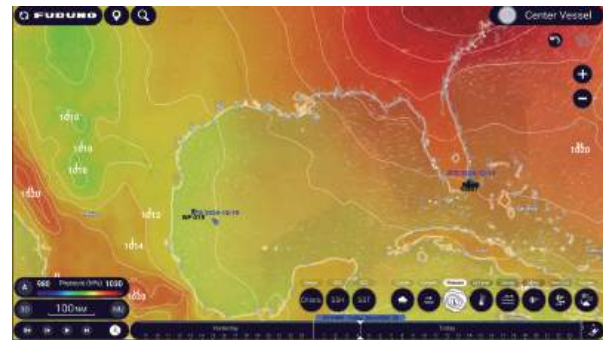

[Air Temp]: The air temp forecast displays the air temperature by color. The more colorful the color bar (at bottom left corner of the screen), the higher the air temperature.

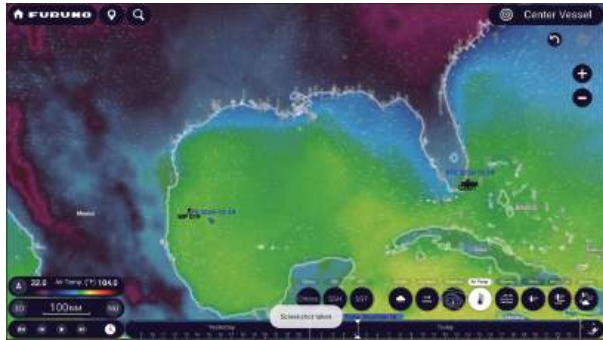

[Waves]: The waves forecast displays wave height with color. The more colorful the color bar (at bottom left corner of the screen), the higher the waves.

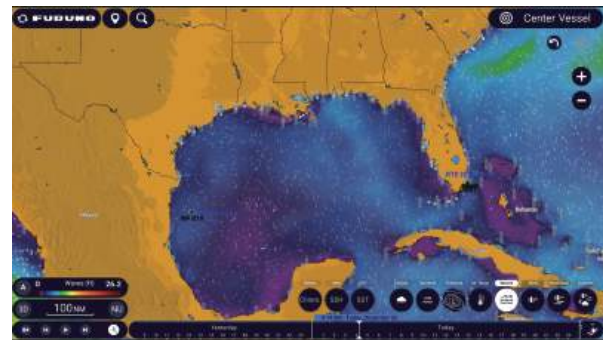

[Wind]: The wind forecast displays the wind speed by color. The more colorful the color bar (at bottom left corner of the screen), the faster the wind speed.

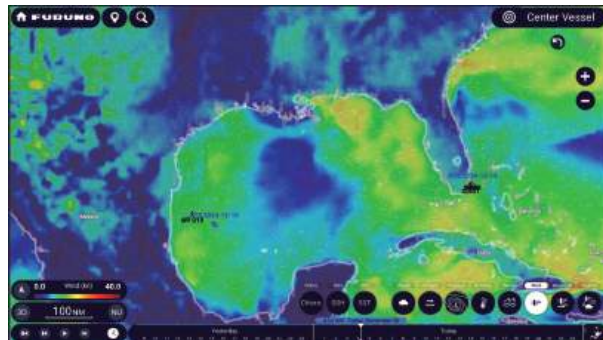

[Wind Gust]: The wind gust forecast displays the wind gust direction and speed by color. The more colorful the color bar (at bottom left corner of the screen), the faster the wind gust speed.

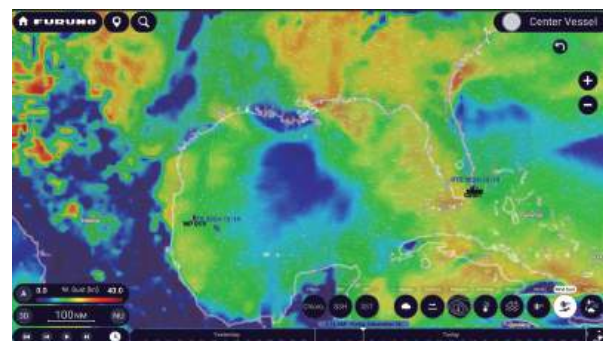

[Custom]: Displays arrows for wind, gusts, currents, and wave direction and speed. Customize the display as appropriate. The direction of the arrow indicates the direction of each data, and the thickness of the arrow (or the number of feathers in the case of wind) indicates the speed.

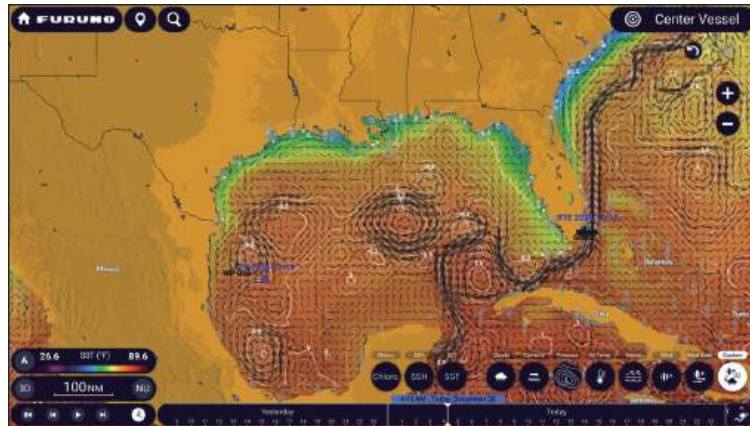

Custom display example

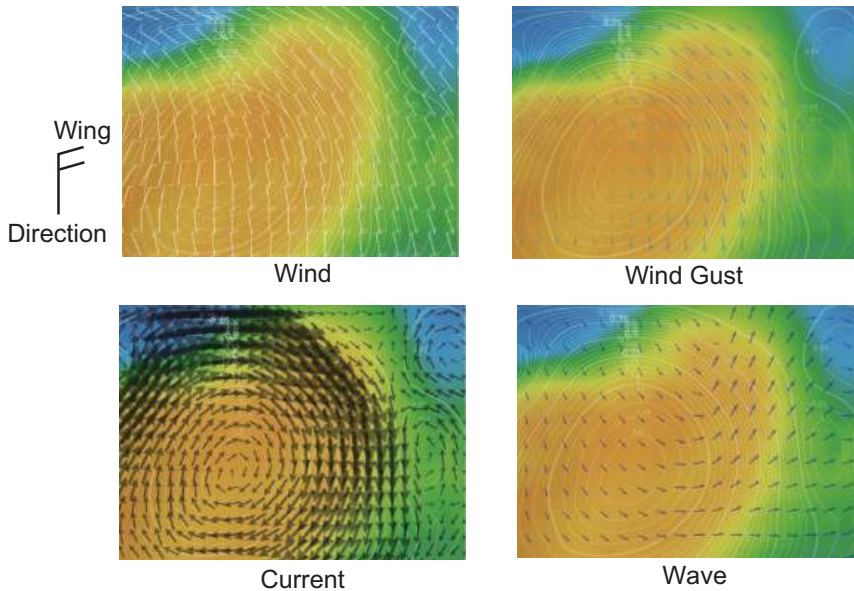

Color scale

At the bottom left corner of each weather data screen, the color scale (example; SST (sea surface temperature)) is displayed as shown in the right-hand figure, with the data displayed in the color corresponding to the numerical value. Each tap on [A] toggles between automatic and manual modes. In manual mode, tap the minimum or maximum value, and a slider bar appears on the right-hand side of the screen. Drag the slider thumb on the slider bar to change the value (see section 3.2.1). After the value is set, tap [Done] at the top right hand corner of the screen.

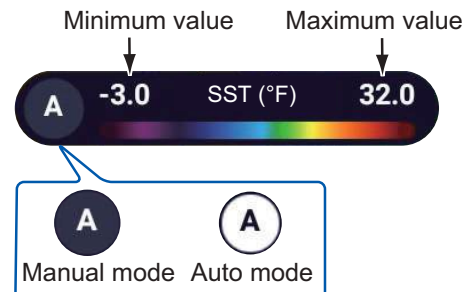

14.8 SiriusXM Weather Diagnostics

Your FURUNO BBWX SiriusXM weather receiver can be checked for proper operation as shown below.

1. Home page→[Settings]→[Weather]→[SiriusXM Weather].
2. Tap [SiriusXM Weather Diagnostic]. The count for each weather item is shown.



14.9 SiriusXM Satellite Radio

The SiriusXM satellite radio provides round-the-clock, 100% commercial-free music from every genre plus sports, news, talk and comedy.

14.9.1 How to activate the radio

Open the Slide-out menu, then tap the [SiriusXM Audio] icon to show or hide the audio control bar. See the next page for how to operate the radio controls.

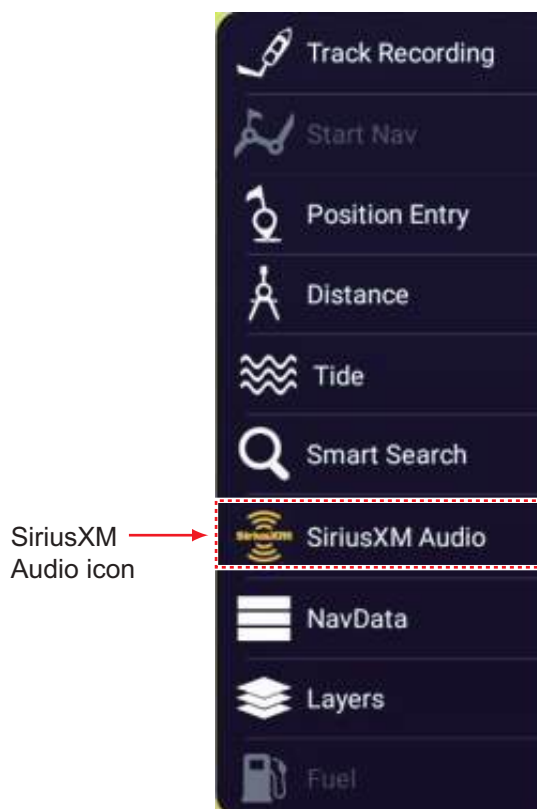

14.9.2 How to operate the radio controls

Full screen controls

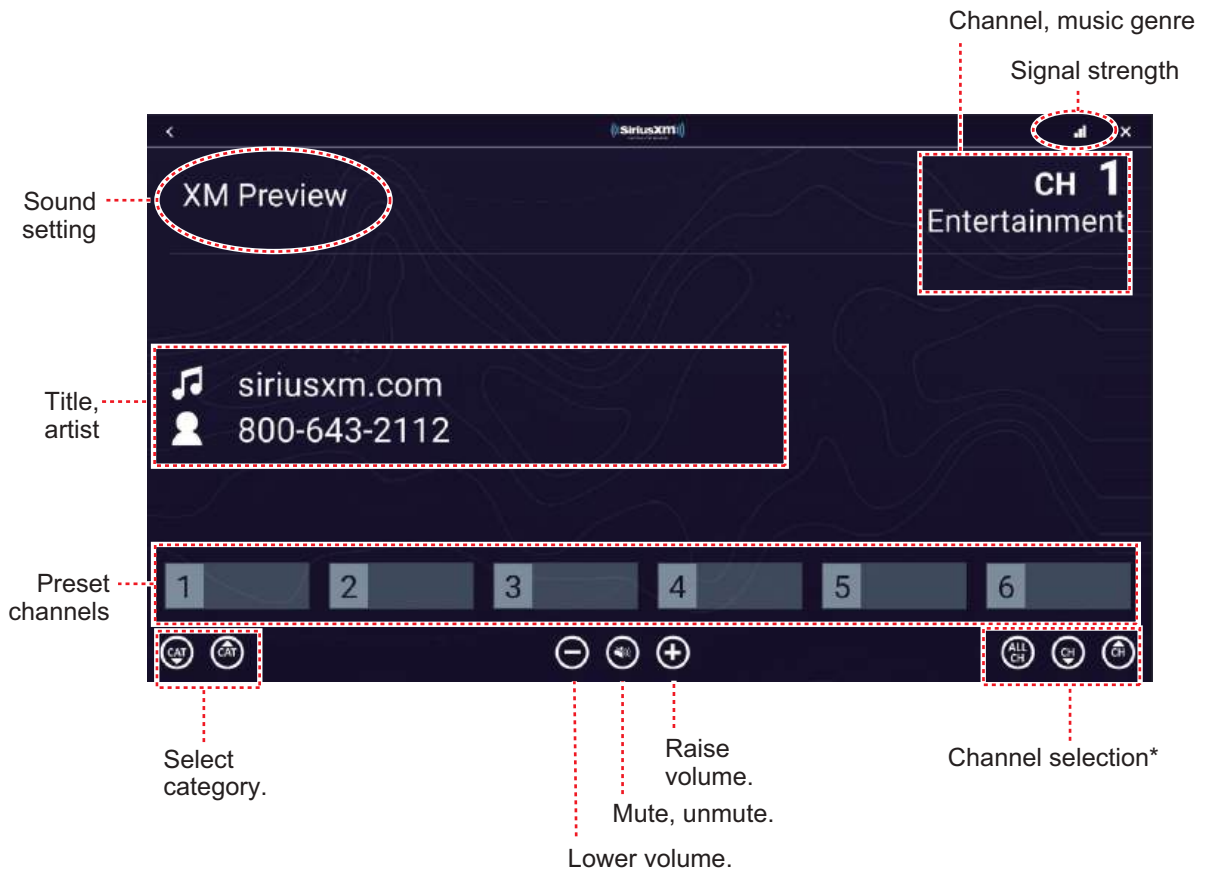

14

*: The channel ▲ and ▼ down buttons cycle through the available channels within the selected category. To allow the system to cycle through all categories and channels, tap the ALL CH button. Tap the button again to return to category-based channel selection.

Audio control bar controls

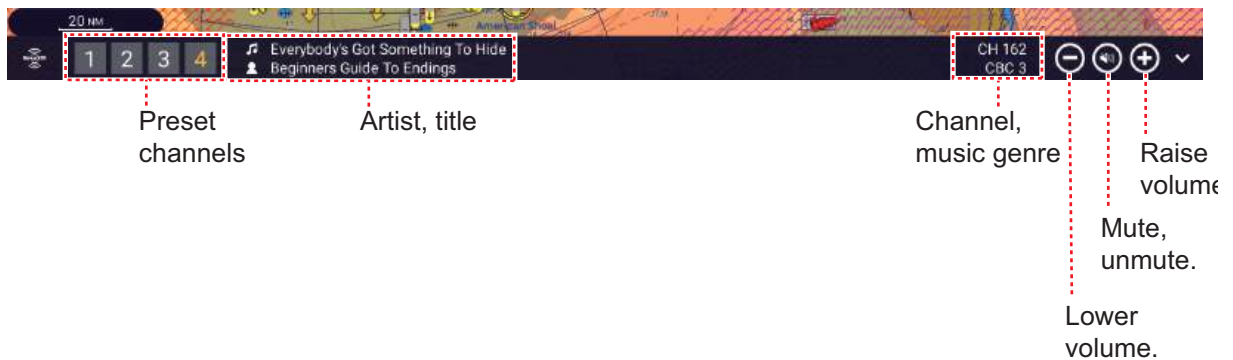

14. WEATHER OPERATIONS

14.9.3 Radio diagnostics

Your SiriusXM satellite radio can be checked for proper operation as shown below. This test is intended for the service technician.

1. Home page→[Settings]→[Initial Setup].
2. Tap [SiriusXM Radio Diagnostic]. The count for each weather item is shown.



14.10 Fish Mapping

This section provides an overview to the SiriusXM Fish Mapping features. For detailed information, see the Owner's Manual for Fish Mapping.

The Fish Mapping service provides you with real time fishing information to help get you to the spots where fish are most likely to be located. This service shows forecasted fishing hotspots directly on your display, using the following data.

- Fish recommendations
- Weed lines
- Sea surface height anomaly
- Sea surface temperature contours
- Sea surface temperature front strength
- 30m subsurface sea temperatures
- Plankton concentration contours
- Plankton front strength

14.10.1 How to show the fish mapping display

Open the Home page, then tap the fish mapping icon to show the fish mapping display.

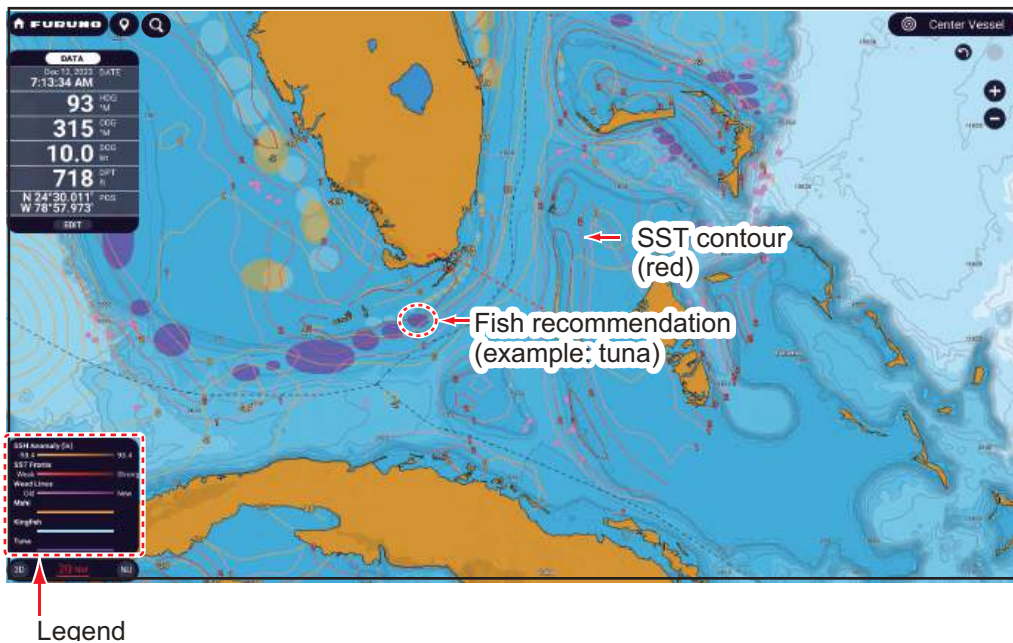
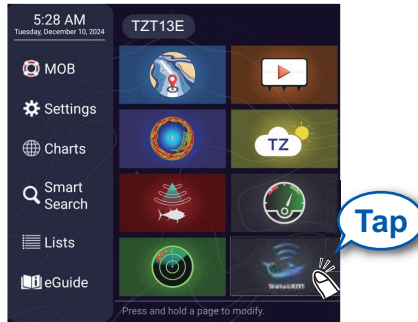

14.10.2 Fish mapping features

How to show or hide the fish mapping features

You can show or hide the Fish Mapping features with the items in the [Fish Mapping] tab in the Layers menu.

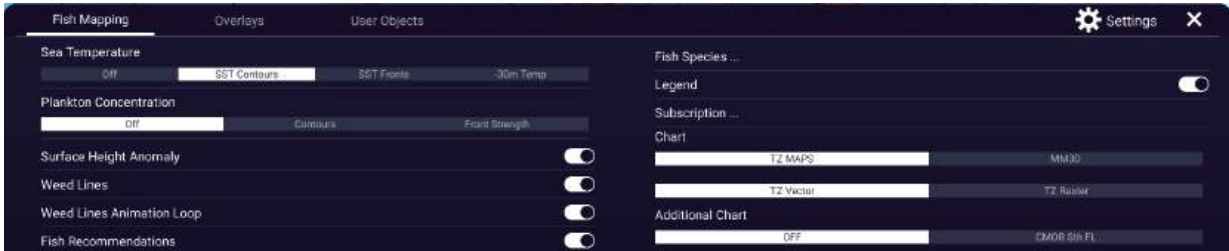

Fish mapping features description

[Sea temperature]

[SST Contours]: Show the water temperatures in your selected area. Use these contours to help locate your target species based on their preferred temperature range. The contours are colored in shades of red and the temperature values are shown in orange. Updated every three hours.

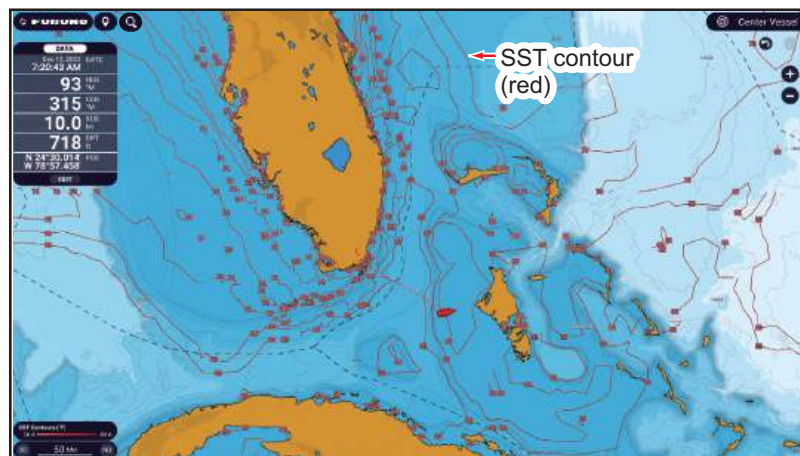

[SST Fronts]: Show estimated strength of ocean fronts. These “fronts” concentrate nutrients that attract bait fish and also create barriers to fish movement. The fronts are colored in shades of red and the front strengths, indicated with a numeral from 1 to 4 (highest) are shown in orange. Updated every 24 hours.

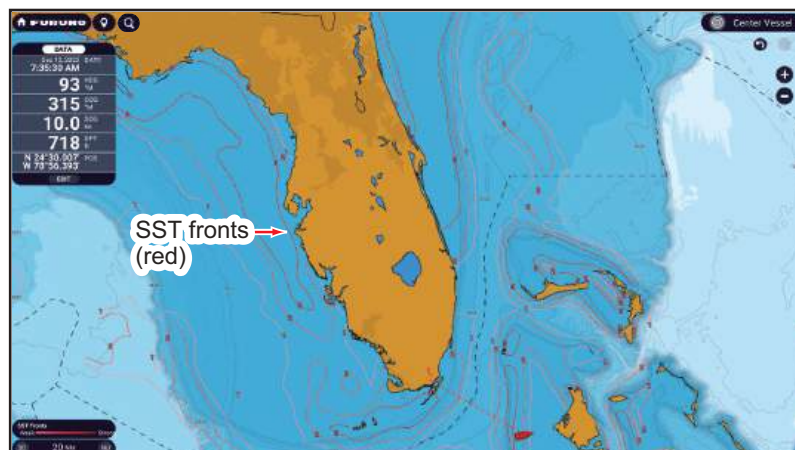

[-30m Temp]: Show the water temperature 30 meters below the surface. This feature allows you to identify areas with the preferred temperature range of your target game fish. The contours are colored in shades of red and the temperature values are shown in orange. Updated every 24 hours.

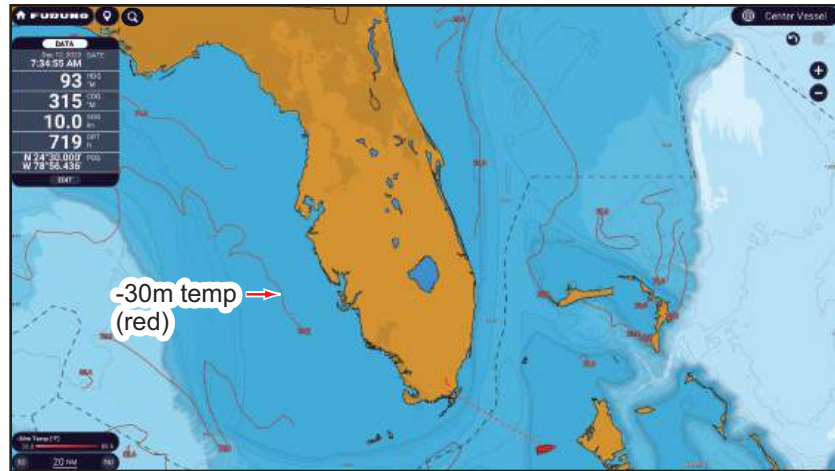

Plankton concentration

[Contours]: Show area of plankton concentrations. Plankton is the primary food source for most bait fish, which attract hungry game fish. You can find locations of plankton to identify favorable conditions for your target fish. Contours are shown in shades of green, and updated every 24 hours.

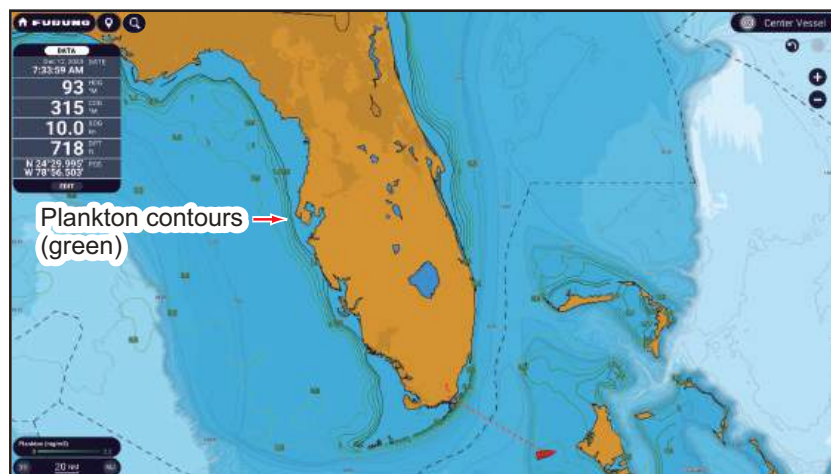

14. WEATHER OPERATIONS

[Front Strength]: View areas with strong plankton concentration bordering areas with relatively little or no plankton. Strong plankton fronts indicate where nutrient-rich water favorable for bait fish occurs next to clear, predator-preferred water. The fronts are colored in shades of green and the front strengths are shown in green. Front strength is indicated with a numeral from 1-4, 4 being the highest strength. Updated every 24 hours.

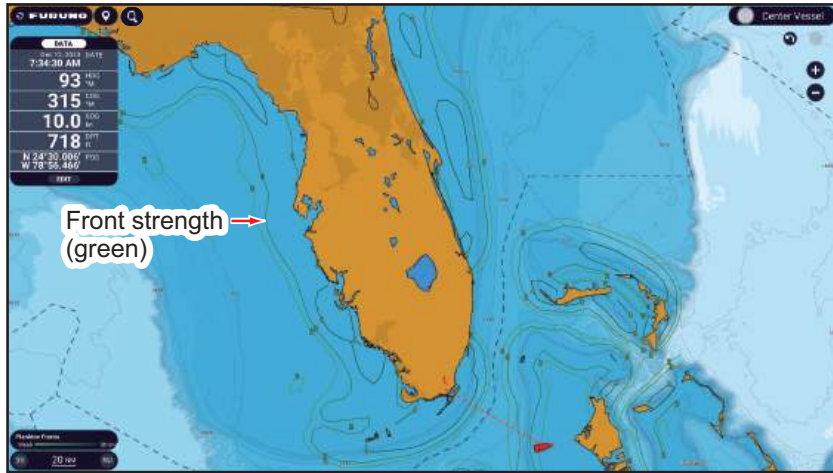

Sea surface height anomaly

View locations where the sea surface height is noticeably different than the surrounding area. Helps you locate “upwellings” - areas of nutrient-rich water that attracts bait-fish and game fish. Contours are shown in shades of orange, and updated every 24 hours.

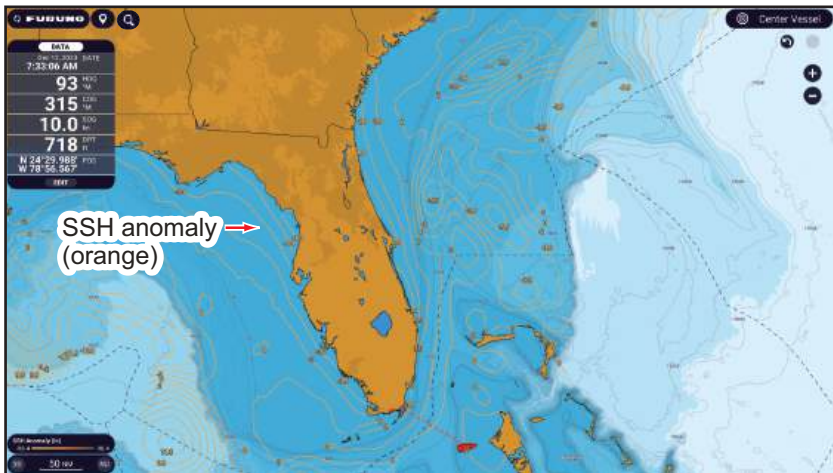

Weed lines, weed lines animation loop

Show concentrations of floating algae/plants. Floating algae/plants provide nutrients and cover for bait fish and shrimp and attract larger, predatory game fish. Weed lines are shown in shades of purple, and updated every 24 hours. The **weed lines animation loop** shows weed lines drift and shift over three days time.

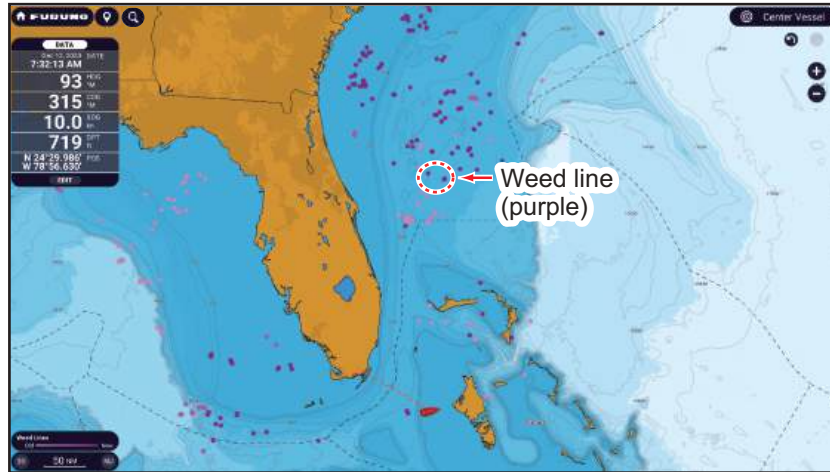

Fish recommendations

Show locations for finding specific types of game fish, based on data-driven analysis. The locations are overlaid on your chart and can be viewed in combination with other features. Each fish species is shown in a distinct color. Updated twice per week.

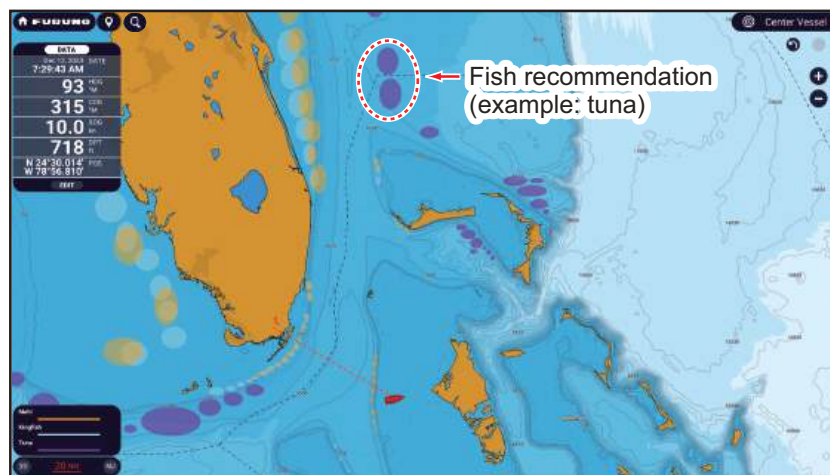

Fish species

Show or hide fish recommendations. Tap to show the [Fish Species Selection Window]. Turn fish species on or off as required.



14. WEATHER OPERATIONS

Legend

The legend is shown at the bottom left corner of the display, and provides a key to all the Fish Mapping features currently shown. You can show or hide the legend with [Legend].

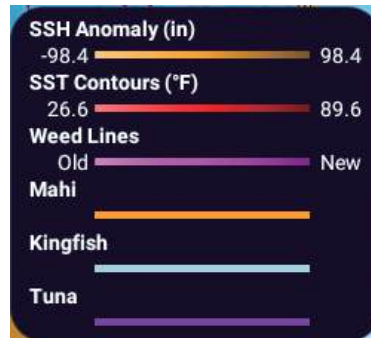

Subscriptions

Show the date and time the Fish Mapping features were updated and received.

Marine Fish Mapping		
	Updated	Received
Fishing Recommendations	12/11/2023 8:09 PM	00:11
Plankton Concentration Contours	—	00:00
Plankton Front Strength	—	00:13
30m Sub-Surface Temp. Contours	—	00:11
Sea Surface Height Anomaly	12/12/2023 4:35 AM	00:12
Sea Surface Temperature Contours	12/12/2023 6:01 AM	00:08
Sea Surface Front Strength	—	00:11
Weed Lines	12/11/2023 6:46 AM	00:28

Chart

Select the chart type to use among [TZ MAPS], [TZ Vector], [MM3D], [TZ Raster].

Additional Chart

Select additional chart if available.

14.10.3 How to show fish mapping data

Tap a Fish Mapping feature to show its data in the pop-up display. Below are sample Fish Mapping data.

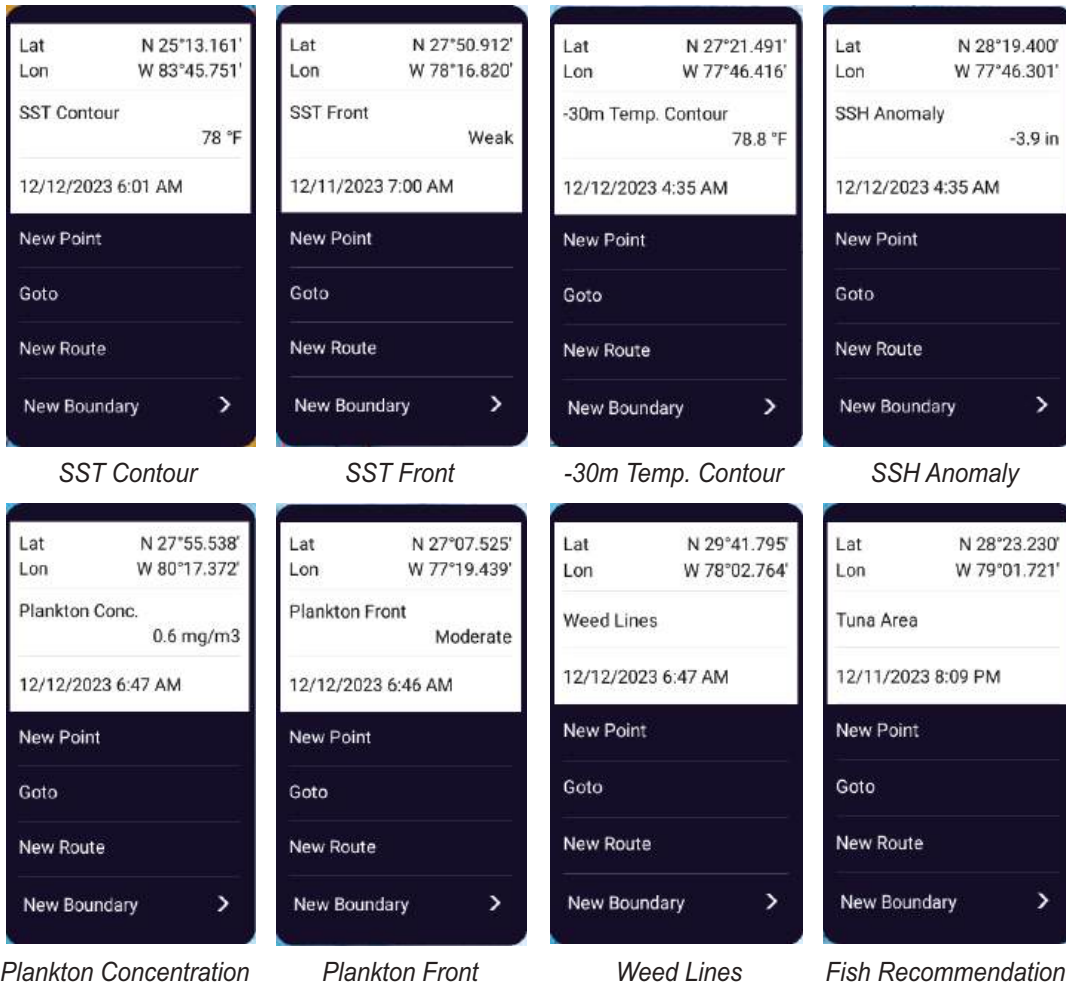

14.10.4 How to change fish mapping settings

You can change the range for each Fish Mapping feature. Open the [Weather] menu, then select [Fish Mapping Settings].

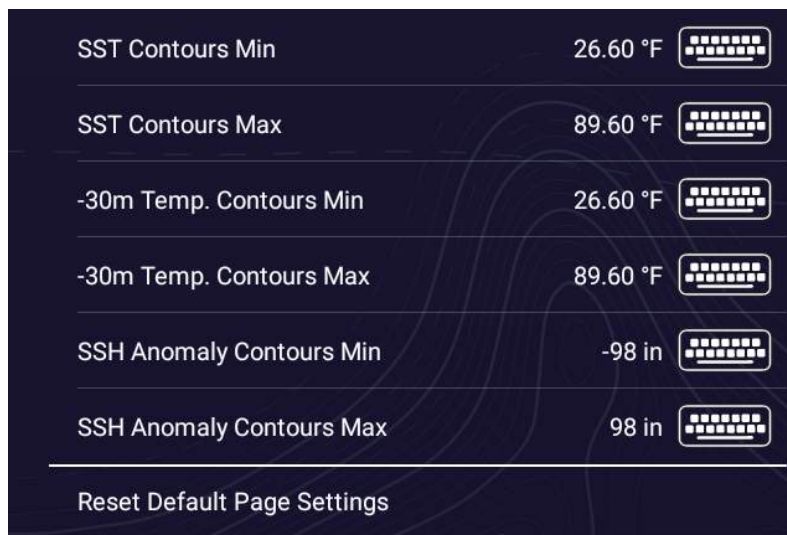

14. WEATHER OPERATIONS

14.10.5 How to show or hide overlays

Open the Layers menu, then tap the [Overlays] tab. show or hide overlays as necessary.

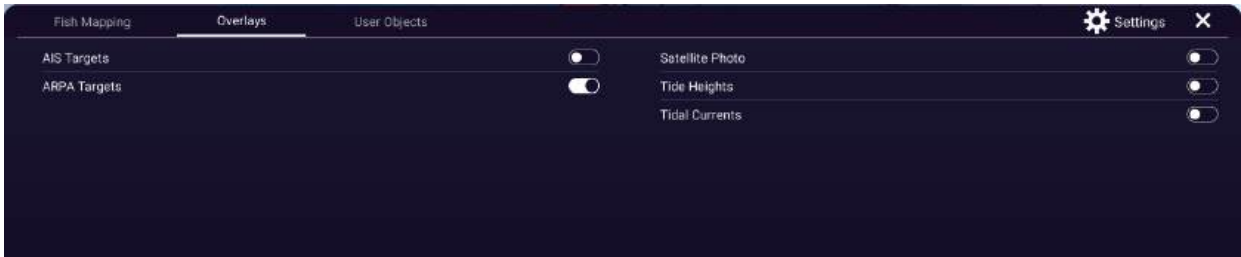

14.10.6 How to show or hide user objects

Open the Layers menu, then tap the [User Objects] tab. show or hide user objects as necessary.

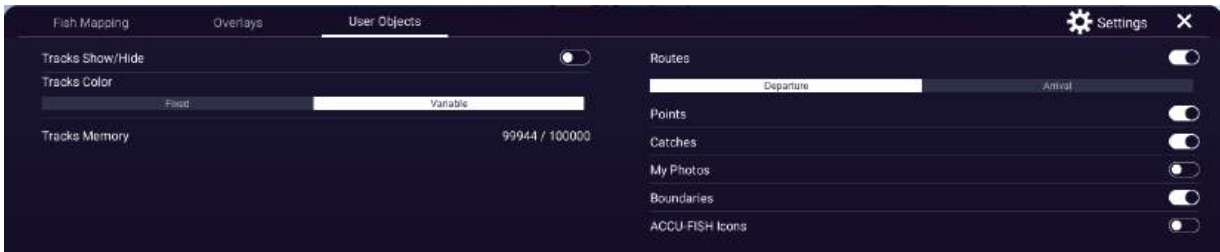

15. AIS, DSC MESSAGE

Note 1: Incidents and accidents exploiting the AIS/DSC signals are reported. Never rely solely on the received signals and messages on the screen. Always maintain a vigilant watch while underway.

Note 2: Due to the specifications of the NMEA 2000, the transmission data can be intercepted and tampered. Check regularly to make sure that no suspicious devices are connected to the NMEA 2000 network.

15.1 What is AIS?

The AIS (Automatic Identification System) continuously transmits the identification and position of your ship to AIS-equipped ships within VHF range. All such ships also receive data from other AIS-equipped ships and displays their positions and other relevant information. The AIS broadcasts this information over a VHF transceiver. The information is as shown below.

- Position
- Speed over ground (SOG)
- Heading
- Rate of Turn
- Name of ship
- Course over ground (COG)
- Call Sign



15.2 How to Show or Hide the AIS Symbols

1. On the radar display or chart plotter display, open the Layers menu.
2. Tap the [Overlays] tab.
3. Turn [AIS Targets] on or off.





Note: AIS symbol size, including text font size, can be adjusted ([Settings]→[General]→[This Display]→[Scale & Layout] menu (see section 16.1).

15.3 AIS Target Symbols

Target type	Symbol	Description
Activated AIS target	<p>Symbol color</p> <p>Blue: Class A AIS target</p> <p>Green: Class B AIS target</p> <p>Blue (hollow): BFT AIS target (see next page)</p>	<p>COG is indicated on the symbol with a dashed line.</p> <p>Note: An AIS symbol that has a "TX marker" above it indicates that vessel has transmitted an AIS message.</p> <p>TX marker (callout)</p>

Target type	Symbol	Description
Dangerous AIS target	Color: Red 	The target whose CPA and TCPA are smaller than the CPA/TCPA alarm setting is indicated as a dangerous AIS target.
Lost AIS target	 <u>Symbol color</u> Blue: Class A AIS target Green: Class B AIS target Blue (hollow): BFT AIS target (see next page) <u>Cross mark color</u> Red	An AIS target becomes a lost target if a signal is not received from the AIS target for x* minutes. The lost target symbol is erased if a signal is not received for an additional x* minutes. *: The time depends on the AIS transponder. Check the operator's manual for your AIS transponder for information about lost targets.
No CPA/TCPA target	 Class A AIS (Symbol color: Blue) Class B AIS (Symbol color: Green)	An AIS symbol is shown in broken lines in the following cases: <ul style="list-style-type: none"> • Invalid SOG or COG from AIS target. Additionally, if both COG and heading are invalid, the broken line symbol points north. • If either your own ship's SOG or COG is an invalid value, all Class A and Class B AIS symbols displayed on the screen will be displayed as broken lines.

Note: This unit is equipped with the Blue Force Tracking (BFT) function. Other AIS symbols that may appear are shown in the table below.

Symbol	Meaning	Symbol	Meaning
	AtoN		Aircraft
	Base Station		SART

15.4 Proximity AIS Target Alarm

The proximity AIS target alarm alerts you when an AIS target is within the distance you specify. When an AIS target is within the distance set, the indication [Proximity AIS Alarm] flashes in the Status bar and the audio alarm sounds. The alarm activates for both displayed and hidden AIS targets.

1. Home page → [Settings] → [Targets].
2. Turn on [Proximity AIS Target Alarm].
3. Tap [Proximity AIS Target Alarm Value] to show the software keyboard.

4. Set the alarm value, then tap [✓].
5. Tap [×] on the title bar to finish and close the menu.

Note: To cancel the proximity AIS target alarm, turn it off in step 2.

15.5 How to Ignore Slow Moving AIS Targets

The proximity AIS target alarm may often sound in areas of heavy vessel traffic. You can prevent frequent release of the alarm against slow, non-threatening targets by specifying the maximum target speed that triggers the alarm. Any target whose speed is lower than set here does not trigger the alarm.

1. Home page→[Settings]→[Targets].
2. Tap [Ignore AIS Targets Slower Than...] to open the software keyboard.
3. Set a speed, then tap [✓]. Any AIS target whose speed is lower than set here is ignored.
4. Tap [×] on the title bar to finish and close the menu.

15.6 How to Display AIS Safety Messages

When you receive an AIS safety message (addressed or broadcast) from an AIS transponder-equipped vessel, the Status bar displays the flashing message "AIS: New Text Message". Tap the Status bar to display the message. The AIS symbol for the vessel that transmitted the message is put at the center of the screen and a context-sensitive window appears, showing the AIS safety related message. You can delete the message by tapping [Delete Message]. If you do not require AIS message notification, turn off [AIS Message Notification] in the [Targets] menu.

15

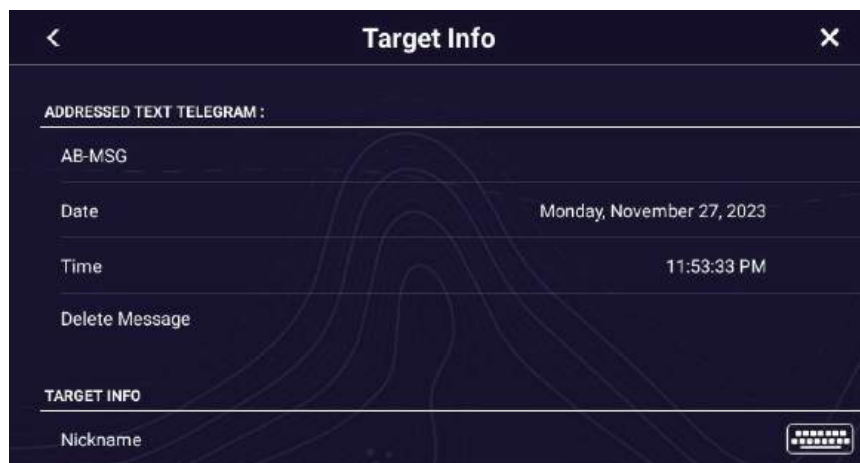

15.7 How to Display AIS Target Data

Tap an AIS target (chart plotter or radar display) to display the basic information in the Pop-up menu.

For detailed information, tap the target, then tap [Info] on the Pop-up menu to show the [Target Info] window.

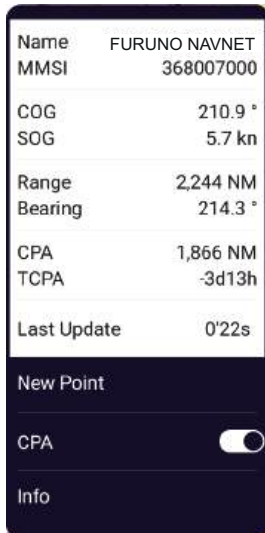

Simple info

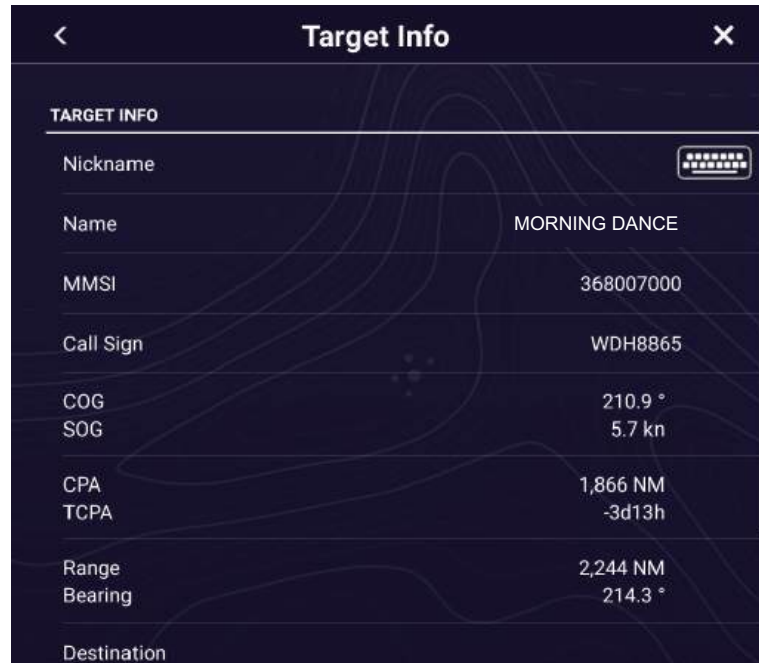

Detailed info

15.8 How to Show or Hide the Target IDs

You can show or hide the target ID of AIS targets.

1. Home page→[Settings]→[Targets].
2. Turn [Display Target IDs] on or off.
3. Tap [×] on the title bar to finish and close the menu.

15.9 AIS List

The [AIS] list provides information about the AIS targets you are receiving navigation data from.

How to open the AIS list

To show the AIS list, Home page→[Lists]→[AIS]. You can tell the type and status of an AIS target by the color of the mark that appears on the left side of the list.

Blue: Class A AIS transponder.

Green: Class B AIS transponder.

Red: Dangerous AIS target.

Black: Data is not reliable.

You can sort the list with the list sort buttons on the title bar.

[Name]: AIS targets sorted in alphanumeric order.

[Range]: AIS targets sorted by range in ascending order.

[CPA]: AIS targets sorted by CPA in ascending order.

Note 1: To update the list, tap [Refresh].

Note 2: AIS SART targets appear at the top of the list.

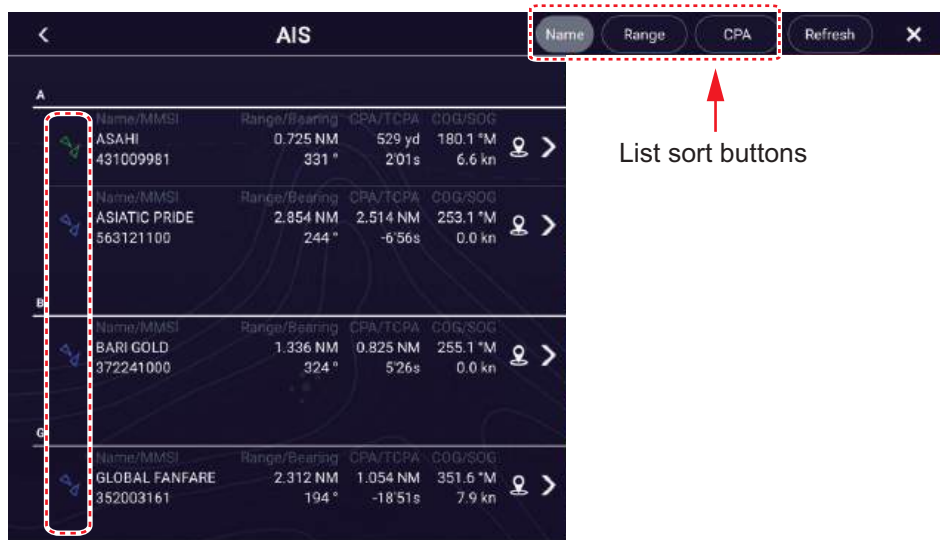

Vertical bar

List sort buttons

How to display the detailed information for an AIS target

To view detailed information about an AIS target, tap the appropriate target in the AIS list.

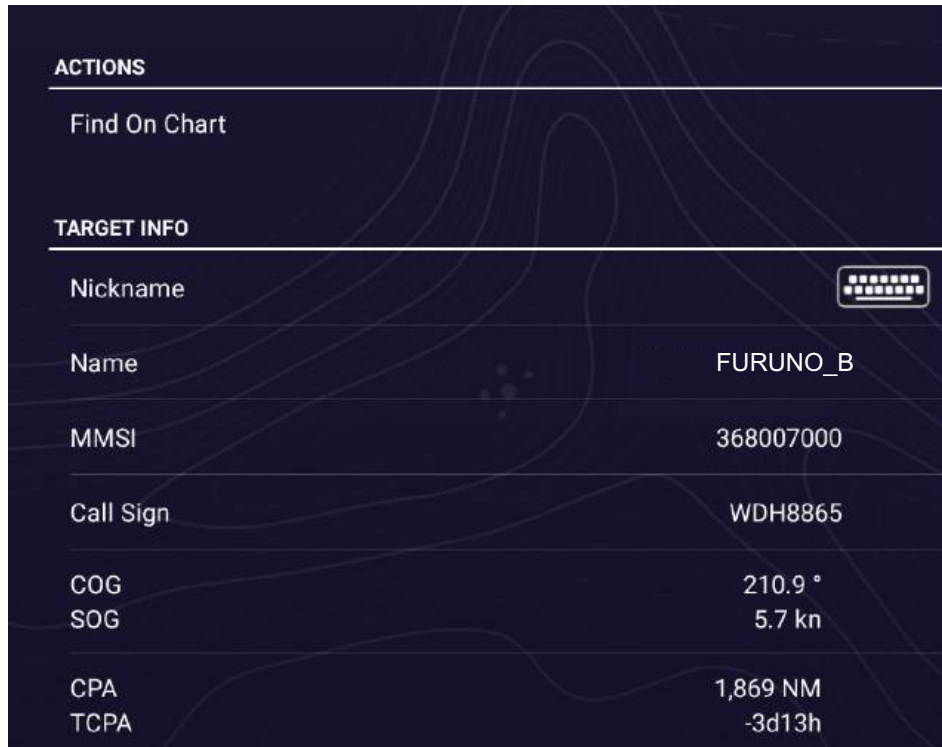

Scroll to see other items.

How to find an AIS target on the chart plotter display

Tap the AIS target on the [AIS] list, then tap [Find On Chart]. The target is placed at the center of the chart plotter display.

How to edit an AIS nickname

1. On the [AIS] list, then tap the AIS target to edit its nickname.
2. Tap [Edit Nickname] to display the software keyboard.
3. Enter the nickname, then tap [✓] to finish. You can use a maximum of 20 alpha-numeric characters.
4. Tap [×] on the title bar to finish and close the menu.

15.10 AIS SART Display

When an AIS SART is received (including re-received ones), the message "AIS SART Alarm" appears flashing in the Status bar. Tap the Status bar to acknowledge the message. Then, the AIS SART is put at the center of the screen and the context-sensitive shown right appears. To set the AIS SART as destination, tap [Goto] on the context-sensitive.

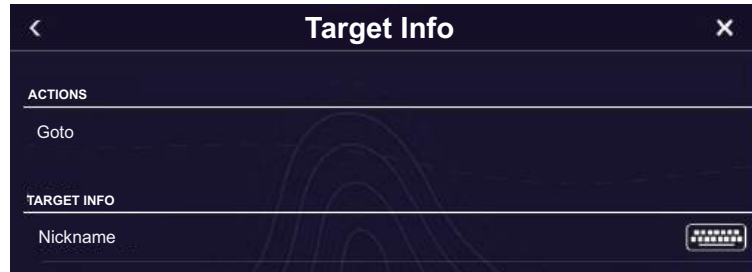

15.11 CPA/TCPA Alarm

This alarm helps you keep your ship away from collision by warning of targets on a collision course. The ARPA continuously monitors the predicted range at the Closest Point of Approach (CPA) and predicted time to CPA (TCPA) of each tracked target. When both the predicted CPA and TCPA are less than their CPA/TCPA alarm values, the target symbol of the vessel on a possible collision course turns red, the audio alarm sounds and the message "CPA/TCPA Alarm" appears flashing in the Status bar.

Make sure that the gain, sea and rain controls are correctly adjusted before you use this alarm. CPA/TCPA alarm ranges must be set correctly according to the size, tonnage, speed, turning performance and other characteristics of your ship.

Note: This function cannot be used if [CPA/TCPA Alarm] in the [Targets] menu is set to [Risk Visualizer] on a TZT9E/13E series unit in the same network.

How to set the CPA/TCPA alarm

1. Home page → [Settings] → [Targets] → [Collision Alarm].
2. Tap [CPA/TCPA], then tap [<] to go back one layer in the menu.
3. Tap [CPA Alarm Value] to display the software keyboard. Set the value (distance) then tap [✓] to finish.
4. Set [TCPA Alarm Value] similarly to [CPA Alarm Value].
5. Tap [x] on the title bar to finish and close the menu.

How to acknowledge the CPA/TCPA alarm

When the CPA and TCPA of an AIS target are within the CPA/TCPA alarm range, the message "CPA/TCPA Alarm" appears flashing in the Status bar and the audio alarm sounds. To stop the flashing message and silence the audio alarm, tap "CPA/TCPA Alarm" on the Status bar.

How to deactivate the CPA/TCPA alarm

1. Home page→[Settings]→[Targets]→[Collision Alarm].
2. Tap [Off].
3. Tap [×] on the title bar to finish and close the menu.

15.12 How to Register an AIS or DSC Target to the Buddies List

The buddies list provides a quick reference to ships' MMSI and nickname. For example, you might want to enter the MMSI and nickname of partner ships or ships that often operate in your area.

How to add a buddy to the buddies list

1. Home page→[Settings]→[Targets]→[Buddies List (AIS & DSC)]. The window shown below appears.



2. Tap [Add Buddy] to open the numeric software keyboard.
3. Enter the MMSI number of your buddy, then tap [✓].
4. Tap the MMSI number entered in step 3 to show the software keyboard.
5. Enter the nickname of your buddy, then tap [✓].



6. Tap [×] on the title bar to finish and close the menu.

How to delete an entry from the buddies list

1. Home page→[Settings]→[Targets].
2. Tap [Buddies List (AIS & DSC)].
3. Tap the red "X" corresponding to the buddy to delete.

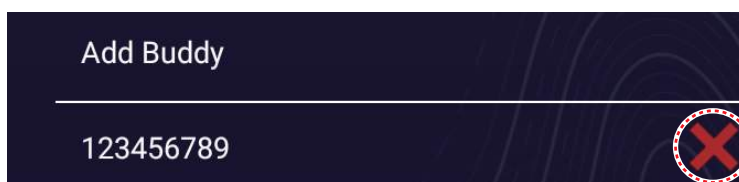

← Tap to delete buddy from list.

4. You are asked if you are sure to delete the buddy. Tap [OK].
5. Tap [×] on the title bar to finish and close the menu.

15.13 CPA Graphic Display

The CPA graphic display, which requires own position and heading data, draws a line between own ship position and the selected AIS target to help you monitor an AIS target's heading and speed changes. The display is useful as an anti-collision aid, especially in congested waters.

To activate or deactivate the CPA graphic display, open the [Targets] menu, then turn on [CPA Graphic Display].

To find the CPA of an AIS target on the radar or chart plotter display, tap the AIS target. The CPA line connects with the position of your vessel and the CPA of the AIS target, and its color is the same as the color of the AIS target's symbol. The example below shows the appearance of the graphic display on the chart plotter display.

If the CPA/TCPA alarm is generated while the CPA line is in use, the CPA line and the selected target's symbol turn red.

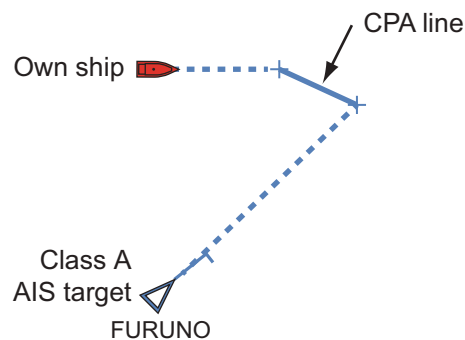

The CPA graphic display is deactivated (erased) in the following conditions:

- The CPA line is turned off. The line can be turned off by tapping the CPA line (or vessel icon* or target) to show the Pop-up menu, then select [CPA].
* Chart plotter display only
- The CPA line feature is deactivated.
- The CPA/TCPA of the selected target will be a negative value.
- The signal from the selected target can no longer be received (lost target).
- The speed and heading signals for the selected target are lost.
- Own ship's speed/heading signal is lost.

15.14 AIS Transponder FA-30, FA-50

The FURUNO AIS Transponder FA-30 (or FA-50) installs in the TZT9E/13E or TZ-MAP9/13 network and can be controlled from the multi function display. To access the menu for the transponder, do as shown below. See the respective operator's manual for details.

1. Connect the FA-30 (or FA-50) to the TZT9E/13E or TZMAP9/13 network.
2. Home page→[Settings]→[Initial Setup]→[Network Sensor Setup]→[FA30 Browser] or [FA50 Browser].

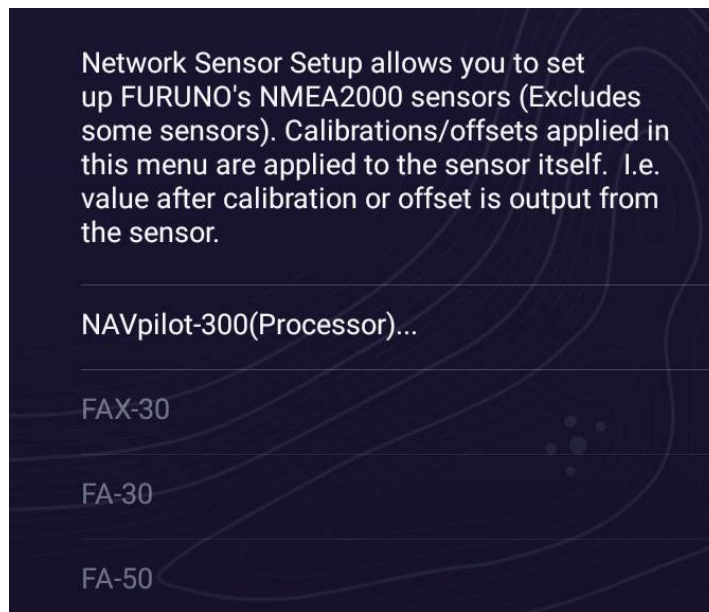

↓ [Tap FA-30] or [FA-50].

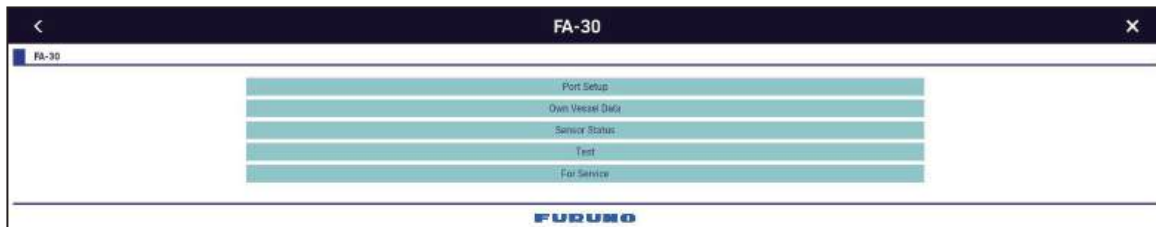

OR

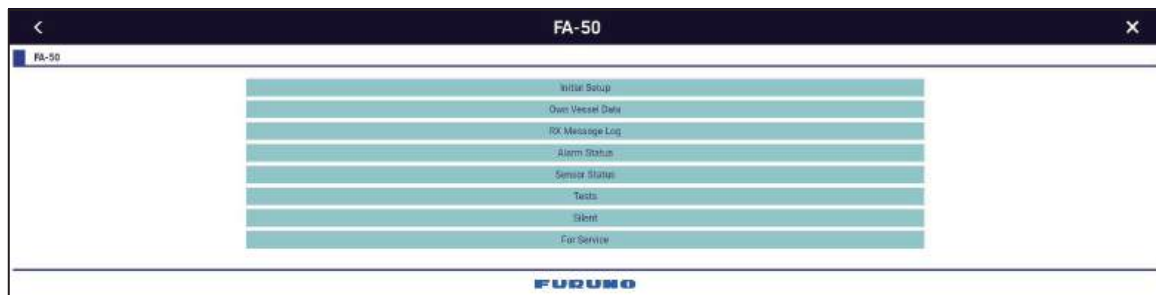

3. See the Operator's Manual for the FA-30 (FA-50) for operating procedures.

15.15 DSC Message Information

The DSC (Digital Selective Calling) message information feature provides, on the chart plotter and radar displays, the MMSI no. and position* of the ships that have transmitted a DSC message to you. A hexagon-shaped marker marks the position of the ship at the time the DSC was transmitted to you. The marker is color-coded according to the type of DSC message sent, red for distress and green for non-distress.

* Position at the time of DSC message transmission. Position information is not updated.

Red: DSC marker for a distress message

Green: DSC marker for a non-distress message

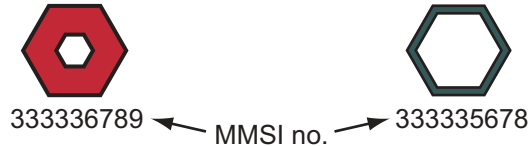

Note: This feature requires connection of a DSC capable radiotelephone that outputs the DSC sentence in NMEA 2000 format.

15.15.1 DSC distress message

When a DSC distress message is received, the message "DSC Distress Call received" appears flashing in the Status bar. To delete the distress message, tap the Status bar.

15.15.2 How to set a DSC marker as destination

Tap the DSC marker, then tap [Goto] on the Pop-up menu.

15.15.3 How to display DSC marker information

Tap a DSC marker to display the basic information (position, MMSI no. of the ship that transmitted a DSC message, etc.). To get detailed information, tap a DSC marker, then tap [Info] on the Pop-up menu.

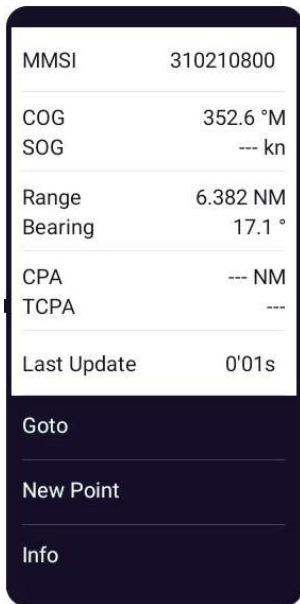

Simple information



Detailed information

15.15.4 The DSC list

When a DSC message is received, it is automatically saved to the [DSC] list. On the screen, the MMSI number can be changed to a specified character string, such as the name of the ship, in order to quickly identify which ship sent you a message.

How to display the DSC list

Home page→[Lists]→[DSC]. The vertical mark to the left of each message denotes DSC message type.

Red: distress

Green: non-distress.

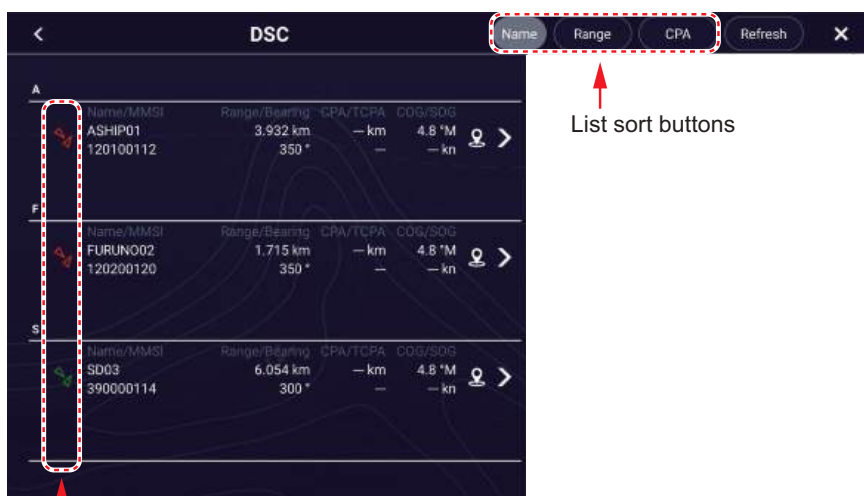

List sort buttons

Vertical bar

The title bar has these buttons for sorting the list.

[Name]: DSC targets sorted in alphanumeric order.

[Range]: DSC targets sorted by range in ascending order.

[CPA]: DSC targets sorted by CPA in ascending order.

Note: To update the list, tap [Refresh].

How to show detailed information about a DSC marker

Tap the target on the [DSC] list to show its detailed information.



Note 1: To display the specified DSC mark in the center of the chart plotter display, tap [Find on Chart] at the bottom.

Note 2: The DSC nickname can also be edited like that for the AIS. Tap the DSC whose nickname you want to edit on the DSC list. Tap [Nickname] to edit the nickname. (See "How to edit an AIS nickname" on page 15-6 for details.)

This page is intentionally left blank.

16. OTHER FUNCTIONS

Once you have become acquainted with your equipment, you can set it according to your needs. You can change system configuration, change how the equipment operates and displays information, etc.

16.1 General Menu

This section describes the [General] menu items not described in other chapters. To open the [General] menu, Home page→[Settings]→[General].

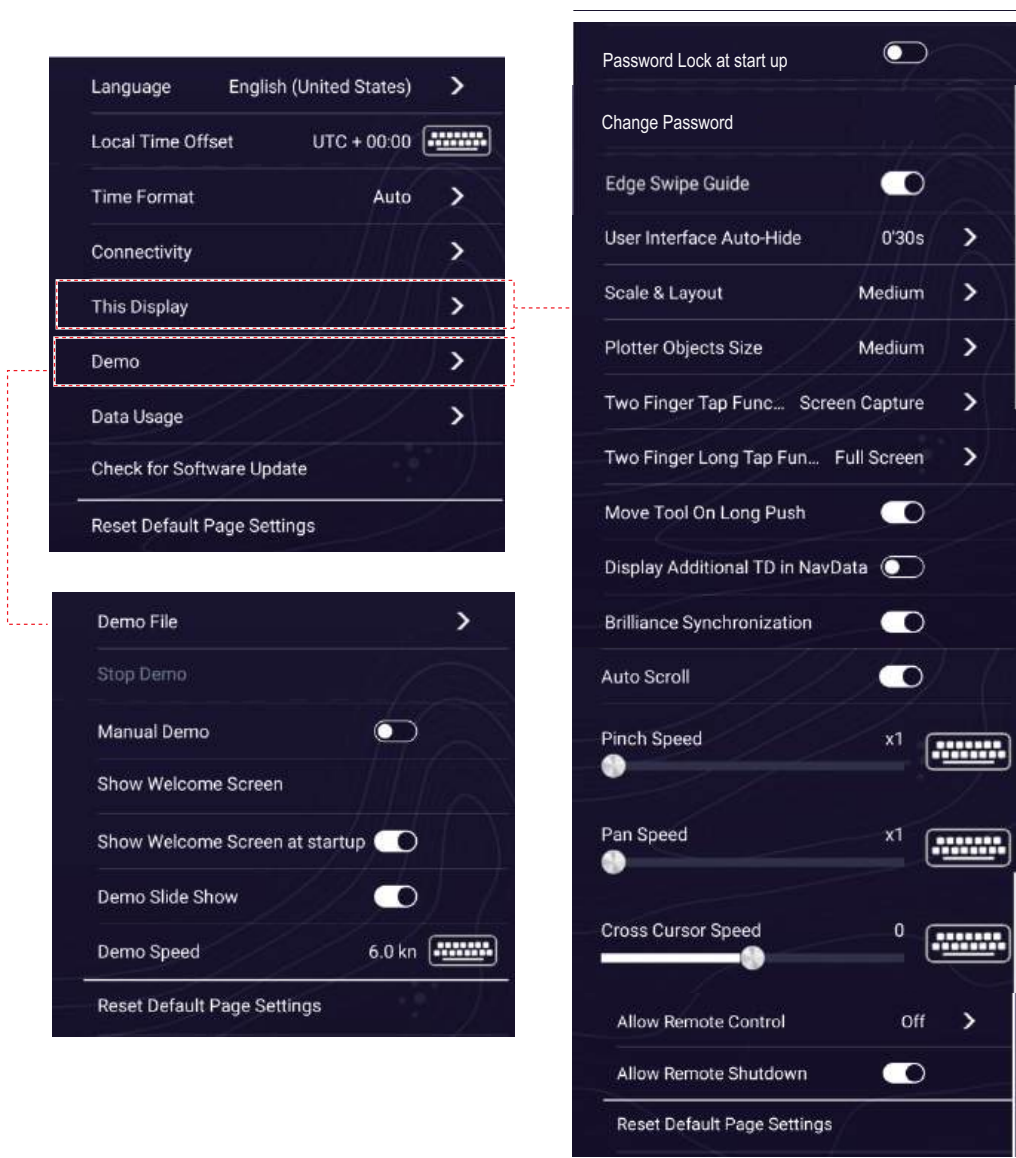

Menu item	Function	Options
[Local Time Offset]	Select the time difference between local time and UTC time.	UTC -12:00 to UTC +13:00 (at 15 minute intervals)
[Time Format]	Select how to display time, in 12 or 24 hour format. [Auto] automatically inserts AM, PM indication in 24 hour clock, when the language is English.	[Auto], [24 Hours], [12 Hours]

16. OTHER FUNCTIONS

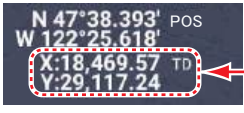
Menu item	Function	Options
[Edge Swipe Guide]	In the On setting, the edge swipe indicator shown below appears for about 15 seconds at the top, bottom, left or right edge of the screen when you change the display screen, or close a menu or list. This means that a function is available by swiping the edge swipe indicator (see section 1.8). The indicator disappears when you operate the screen. 	Off, On
[User Interface Auto-Hide]	Select the timeout for the following items and the [FURUNO] icon on the instrument screen (full screen). <ul style="list-style-type: none"> • Layers menu • Slide-out menu • Pop-up menu • Quick page Note: The [FURUNO] icon always appears on the split screen instrument display and other displays.	[0'03s], [0'05s], [0'10s], [0'15s], [0'30s], [Never]* *: Not automatically hidden.
[Plotter Objects Size]	The size of the symbol and accompanying text of items not directly related to the chart (points, routes, AIS targets, etc.) can be changed.	[Small], [Medium], [Large], [Extra Large], [Double Extra Large]
[Move Tool On Long Push]	Enable the "move" function with long-push of an object. Applicable to these functions: <ul style="list-style-type: none"> • Points/event mark icons, including log catches. (excluding icons on the Fish Finder display) • Route waypoints • Boundary points • Guard zone • EBL/VRM 	Off, On
[Display Additional TD in NavData]	In the "On" setting, the TD information is added to the own ship's position in the Data window.  Loran TD (time difference)	Off, On
[Auto Scroll]	In the "On" setting, the chart is appropriately and automatically scrolled when the cursor goes out of the display area.	Off, On
[Pinch Speed]	Set the speed to pinch the screen with two fingers for zooming in/out.	×1.0 to ×3.0
[Pan Speed]	Set the pan speed to drag the screen with one finger.	×1.0 to ×3.0
[Cross Cursor Speed]	Adjust the cross cursor speed.	-7 to +7
[Reset Default Page Settings]	Reset the [This Display] menu settings to default.	—
[Demo File]	Select the data (internal or external) to use for demo mode. When using external data, connect the recording medium containing the demo data to the USB port. Note: This menu is for use by dealers. Users should not use this menu. Improper setting may cause lost of user settings.	—
[Stop Demo]	Stop the demo mode selected at [Demo File].	—

Menu item	Function	Options
[Manual Demo]*	To use the demo mode with the data selected in [Demo File] above, turn [Manual Demo] off. The own ship moves based on that data. To use the demo mode without the demo file, set to On. Your vessel moves according to the speed set in [Demo Speed].	Off, On
[Show Welcome screen]	Show the welcome screen.	—
[Show Welcome Screen at startup]	When turned on, the welcome screen appears at startup.	Off, On
[Demo Slide Show]	No use.	Off, On
[Demo Speed]	Set the ship's speed to use in the demo mode, when [Manual Demo] is turned on.	0 to 50 kn
[Reset Default Page Settings]	Reset the [Demo Mode] menu settings to default.	—
[Check for Software Update]	Checks if your software is up-to-date. See section 16.5.	—
[Reset Default Page Settings]	Reset the [General] menu settings to default.	—

*: In the demo mode, you can move the own ship icon to the tapped position on the chart plotter display. Tap at the desired location and tap [Move Boat] from the Pop-up menu.

16.2 Units Menu

The [Units] menu sets the unit of measurement for speed, distance, depth, etc. To open the [Units] menu, Home page→[Settings]→[Units].

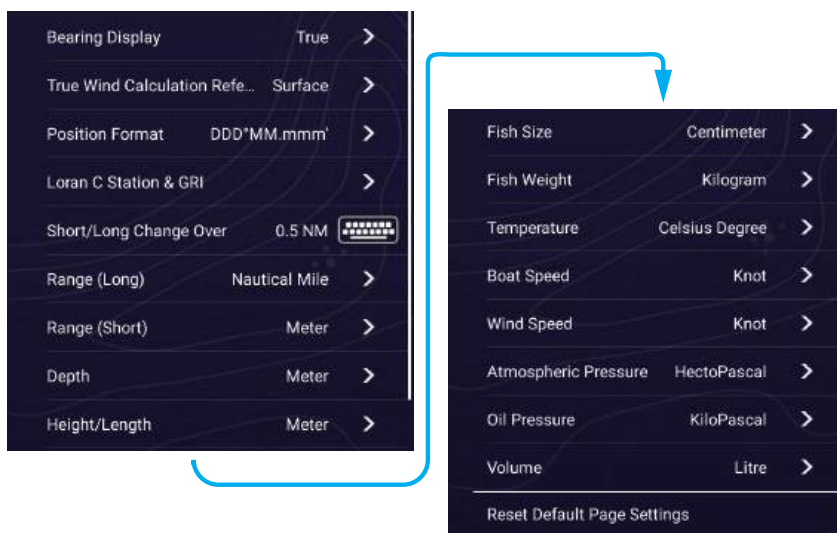

Menu item	Function	Options
[Bearing Display]	The mode (magnetic or true) of all heading and bearing data.	[Magnetic], [True]

16. OTHER FUNCTIONS

Menu item	Function	Options
[True Wind Calculation Reference]	Select wind value to display from speed over ground or speed through water (surface).	[Ground], [Surface]
[Position Format]	Select position format.	[DDD°MM.mmmm'], [DDD°MM.mmm'], [DDD°MM.mm'], [DDD°MM'SS.ss"], [DDD.dddddd°], [Loran-C], [MGRS].
[Loran C Station &GRI]	Enter Loran C Station and GRI. Available when [Position Format] is selected to [Loran-C].	—
[Short/Long Change Over]	Set the distance at which to switch between short and long range (setting range: 0.0 to 2.0 NM). If the setting is 0.5, for example, short range is automatically selected when the long range unit is 0.4 or less. The setting "0.0" fixes the unit to long range.	—
[Range (Long)]	Select the unit for the long range.	[Nautical Mile], [Kilometer], [Mile]
[Range (Short)]	Select the unit for the short range.	[Foot], [Meter], [Yard]
[Depth]	Select the unit for the depth.	[Foot], [Meter], [Fathom], [Passi Braza]
[Height/Length]	Select the unit for the height and length.	[Foot], [Meter]
[Fish Size]	Select the unit for the fish size.	[Inch], [Centimeter]
[Fish Weight]	Select the unit for the fish weight.	[Pound], [Kilogram]
[Temperature]	Select the unit for the temperature.	[Fahrenheit Degree], [Celsius Degree]
[Boat Speed]	Select the unit for the boat speed.	[Knot], [Kilometer per Hour], [Mile per Hour], [Meter per Second]
[Wind Speed]	Select the unit for the wind speed.	[Knot], [Kilometer per Hour], [Mile per Hour], [Meter per Second]
[Atmospheric Pressure]	Select the unit for the atmospheric pressure.	[HectoPascal], [Millibar], [Millimeter of Mercury], [Inch of Mercury]
[Oil Pressure]	Select the unit for the oil pressure.	[KiloPascal], [Bar], [Pound per Square Inch]
[Volume]	Select the unit for the volume.	[Gallon] (Gallon & Gallon/Hour), [Litre] (Litre & Litre/Hour)
[Reset Default Page Settings]	Reset the [Units] menu settings to default.	—

16.3 Initial Setup Menu

The [Initial Setup] menu, which is mainly for use by the installer of the equipment, sets up the system according to the sensors connected. These adjustments require some knowledge of marine electronics equipment. If you are unsure of your abilities, have a qualified marine electronics technician make the adjustments. Inadequate adjustment can affect performance.

To open the [Initial Setup] menu, →Home page→[Settings]→[Initial Setup], For the [Fusion] menu items, see section 12.3.

[Boat Information] menu

Menu item	Description	Options (setting range)
[Boat Height]	Set the height of your boat.	0 to 999 m
[Boat Width]	Set the width of your boat.	0 to 99 m
[Boat Length]	Set the length of your boat.	0 to 999 m
[Boat MMSI]	Set the MMSI of your boat.	Maximum of nine characters
[Boat Name]	Set the name of your boat.	Maximum of 32 characters
[Size of Own Ship Icon]	Set the size of own ship icon.	50 to 150
[Depth Display]	Select the start point for depth measurement.	[Under Keel], [Under Sea Level]
[External Transducer Draft]	When using a depth sensor other than a transducer on the network or a transducer connected to a multi beam sonar as the depth data source, set the transducer draft. When using a transducer on the network or a transducer connected to a multi beam sonar as a depth data source, configure the settings below. Transducer connected on network: Home page→[Settings]→[Fish Finder]→[Fish Finder Initial Setup]→[Transducer Draft]. Multi beam sonar, Home page→[Settings]→[DFE-3D Multi Beam Sonar]→[Initial Setup]→[Transducer Draft].	0.0 to 99.9 m
[Keel Draft]	Set the keel draft.	0.0 to 99.9 m
[Engine Count]*	Number of engines.	0 to 6
[Reset Default 'Page Settings]	Reset the [Boat Information] menu settings to default.	—

*: The number of engines specified here is reflected on the outboard display of the instrument display.

16. OTHER FUNCTIONS

[Instruments Setup] menu



The [Instruments Setup] menu has three sub menus.

Menu item	Description
[Engine & Tank Automatic Setup]	
The system automatically detects active engines and tanks connected to the same network.	
[Engine & Tank Manual Setup]	
[Nickname]	Change the nickname for the engine or tank
[Used For Propulsion]	Select which engine/tank is used to calculate the distance which may be traveled using the remaining fuel. On uses the engine/tank for calculations, Off ignores the engine/tank.
[Reset]	Resets the engine/tank details to default.
[Graphic Instruments Setup]	
[Maximum Boat Speed]	Set the transducer's maximum detectable speed.
[Maximum Wind Speed]	Set the transducer's maximum detectable speed.
[Minimum Depth]	Set the transducer's minimum detectable depth.
[Maximum Depth]	Set the transducer's maximum detectable depth.
[Minimum Sea Surface Temperature]	Set the transducer's minimum detectable temperature.
[Maximum Sea Surface Temperature]	Set the transducer's maximum detectable temperature.
[Max. RPM]	Set the maximum rpm of your engine to show on the RPM display.
[Red Zone Oil Pressure]	Set the starting value for the red zone area of the oil pressure meter.
[Max. Oil Pressure]	Set the maximum oil pressure for your engine.
[Min. Temperature]	Set the minimum temperature for your engine.
[Red Zone Temperature]	Set the starting value for the red zone area of the engine temperature indicator.
[Add Default CZone Pages]	Create, edit C-Zone pages.
[CZone DIP Switch Settings]	Set this unit's DIP switches. For the service technician. Do not change the settings.
[Reset Instrument Pages]	Reset all instrument pages.
[Reset Default Page Settings]	Resets the [Graphic Instruments Setup] menu settings to default.

[Manual Fuel Management] menu

Menu item	Description	Options (setting range)
[Total Fuel Capacity]	Enter the total fuel capacity of your tank(s).	0 to 9,999 L
[Manual Fuel Management]	Turn on for manual fuel management.	Off, On
[Reset Default Page Settings]	Reset the [Manual Fuel Management] menu settings to default.	

[Data Sensors] menu

Menu Item	Description	Options (setting range)
[Data Source]	Select the source for each data to input to the system. If two or more sources are connected for a data, select one using the pull-down dialog box. (FURUNO sensors are shown at the upper part of the list.)	
[Sensor List]	Show the information for sensors (network/CAN/LAN/USB and Bluetooth sensors) connected to your equipment. Tap the sensor to show the detailed information. You can edit the items with  icons on the right side of the screen, or you can disconnect the device by tapping [Permission to use]. The password input is required for prohibiting or allowing the device (after once prohibited). The devices that have no permission are indicated with the forbidden icon () on the left side of the screen. Note: If you change each instance value, you need to restart its sensor.	
[NMEA 0183 Output]	[PORT CONFIGURATION]: <ul style="list-style-type: none"> • [Baudrate]: Select the baudrate. • [NMEA-0183 Version]: Select the version for NMEA 0183. 	<ul style="list-style-type: none"> • [4,800], [9,600], [38,400] • [1.5], [2.0], [3.0]
	[SENTENCES]: Turn on the NMEA sentences to output. Note 1: When the TTM sentence is output together with another sentence at the same time, the number of TTM targets output may be reduced due to the communication bandwidth restrictions. Note 2: The TTM sentence is not output when a radar connected to a TZX9E/13E unit on the network has the full auto tracking feature turned on.	Off, On
[NMEA 2000 PGN Output]	Turn on for the PGNs (Parameter Group Number, CAN bus (NMEA 2000) message) to output from the CAN bus port. Note: Some PGNs are set at the factory to "On".	Off, On
[Sky View...]	Show the condition of GPS and GEO (WAAS) satellites on the [GPS SkyView] display. The bearing and elevation angle of all GPS and GEO satellites (if applicable) in view of your receiver appear. For the service technician. Note: The [GPS SkyView] display can also be shown by tapping the GPS icon (shown right) on the Home page.	
[GP330B WAAS Mode]	Turn on to use the WAAS mode for the corresponding GPS antenna.	Off: Deactivate
[WS200 WAAS Mode]		On: Activate

[Network Sensor Setup] section

Menu item	Description
[FAX-30 Browser]	Show the Facsimile Receiver FAX-30 display.
[FA-30 Browser]	Show the AIS Receiver FA-30 display.
[FA-50 Browser]	Show the AIS Receiver FA-50 display.

[SC-30]

Menu item	Description	Options
[WAAS Mode]	Turn on to use the WAAS mode.	Off, On
[Heading Offset]	Enter the offset value for heading.	-180 to +180°
[Pitch Offset]	Enter the offset value for pitching.	-90 to +90°
[Roll Offset]	Enter the offset value for rolling.	-90 to +90°

[Data Offset] menu

Menu item	Description	Options (setting range)
[Heading]	Offset heading data.	-180.0 to +180.0°
[Speed Through Water]	Calibrate speed data. Enter amount in percentage.	-50 to +50%
[Wind Speed]	Offset wind speed data. Enter amount in percentage.	-50 to +50%
[Wind Angle]	Offset wind angle data.	-180.0 to +180.0°
[Sea Surface Temperature]	Offset sea surface temperature data.	-10 to +10°C
[Reset Default Page Settings]	Reset the [Data Offset] menu settings to default.	

[GPS Position] menu

Menu item	Description	Options (setting range)
[Longitudinal (from bow)]	Enter the GPS antenna positioning bow-stern (Longitudinal) and port-starboard (Lateral) position from the origin. 	0 to 999 m
[Lateral (-Port)]		-99 to +99 m
[Reset Default Page Settings]	Reset the [GPS Position] menu settings to default.	

[Data Damping] menu

Menu item	Description	Options (setting range)
[COG & SOG]	Set data damping time. The lower the setting the faster the response to change.	0 to 59 seconds
[Heading]		
[Speed Through Water]		
[Wind Speed & Angle]		
[Rate of Turn]		
[Reset Default Page Settings]	Reset the [Data Damping] menu settings to default.	

[IF-NMEAII Setup] menu

Menu item	Description	Options (setting range)
[Select IF]	Select [IF-NMEAII] to set the analog data that is input from the IF-NMEAII. These settings are reflected after restarting the IF-NMEAII.	

Menu item	Description	Options (setting range)
[Category]	Select the category for the analog sensor to set.	[Wind], [ST800_850], [Fuel], [Fresh Water], [Waste Water], [Live Well], [Oil], [Black Water]
[Resistance Full]	The resistance, in Ohms, when the tank is full.	0 to 300 Ohm
[Resistance Mid]	The resistance, in Ohms, when the tank is half full.	0 to 300 Ohm
[Resistance Empty]	The resistance, in Ohms, when the tank is empty.	0 to 300 Ohm
[Capacity]	The capacity of the tank.	0 to 2650 G
[Fluid Instance]	Set tank NMEA 2000 instance number.	0 to 5
[Self test]	Test results are displayed.	
[Set Hardware To Factory Default]	Resets the converter selected at [Select IF] to factory default.	
[Reset Default Page Settings]	Reset the [IF-NMEA2000 Setup] menu settings to default.	

[Fusion] menu

Menu item	Description	Options (setting range)
[Connect to Fusion]	Connect to your Fusion equipment.	
[Fusion Auto Volume]	Turn on to allow this unit to control the Fusion volume automatically.	Off, On
[Minimum Speed]	Set the minimum speed threshold. Exceeding this speed activates volume auto control.	0 to 99 kn
[Maximum Speed]	Set the maximum speed threshold.	0 to 99 kn
[Volume Increase]	Set the amount of extra volume to output.	10 to 50%
[Reset Default Page Settings]	Reset the [Fusion] menu settings to default.	

[Service / Self Test / Log] menu

Menu item	Description	Option (setting range)
[Synchronization Log]	Synchronization log for this unit within the network.	
[Enable NMEA 2000 Log]	Turn on to storage the NMEA 2000 data.	Off, On
[NMEA 2000 Log Storage Location]	Select where to storage the data.	
[Quick Self Test]	Information for this equipment and connected sensors.	
[Certification Mark]	Show the certification marks this equipment has received.	
[Service]	For the service technician.	
[Reset Default Page Settings]	Reset the [Service / Self Test / Log] menu settings to default.	

[Home Page] menu

Menu item	Description
[Factory Reset]	Reset the home page configuration to default.

Others menu items

Menu item	Description	Option (setting range)
[Chart Master Device]	Turn on to set this equipment as the chart master, or off to set as secondary.	Off, On
[System ID]	The system ID for this device within the network.	
[Update Network Equipments]	Updates all NavNet equipment in the network. For the service technician.	
[Remote Controller Configuration]	If you have multiple TZT9E/13Es connected in the same network, select the display to operate with MCU-005, MCU-006/MCU-006H. Also, set the ranking of the display to be switched among the selected displays. Multiple TZMAP9/13s cannot be connected in the same network.	
[Sirius Radio Diagnostic]	Check the satellite radio of the FURUNO BBWX weather receiver for proper operation. See section 14.9.3.	
[Sirius Weather Diagnostic]	Check the weather section of the FURUNO BBWX weather receiver for proper operation. See section 14.8.	
[Reset Default Page Settings]	Reset the [Initial Setup] menu settings to default.	

16.4 Facsimile Receiver FAX-30

The FURUNO Facsimile Receiver FAX-30 installs in the TZMAP9/13 or TZT9E/13E network and can be controlled from a TZMAP9/13 or TZT9E/13E display. Below are the steps to start fax operation.

1. Connect the FAX-30 to the TZMAP9/13 or TZT9E/13E network.
2. Home page→[FAX-30].



3. Tap [WX FAX] or [NAVTEX].

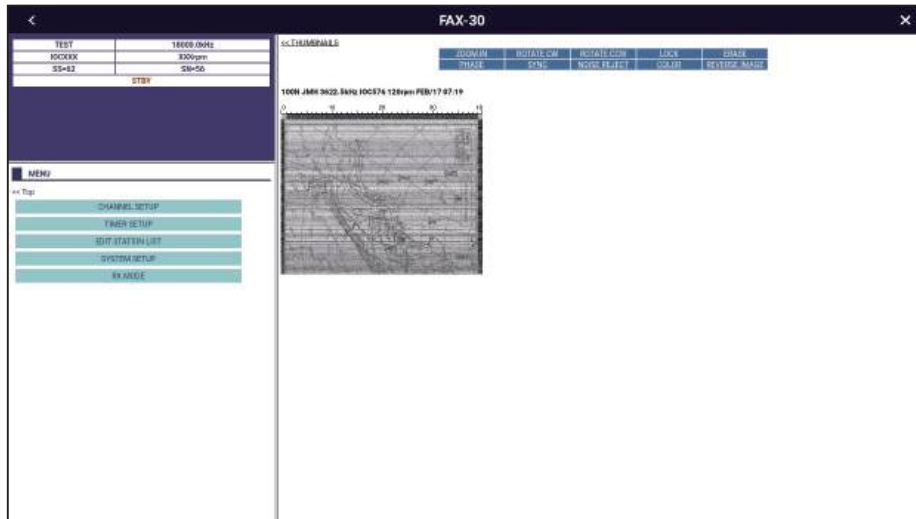

4. Refer to the Operator's Manual of the FAX-30 for operation information.

The FAX-30 display can only be accessed by one TZMAP9/13 or TZT9E/13E unit at a time. When another display (for TZT9E/13E only, multiple TZMAP9/13 displays cannot be connected) accesses the FAX-30, control of the FAX-30 is given to that display after the picture has stopped completely. This sequence takes approximately one minute.

16.5 How to Check, Update the Software

You can check whether your software is up to date via the Internet. You can update the software.

1. Connect to the internet, referring to section 1.20.
2. Home page→[Settings]→[General]→[Check for Software Update].

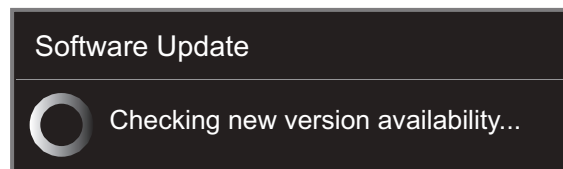

- After the window shown at right appears, one of the following messages is displayed depending on the software version of this unit.
- **If the software is up to date**, the message "The latest software is installed on this device" appears. Go to step 3.
 - **If the software on this device is outdated**, the message "NEW SOFTWARE AVAILABLE: VERSION XX.XX DO YOU WANT TO UPGRADE?" appears. Refer to Method 1 under "How to update the software."
3. Tap [OK] to erase the message.
 4. Tap [x] on the title bar to finish and close the menu.

How to update the software

Note: Do the update while berthed. The display unit cannot be used while the software is being updated.

There are two methods available to update the software:

- Use a wireless LAN to update the software.

- Download the software to a USB flash memory.

Method 1: Update via wireless LAN

Note 1: Do not turn off the multi function display while updating the software.

Note 2: If multiple MFDs are connected in the same network, the software of all MFDs is updated. Be sure that all MFDs are powered before updating.

Note 3: To reduce the size of the software update file to be downloaded, only the OS, applications, FPGA, and e-guide are updated. If you need to update the tide database, HTML access file, etc., follow the procedure on page 16-13.

Note 4: For details about the update file, access <https://v1.furunosoftware.com/download.html>, then select [Software History].

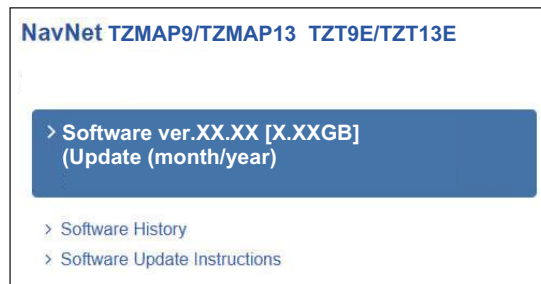

1. Connect to the internet, referring to section 1.20. The message at the top of the window asks if you want to perform the upgrade. (XX.XX is the version number.)
 - **[UPGRADE NOW]:** Installs the latest version.
 - **[REMIND ME LATER]:** Be reminded later. The window closes.
 - **[SKIP THIS VERSION]:** Skip the software update. In this case, there is no automatic check of software version at next internet connection or startup.

Note 1: If you are connected to Wi-Fi at startup, after tapping [OK] on the message in the caution window (see section 1.3), the above message appears if the software can be updated.

Note 2: Even after selecting [REMIND ME LATER] or [SKIP THIS VERSION], the above message is still displayed when you select [Settings]→[General]→[Check for Software Update].

2. Tap [UPGRADE NOW]. The [Software Update] window appears.
3. The [SOFTWARE TERMS AND CONDITIONS] window appears. Read the contents and then tap [AGREE]. The software download begins. The download progress appears at the bottom of the screen, and the NavNet web page appears in the center of the screen. After the download is complete, the software update (about 10 minutes) begins. Messages and update screens appear during the update, but no action is required as the process is fully automatic. When the update is complete, the unit automatically restarts three times and then the welcome screen (see section 1.3) appears.

Note: If the equipment is set to not show the welcome screen at startup ([Settings]→[General]→[Demo]→[Demo Mode]→[Show Welcome Screen at startup]), the screen that was displayed before the update is shown.
4. Check whether the equipment was updated. Home page→[Settings]→[Initial Setup]→[Service / Self Test / Log]→[Quick Self Test]→check if [App Version] is updated.

Method 2: Update using update file saved to USB flash memory

Note 1: Use a USB flash memory having a capacity of 4 GB or more. Format the flash memory in advance, in file system FAT or FAT32.

Note 2: Remove all USB devices from the multi function display before updating the software.

Note 3: Do not remove the USB flash memory while updating the software, to prevent data loss.

Note 4: If multiple multi function displays are connected on the same network, turn off the power of all other multi function displays and update them one at a time.

1. Access <https://v1.furunsoftware.com/download.html> from a PC.

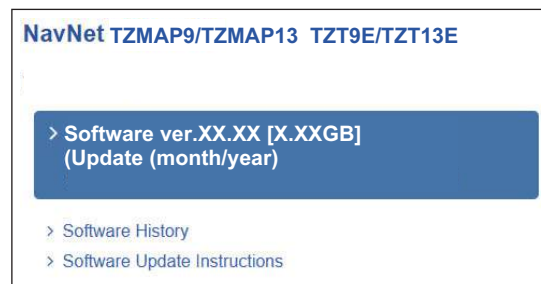

2. Download the latest software to the PC, then unzip the software files.
3. Insert a USB flash memory in the PC, then copy the following items to the flash memory.

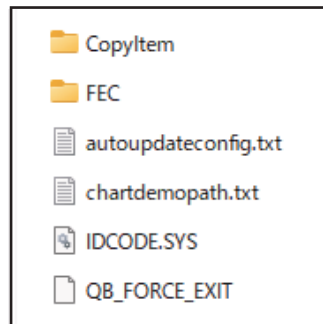

Note: Copy only the specified items to the USB flash memory. Do not copy other items to the flash memory.

4. Remove the USB flash memory from the PC.
5. Turn off the power to this unit, then insert the USB flash memory containing the software into USB port located at the left side of the unit.
6. Turn on this unit.
The software update (about 10 minutes) begins. Messages and update screens appear during the update, however no action is required as the process is fully automatic.
7. After the updating is completed, the following message appears.

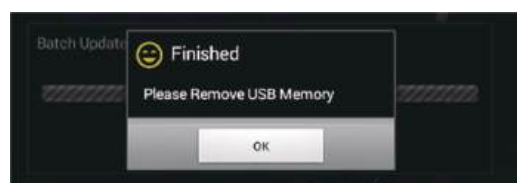

8. Remove the USB flash memory. The unit automatically restarts three times and then the welcome screen (see section 1.3) appears.
Note: If the equipment is set to not show the welcome screen at startup ([Settings]→[General]→[Demo]→[Demo Mode]→[Show Welcome Screen at startup]), the screen that was displayed before the update is shown.
9. Check whether the equipment was updated. From the home screen, [Settings]→[Initial Setup]→[Service / Self Test / Log]→[Quick Self Test]→check if [App Version] is updated.

16.6 How to Manage Your Charts

A TZ MAPS world chart is provided standard. For all other TZ MAPS charts you will need to purchase and load a chart license (for MM3D paid charts an unlock code is necessary). To share the system ID and unlock code between NavNet TZtouch series units connected within the same network, go the Home page on any unit→[Settings]→[Initial Setup]→turn on [Chart Master].

Note: If two or more NavNet TZtouch series devices share an unlock code or license, it is necessary to obtain a new unlock code when changing the Chart Master settings. For example, one unit is set as "main" (Chart master setting: On) and the other unit as "secondary" (Chart master setting: Off), you need to reacquire an unlock code. For information on how to re-obtain the unlock code, see "Chart is not displayed after changing chart master settings" on page 17-3.

16.6.1 How to update or add TZ MAPS charts

By connecting this device to the Internet and logging into My TIMEZERO™, you can purchase and renew a TZ MAPS chart license (valid for one year) and download chart data online. Downloaded chart data can be used even when offline by putting it on a microSD card and inserting it into the card slot on the back of the device.

Note: Chart licenses are valid for one year, and during this period charts can be downloaded and updated. After the license period expires, you can continue to display the already downloaded charts. However, charts cannot be downloaded or updated. Also, functions that require license cannot be used. After the one-year period you can purchase a new chart license, which will be automatically renewed on a yearly basis. To cancel the automatic renewal (from your My TIMEZERO™ account, see the link below), be sure to cancel before the one-year validation period expires. The automatic renewal cannot be canceled on the device side.

<https://extranet.mytimezero.com/>

1. Home page→[Charts]→[TZ MAPS Store].

Tap here to highlight the selected area, on the right side of the screen.
 (White background: Not purchased, Blue background: Purchased)

[Buy]: Not purchased, [✓]: Purchased

*: When the license expires (one year), the indication changes to [Subscribe], and when you select and purchase a subscription, the indication changes to [Subscribed].

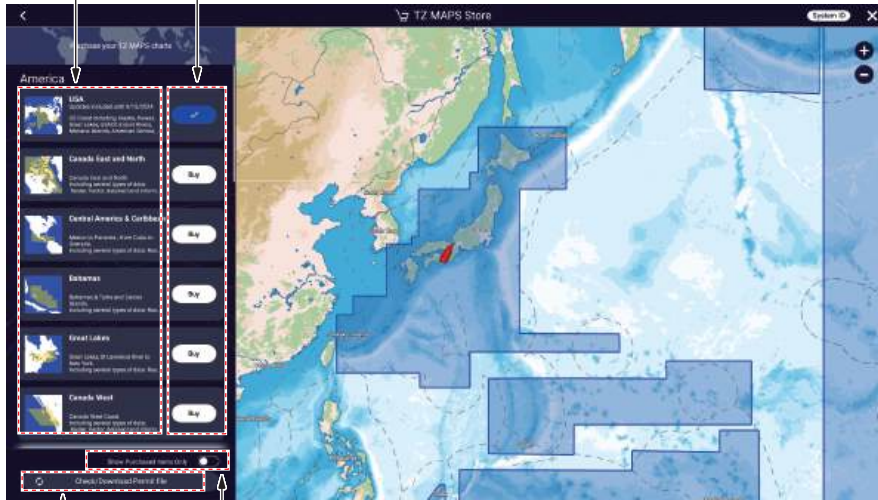

Turn ON to display only purchased charts.

Tap to check whether there is a license for the purchased chart. If there is, the file will be downloaded. After downloading, the [Buy] button of the purchased chart changes to a blue ✓ button, and you can then download the chart data for the purchased area,

2. Tap the [Buy] button corresponding to the area to purchase. The message "Please wait, preparing your purchase" appears, then the "buy screen" appears

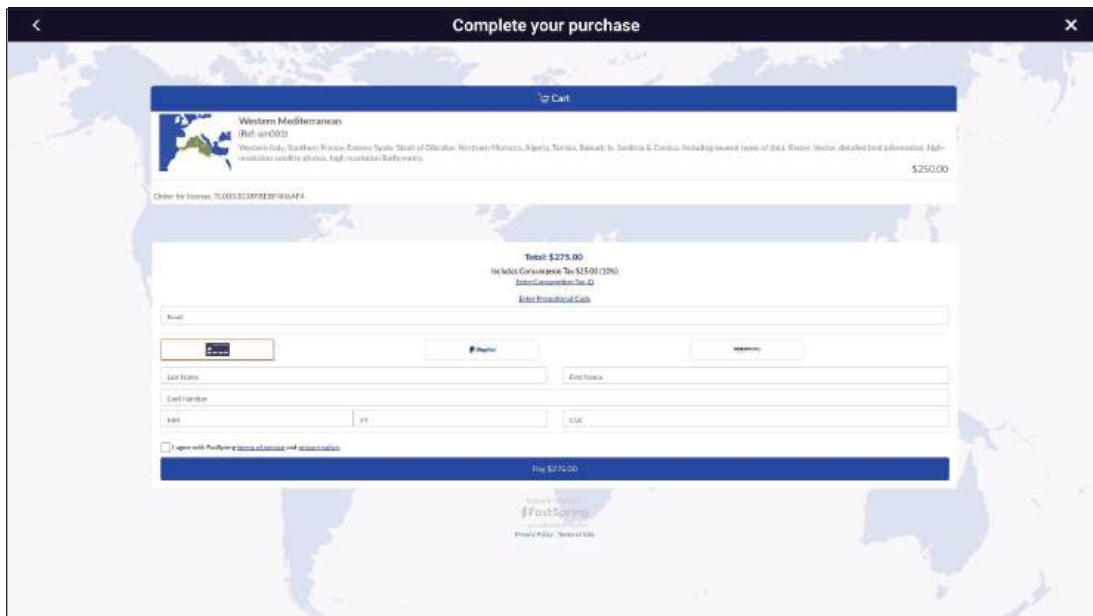

16. OTHER FUNCTIONS

If you are not connected to the Internet, a quick response code appears. Use your smartphone/tablet to read it and display the “buy screen”.

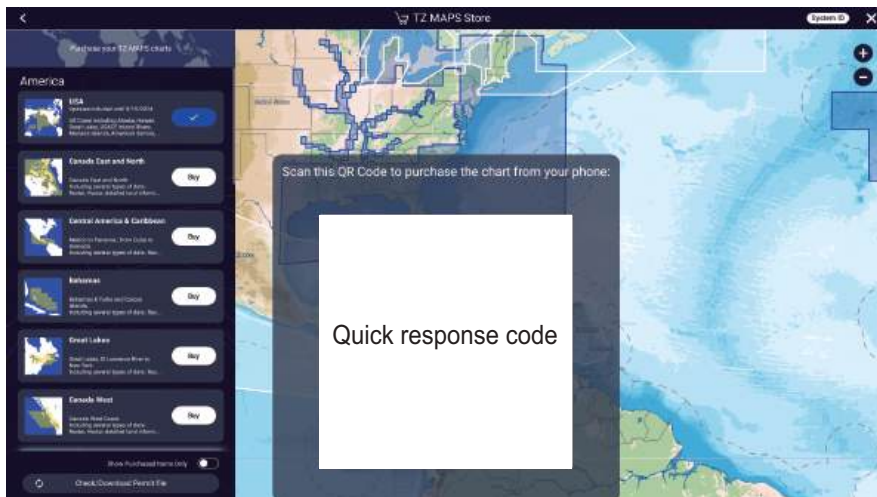

3. Select how to buy the chart,
4. Enter the requested information.
5. Read the conditions of purchase, check ✓ to agree, then tap [Payment],
6. If you purchased a license using a quick response code, a ZUC file is sent to your registered email address. Save the file to a USB flash memory, insert the memory into the USB port of this equipment, and load the file.

16.6.2 How to update TZ MAPS charts

If there is a new version of a downloaded chart data, there are two ways to update the chart, individually or all at once.

1. Home page→[Charts]→[TZ MAPS Update],

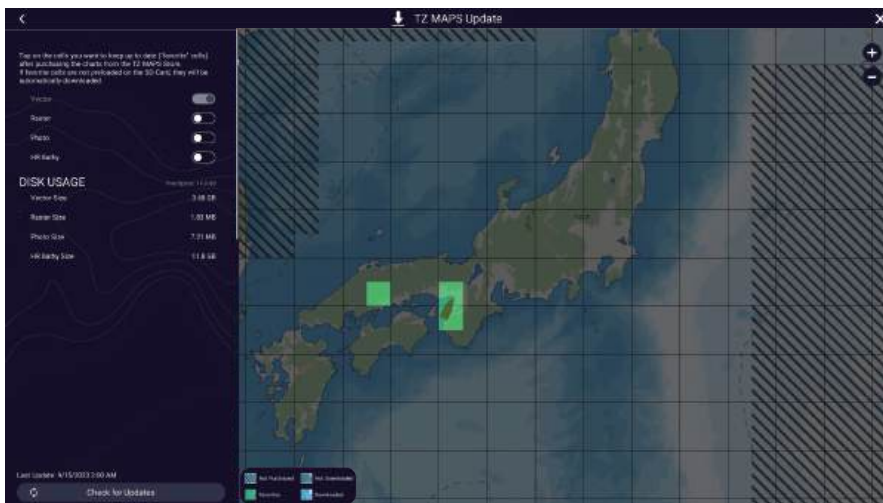

2. **Update chart data individually:** Tap the area you want to update.
Update chart data collectively: Tap [Check for Updates], at the bottom left corner of the screen. A “↓” icon appears in those areas that have [Favorites] status and can be updated. You can update multiple areas. Tap [Download Updates] at the bottom left corner of the screen. The download begins and progress is indicated at the bottom left corner of the screen. The [Download Updates] button label changes to [Cancel] and then [Downloaded] once the download is complete.

For individual download, the selected area is given [Favorites]* status, Tap [X] on the title bar to close the [TZ MAPS Update] screen and complete the process.



*: Depending on the status of chart data, each area is classified and displayed into the following four types. [Favorites] switches between [Favorites] and [Downloaded] each time you tap an area.

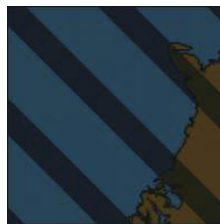

Not purchased



Not downloaded



Favorites



Download completed

16.6.3 How to display the MM3D charts catalog

The chart catalog shows the MM3D charts, satellite photos, tidal information, etc. incorporated in this equipment. To display the MM3D charts catalog, Home page→[Charts]→[MM3D Charts Catalog].

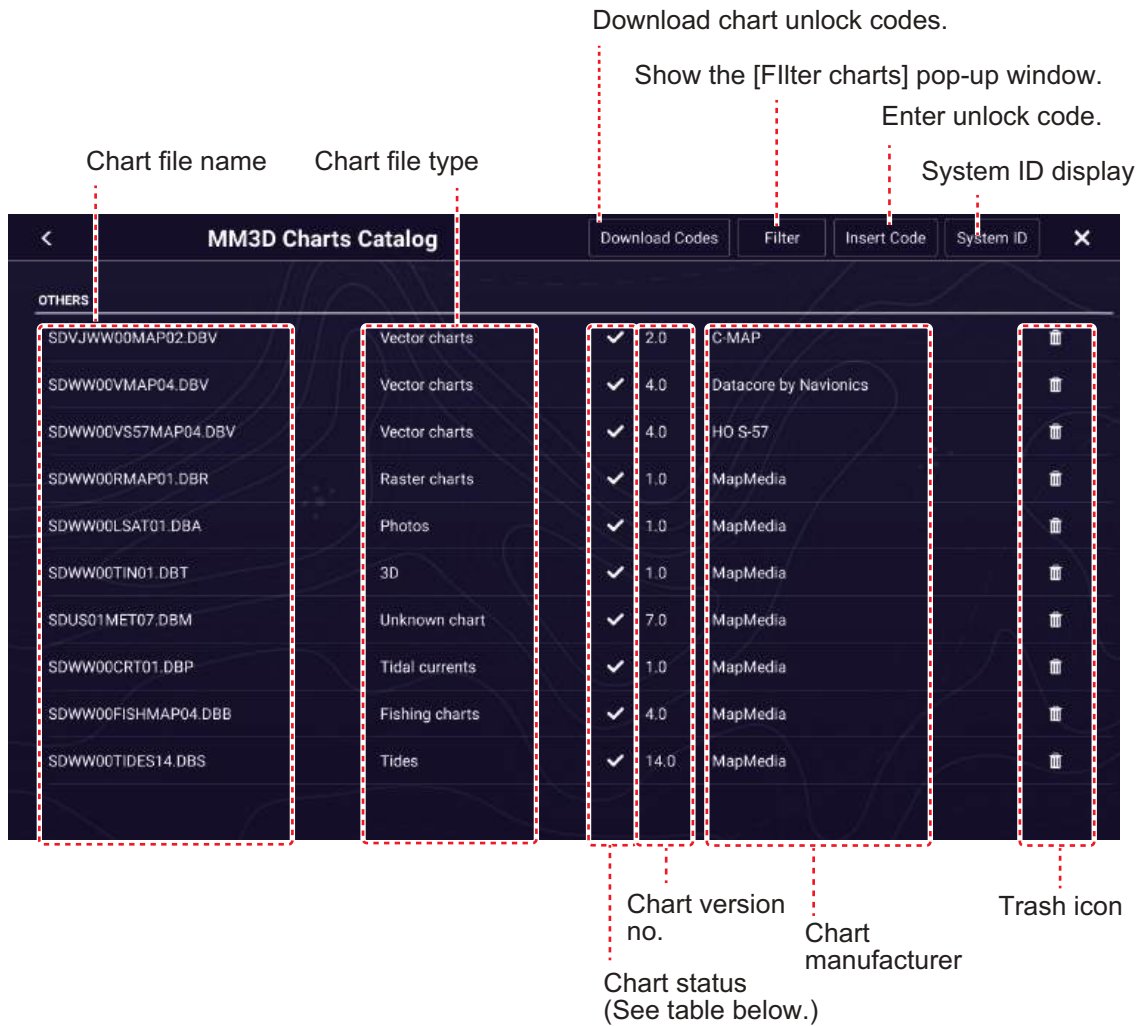



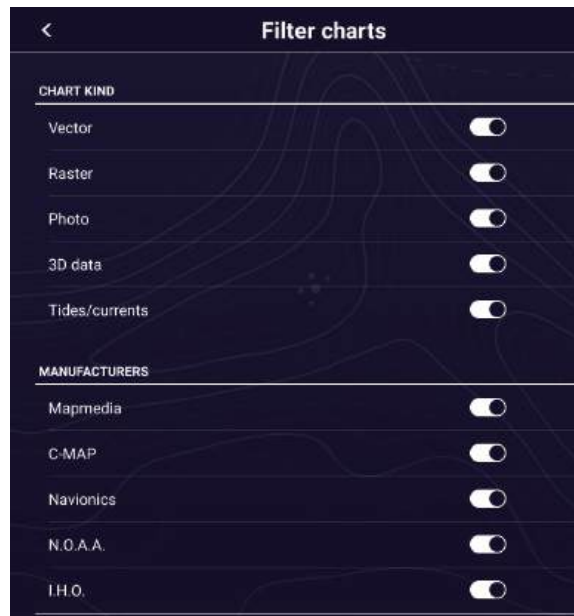

Chart status icon	Meaning
	Free chart. An unlock code is not necessary.
	Paid chart. Unlock code is necessary to use the chart. To unlock, tap [Insert Code] at the top of the [MM3D Charts Catalog] window. Enter the unlock code, then tap [✓] to finish.
	Paid chart. Unlock code entered.
	Chart cannot be used because it is corrupted.

How to hide unnecessary charts on the chart catalog list

1. Tap [Filter] on the chart catalog list title bar to show the [Filter charts] window.



2. Turn off items to hide in [Chart Kind], and [Manufacturers] (Mapmedia, C-MAP, Navionics, NOAA, IHO).
Note: To restore all items to default (all ON), tap [Reset Filters].
3. Tap [<] on the title bar to return to the chart catalog list. [Filter] on the title bar changes to [Change Filter].
4. Tap [×] to finish and close the chart catalog list.

16.6.4 How to add MM3D charts

For information on how to obtain a chart and its unlock code, contact place of purchase or the nearest FURUNO branch or sales office. Put the chart you obtained into a microSD card and insert it into the card slot on the back of the device. If you have added a paid chart, enter the unlock code (see section 16.6.3).

16.6.5 How to delete MM3D charts

To delete charts, Home page→[Charts]→[MM3D Chart Catalog]. Tap the trash can icon (right edge of screen) corresponding to the chart to delete. You are asked if you are sure to delete the chart. Tap [OK] to delete the chart.

16. OTHER FUNCTIONS

This page is intentionally left blank.

17. MAINTENANCE

This chapter provides information on maintenance and troubleshooting that the user can follow to care for the equipment and restore normal operation. If normal operation cannot be restored, do not attempt to open the equipment. Contact your FURUNO dealer for advice.

WARNING

ELECTRICAL SHOCK HAZARD
Do not open the equipment.

Only qualified persons can work inside the equipment.

NOTICE

Do not apply paint, anti-corrosive sealant or contact spray to plastic parts or equipment coating.

Those items contain products that can damage plastic parts and equipment coating.

17.1 Maintenance

Routine maintenance helps keep your equipment in good condition and prevents future problems. Check the items shown in the table below on a regular basis to help keep your equipment in good condition for years to come.

Check item	Check point	Remedy
Cables	Cable connection, corrosion	Connect loosened cables. Replace any damaged cables.
Cabinet	Dust on the cabinet	Remove dust with a dry, clean cloth. Do not use commercial cleaners to clean the equipment - they can remove paint and markings.
LCD	Dust on the LCD	Wipe the LCD carefully to prevent scratching, using tissue paper and an LCD cleaner. To remove dirt or salt deposits, use an LCD cleaner, wiping slowly with tissue paper so as to dissolve the dirt or salt. Change paper frequently so the salt or dirt will not scratch the LCD. Do not use solvents such as thinner, acetone or benzene for cleaning. Also, do not use a degreaser or anti-fog solution, as they can strip the coating from the LCD.
	Waterdrops on the LCD	Waterdrops on the LCD can slow touch response. Wipe the LCD with a dry, soft cloth to remove the water.
Radar antenna	Foreign material on the radar antenna	Foreign material can reduce sensitivity. Clean the antenna with a freshwater-moistened cloth. Do not use commercial cleaners to clean the radiator - they can remove paint and markings.

17.2 Replacement of Parts

Fuse replacement

If you cannot turn on the power, check the fuse to see if it has blown. If the fuse has blown, find the reason before you replace the fuse. Make sure to use a fuse rated 5 A for replacement. If the fuse blows again after the replacement, contact your dealer for advice.



Radar magnetron replacement

When a radar magnetron reaches the end of its life, targets do not appear on the radar display. If long-range performance appears to have declined, contact your dealer about replacement of the magnetron.

Radar Sensor	Magnetron	Approx. Life
DRS4DL+	80-0691	5,000 hours
DRS4D X-Class/ DRS4DL X-Class	M1653	
DRS6A X-Class*	MAF1562R	
DRS12A X-Class*	FNE1201	
DRS25A X-Class*	MG5436	

*: Not compatible with the TZMAP9/13.

The total time of power-on ("ON TIME") and transmission ("TX TIME") are displayed when the radar is in stand-by.

LCD replacement

The life of the LCD is approximately 50,000 hours. The actual life is affected by the operating environment (temperature, humidity, etc.). When nearing the end of its life-span, the LCD brilliance does not adjust correctly. When this occurs, contact your dealer for advice.

17.3 Troubleshooting

This section provides simple troubleshooting procedures that the user can follow to restore normal operation. If you cannot restore normal operation, do not check inside the unit. Have a qualified technician check the equipment.

17.3.1 General troubleshooting

Problem	Remedy
You can not turn on the power.	<ul style="list-style-type: none"> • Check if the system is in standby. • Check for blown fuse. • Check that the power connector is tightly fastened. • Check for corrosion on the power cable connector. • Check the power cable for damage. • Check the battery for correct voltage output.
Picture is not displayed properly.	<ul style="list-style-type: none"> • Turn the power off, then on again. If the picture is still improper, contact your dealer for advice.
The display has frozen.	Press the reset button located above the power button to turn off the unit, then turn the power on again.
No response after display is touched.	<ul style="list-style-type: none"> • Check if [Touch Screen] is locked on the [Quick Access] window. • Reset the power. If there is still no response, contact your dealer for advice.
The power of all connected TZTXL/TZT9E/13E devices can not be turned off at once.	Check that [Allow Remote Shutdown] setting is set to [ON].
Data is not received from the external device.	Check that Home page→[Settings]→[Initial Setup]→[Data Sensors]→[Sensor List]→tap the desired device→[Permission to use] setting is set to [ON].
Abnormal behavior such as operation without any operation by the user, random screen or setting changes, or system shutdown.	<ul style="list-style-type: none"> • Check if the remote control mode is enabled. • Check if any unfamiliar devices are registered in the sensor list (USB, NMEA 2000, LAN, wireless LAN), and check if an unauthorized device has been installed. If necessary, disable devices from the list. <p>Note: If there are any unfamiliar devices registered in the wireless LAN sensor list, the wireless LAN password may have been leaked. Change the wireless LAN password.</p>
Wireless LAN connection error.	Check that the WPA2 connection method supported by this unit is used. Note: The WPA, WEP cannot be used for this unit.

17.3.2 Chart plotter troubleshooting

Problem	Remedy
Position is not fixed.	<ul style="list-style-type: none"> • Check for interfering objects near the GPS antenna that may be blocking reception. • Check the GPS receiver. • Check that the GPS receiver connector is securely tightened and that it is connected correctly.
The track of your ship is not plotted.	Check if [Tracks Show Hide] in the Layers menu ([Overlays] tab) is turned on.

Problem	Remedy
Chart is not displayed after changing chart master settings.	Connect to the internet as shown below to get the chart unlock code. 1) If you are currently connected to the internet, disconnect from the internet. 2) Use wireless LAN to connect to the internet (see section 1.20). After connecting to the internet, approx. one minute later you can obtain the unlock code. 3) If you cannot obtain the unlock code, contact your dealer. Note: The above remedy is for the TZT9E/13E only.
Unlock code cannot be found.	Get the unlock code for the chart and cancel the unlock state (with the unit connected to the internet). Home page→[Settings]→[Charts]→[MM3D Charts Catalog]→[Download Codes]. It is not necessary to enter the chart unlock code manually.

17.3.3 Radar troubleshooting

Problem	Remedy
The radar does not transmit when the [TX] icon is operated.	<ul style="list-style-type: none"> • Tap the [TX] icon again. • Check if the power cable and LAN cable are tightly fastened. • Check if the radar source is correctly set and connected.
Marks and characters appear, but echoes do not appear.	Check if the power cable and LAN cable are tightly fastened.
Picture is not updated or the picture freezes.	<ul style="list-style-type: none"> • Check if the power cable and LAN cable are tightly fastened. • Check if this unit is powered.
You adjusted the receiver gain, but radar echoes are too weak.	The magnetron in the radar sensor may have deteriorated. Have a qualified technician check the magnetron.
You changed the range, but the radar picture does not change.	<ul style="list-style-type: none"> • Try to change the range again. • Reset the power.
Poor discrimination in range.	Adjust the sea clutter removal control.
Range rings are not displayed.	Check if [Range Rings] is turned on in the [Overlays] tab of the Layers menu.
You tapped the [TX] icon to transmit. The "TX screen" appears momentarily, but the radar soon goes into stand-by.	The overload protection has activated. To restore normal operation, turn off all equipment in the network. Wait a few seconds then turn on all the equipment.

17.3.4 Fish finder troubleshooting

Problem	Remedy
You selected a fish finder display from the Home page, but no picture appears.	<ul style="list-style-type: none"> • Check that the fish finder source is correctly selected. • Check if the fish finder is correctly connected. • Check if the external fish finder is correctly connected. • Check if the picture advance setting (Home page→[Settings]→[Fish Finder]→[User Settings]→[Picture Advance]) is set to [Stop].
Marks and characters appear, but no picture appears.	<ul style="list-style-type: none"> • Check if the picture advance setting (Home page→[Settings]→[Fish Finder]→[User Settings]→[Picture Advance]) is set to [Stop].

Problem	Remedy
Picture appears but zero line does not appear.	<ul style="list-style-type: none"> • The picture is shifted. Drag the picture up or down to show the zero line. • Check if the draft setting (Home page→[Settings]→[Fish Finder]→[Fish Finder Initial Setup]→[Transducer Draft]) is zero (0) or higher. • Check if [Zero Line Rejection] (Home page→[Settings]→[Fish Finder]→[Fish Finder Initial Setup]) is turned off.
The picture sensitivity is too low.	<ul style="list-style-type: none"> • If you are in the manual mode, check the gain setting. • Check the transducer face for marine life and air bubbles. • Bottom is too soft to return an acceptable echo.
The depth indication does not appear.	Adjust the bottom level.
Noise or interference shows on the display.	<ul style="list-style-type: none"> • Check the ground for tight connection, corrosion. • Check if another fish finder near your boat has the same frequency as your fish finder. • Try to reject the interference with [Interference Rejection] (Home page→[Settings]→[Fish Finder]→[User Settings]).

This page is intentionally left blank.

APPX. 1 MENU TREE

Factory default settings in bold italic.
Underlined menus are for the TZT9E/13E only.

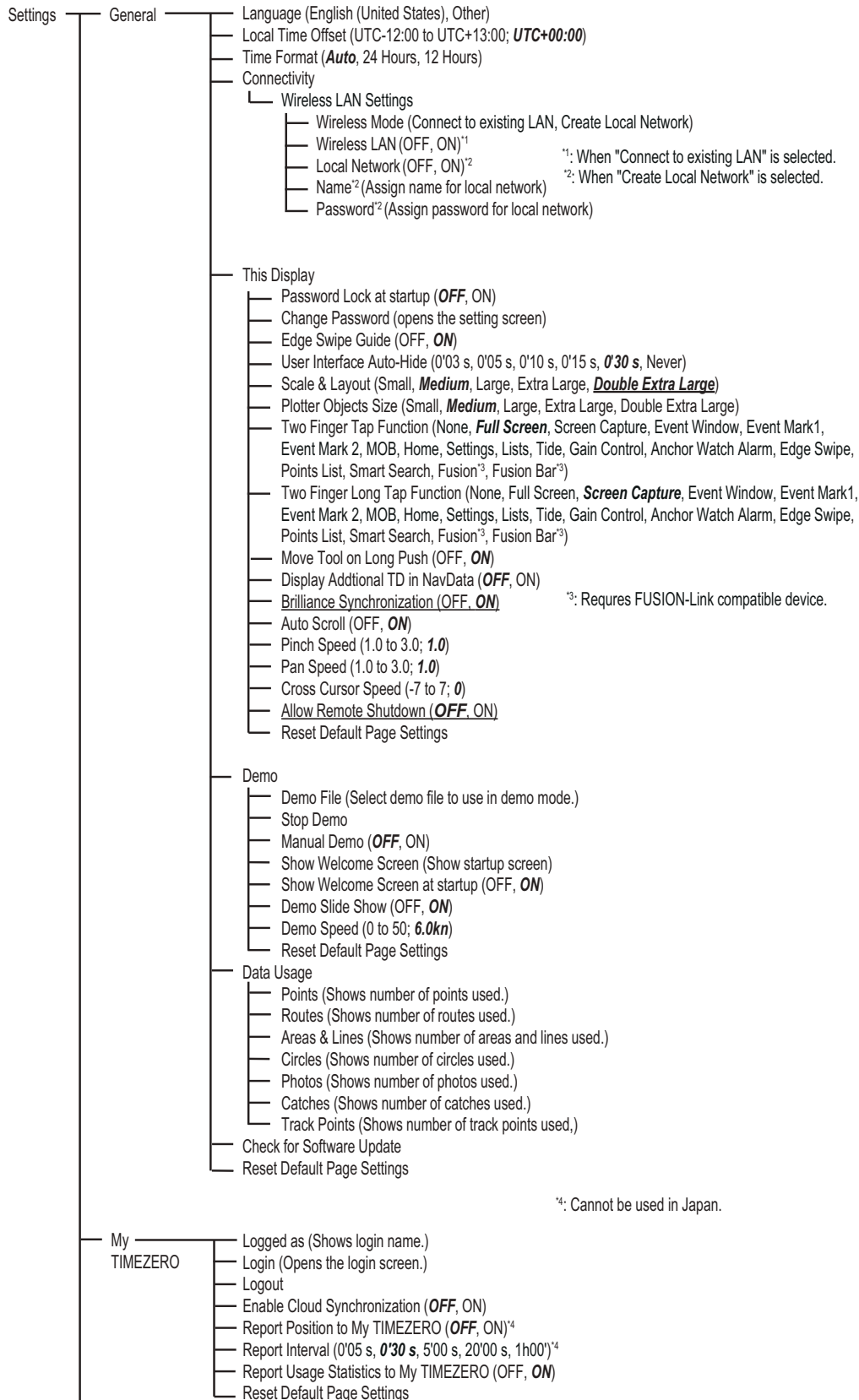

⁴: Cannot be used in Japan.

APPX. 1 MENU TREE

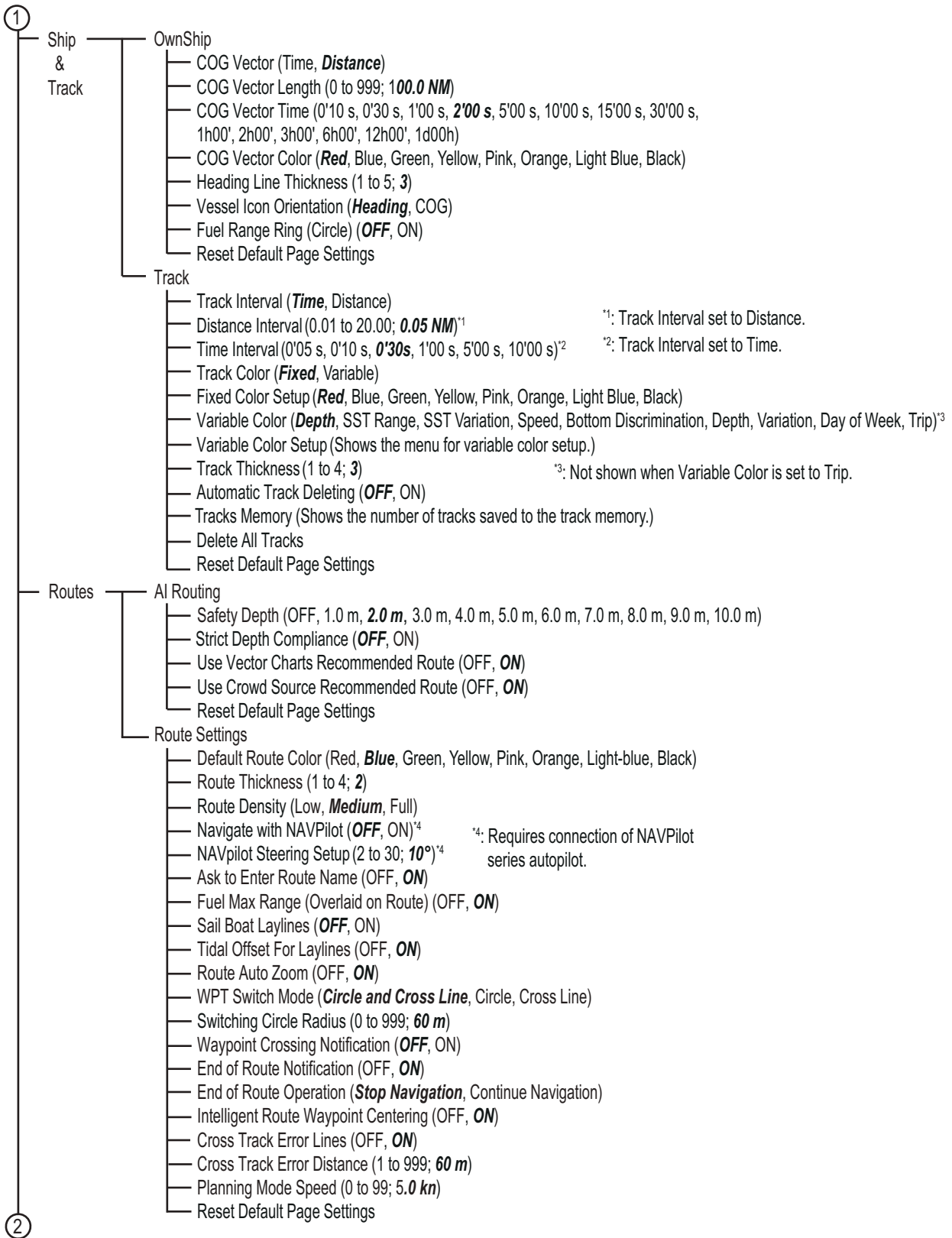

2

Points & Boundaries

Points

- Default Point Symbol (Select default point symbol. See figure below.)
- Default Point Color (Red, Blue, Green, **Yellow**, Pink, Orange, Cyan, Black)
- Point Size (1 to 100; **15%**)
- Icons Set (**Modern**, Classic)
- Point Density (Low, **Medium**, Full)
- Display Point Names (OFF, **ON**)
- Automatic Naming (OFF, **ON**)
- Automatic Naming Prefix (Input from software keyboard; default: WP)
- Reset Default Page Settings

Events

- Data to Be Recorded in Event Comment (**None**, Date, SST, Date and SST)
- Event Button Short Tap (**Event Window**, Event Mark 1, Event Mark 2, Screen Capture, Anchor Watch Alarm, MOB, Points List)
- Event Button Long Tap (Event Window, **Event Mark 1**, Event Mark 2, Screen Capture, Anchor Watch Alarm, MOB, Points List)
- Event Mark 1 to 6 default shape (Select event mark shape. See the figure below.)
- Event Mark 1 to 6 default color (Red, Blue, Green, Yellow, Pink, Orange, Cyan, Black. See figure below.)
- Reset Default Page Settings

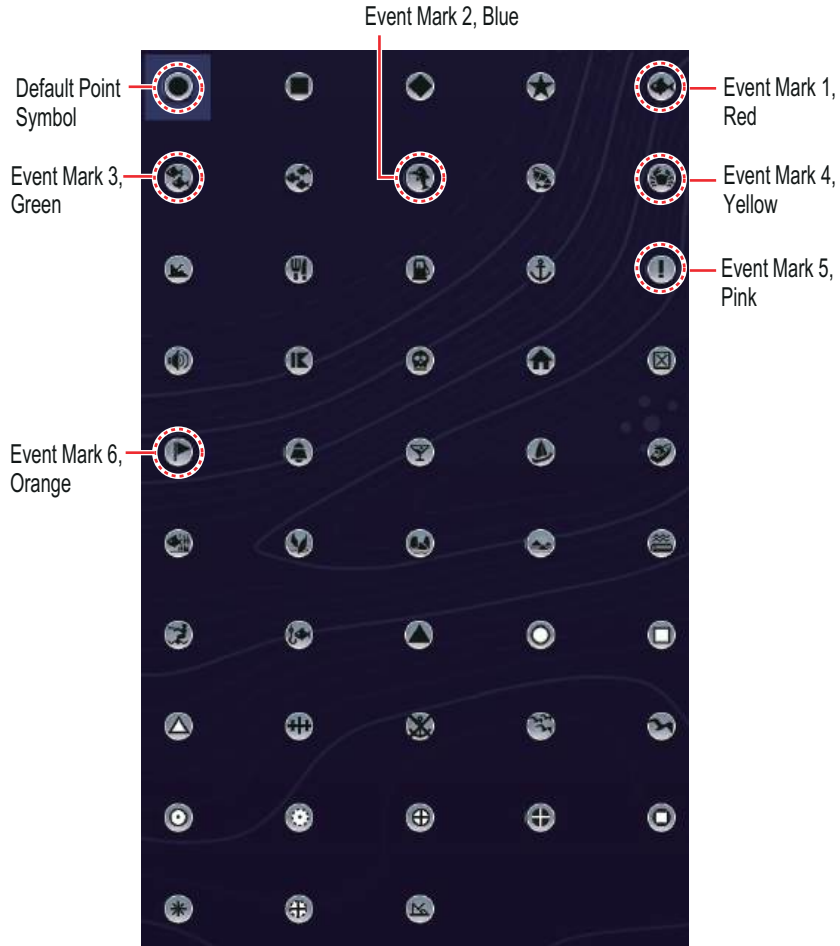

Boundaries

- Default Boundary Color (Red, Blue, Green, **Yellow**, Pink, Orange, Cyan, Black)
- Default Boundary Transparency (0 to 100; **40%**)
- Default Boundary Contour (———— , - - - - , , - . - . : ———— factory default setting)
- Reset Default Page Settings

3

Delete All User Objects

APPX. 1 MENU TREE

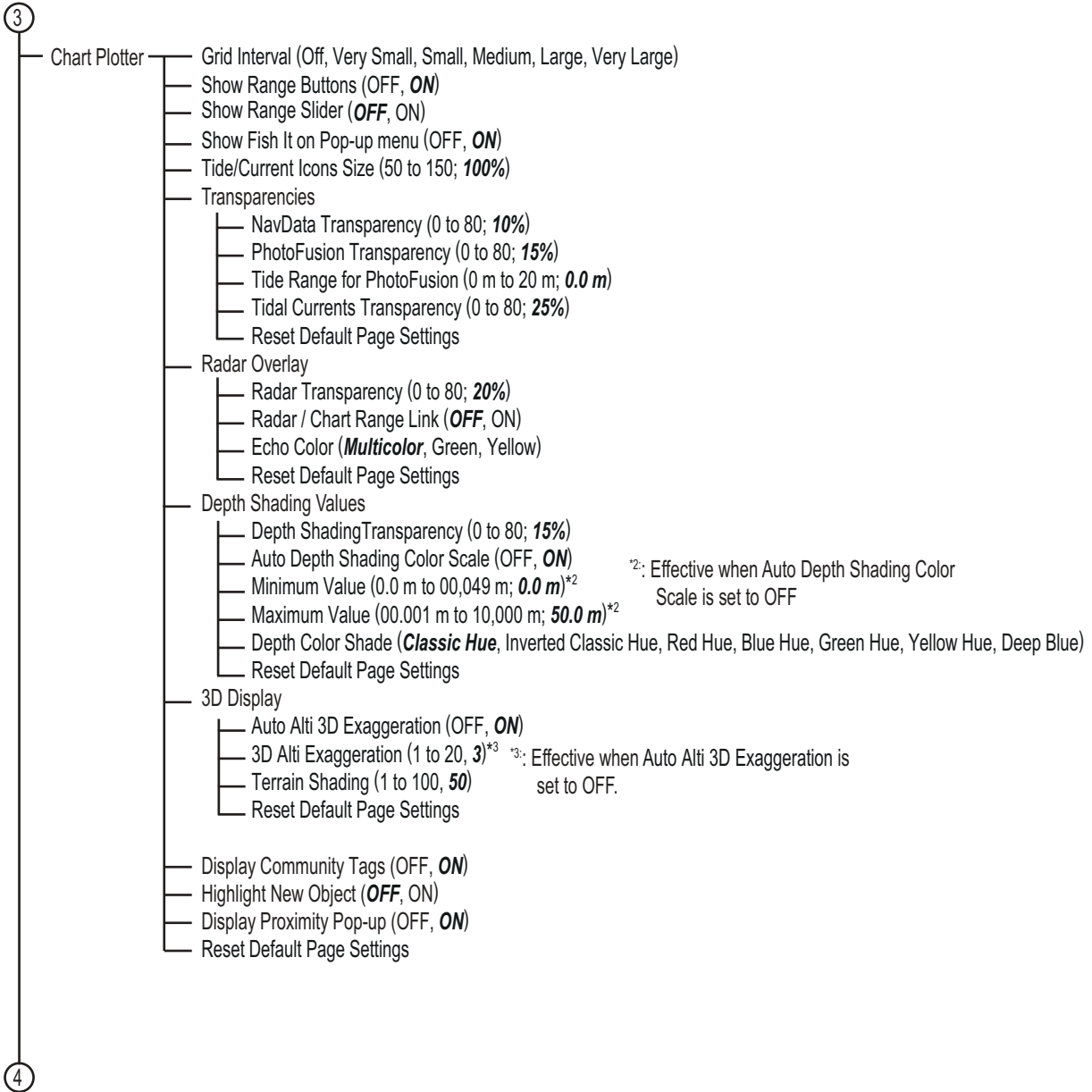

4

- TZ MAPS
 - Color Theme (Standard, Official S-52, **Sunlight**, SHOM, CHS, NOAA, Explorer, Cruise)
 - Style (Simplified, **Paper Chart**)
 - Land Features (Off, **OSM**, Official S-52)
 - Object Size (50 to 150; **100%**)
 - Shallow Water (0.0m, **1.0 m**, 2.0 m, 3.0 m, 4.0 m, 5.0 m, 6.0 m, 7.0 m, 8.0 m, 9.0 m, 10.0 m)
 - Safety Water (0.0m, 1.0 m, **2.0 m**, 3.0 m, 4.0 m, 5.0 m, 6.0 m, 7.0 m, 8.0 m, 9.0 m, 10.0 m, 15.0 m, 20.0m, 30.0m, 50.0 m)
 - Deep Water (0.0 m, 1.0 m, 2.0 m, **3.0 m**, 4.0 m, 5.0 m, 6.0 m, 7.0 m, 8.0 m, 9.0 m, 10.0 m, 15.0 m, 20.0 m, 30.0 m, 50.0 m, 100 m, 200 m, 300 m, 500 m)
 - Lights (OFF, **ON**)
 - Lights Description (OFF, **ON**)
 - Display Mode (**Simple Sectors**, Real Range Sectors)
 - Buoys And Beacons (OFF, **ON**)
 - Buoys Numbers (Fuel Name, **Number Only**, Off)
 - Daymarks Names (OFF, **ON**)
 - Depth Information (OFF, **ON**)
 - Depth Contours (OFF, **ON**)
 - Depth Soundings (OFF, **ON**)
 - Red When Shallowed (OFF, **ON**)
 - Shallow Depth (0.0 m, 1.0 m, **2.0 m**, 3.0 m, 4.0 m, 5.0 m, 6.0 m, 7.0 m, 8.0 m, 9.0 m, 10.0 m, 15.0 m, 20.0 m, 30.0 m)
 - Obstructions (OFF, **ON**)
 - Cables (OFF, **ON**)
 - Depth Below Safety (**OFF**, ON)
 - Routes (OFF, **ON**)
 - Information Areas (OFF, **ON**)
 - Cautionary Areas (OFF, **ON**)
 - Service And Facilities (OFF, **ON**)
 - Nature Of Seabed (OFF, **ON**)
 - Currents And Magnetics (**OFF**, ON)
 - Advanced Settings
 - Chart Data Coverage (OFF, **ON**)
 - Meta Informations (**OFF**, ON)
 - Shallow Pattern (**OFF**, ON)
 - Navigation Rails (OFF, **ON**)
 - Area Boundaries (Symbolized, **Plain**)
 - Textual Information (National (local language), International (English), **Auto Mode**)
 - Reset Default Page Settings
 - Text (Off, Important Only, **All**)
 - XTRA DATA (OFF, **ON**) (Data names are displayed when other data is included in the downloaded TZ MAPS database. The data names can be set to ON/OFF.)
- Reset Default Page Settings

5

5

Fish
Finder

Fish Finder Initial Setup

- Transducer Setup (Opens the dialog box for transducer setting.)
- Preset Frequency Setup (preset frequency 1, 2, or 3)¹
- Zero Line Rejection (OFF, **ON**)
- Zero Line Range (1.4 to 3.8; **2.0**)^{2,3}
- Transducer Draft (0.0 to 99; **0.0m**)
- Salt Water (OFF, **ON**)
- Transmission Format (**Parallel**, SequentialA, SequentialB)⁴
- Transmission Power Mode (**Manual**, Auto)⁵
- External KP (OFF, ON)⁶
- Bottom Level (Bottom Level (HF), Bottom Level (MF), Bottom Level (LF)) (-40 to +40)⁷
- Gain Offset (Gain Offset (HF), Gain Offset (MF), Gain Offset (LF)) (-50 to +50)⁷
- Auto Gain Offset (Auto Gain Offset (HF), Auto Gain Offset (MF), Auto Gain Offset (LF)) (-5 to +5)^{7, 8}
- STC (STC HF, STC MF, STC LF) (0 to 10)⁹
- TX Pulse (TX Pulse HF, TX Pulse MF, TX Pulse LF) (Short 1, Short 2, **Standard**, Long)¹⁰
- RX Band (RX Band HF, RX Band MF, RX Band LF) (Narrow, **Standard**, Wide)¹¹
- Temperature Port (**MJ Port**, Low Frequency, High Frequency)¹²
- Reset Default Page Settings

*: See the descriptions on the next page for items marked with asterisks.

User Settings

- Fish Finder Source (TZTEFF, connected network fish finder)
- Day Background Color (**White**, Light Blue, Black, Dark Blue, Blue, Green)
- Night Background Color (**Black**, Dark Blue, Blue)
- Echo Color Levels (8 Colors, 16 Colors, **64 Colors**)
- Digital Depth Size (**Small**, Medium, Large)
- Color Erase (0 to 50; **0%**)
- Show Range Buttons (OFF, **ON**)
- Show Range Slider (OFF, **ON**)
- A-Scope Peak Hold (OFF, ON)
- Cancel Smoothing (OFF, **ON**)
- Split Range (OFF, ON)
- Bottom Search Mode (OFF, ON)
- Picture Advance (4/1, 2/1, **1/1**, 1/2, 1/4, 1/8, 1/16, Stop)
- Bottom Range Shift Area (15 to 85; **80%**)
- Zoom Range Span (2 to 200; **10.0 m**)
- Bottom Lock Range Span (2 to 200; **10.0 m**)
- Marker Zoom Shift (0 to 2,000; **10.0 m**)
- Interference Rejection (**Off**, Low, Medium, High, Auto)
- Color Range Expansion (OFF, **ON**)¹³
- Heaving Correction (OFF, **ON**)
- Echo Stretch (OFF, ON)¹⁴
- HF Clutter, MF Clutter, LF Clutter (0 to 100; **0%**)⁷
- TVG Distance HF, TVG Distance MF, TVG Distance LF (30 to 1000; **200 m**)^{7, 15}
- HF TVG, MF TVG, LF TVG (0 to 9; **5**)⁷
- Transmit Rate Mode (**Manual**, Auto)¹⁶
- Transmit Rate Manual Value (0 to 20, **20**)¹⁷
- Fish Finder Transmit (OFF, ON)
- Reset Default Page Settings

ACCU-FISH¹⁸

- ACCU-FISH Info (**Fish Size**, Depth)
- ACCU-FISH Symbols (Off, **Solid**, Striped)
- ACCU-FISH Minimum Size (00.00 to 79.98; **0.0 in**)
- ACCU-FISH Size Correction (-80 to 100, **0%**)
- Reset Default Page Settings

Fish Finder Alarms

- Fish Alarm (OFF, ON)
- Range Minimum Value (0 to 999; **0.0 m**)¹⁹
- Range Maximum Value (1 to 1,000; **3.0 m**)¹⁹
- Fish Alarm for Bottom Lock (OFF, ON)
- Range Minimum Value (0 to 999; **0.0 m**)¹⁹
- Range Maximum Value (1 to 1,000; **3.0 m**)¹⁹
- Fish Alarm Level (Low, **Medium**, High)
- Reset Default Page Settings

Fish Finder Demo (OFF, Shallow, Deep)²⁰

Set Hardware to Factory Default

Reset Default Page Settings

6

- *1: TZMAP9/13, or when TZTEFF (TZT9E/13E) , TZTXFF, TZT9F/12F/16F/19F, DFF3-UHD, DFF1UHD+ is selected for the [Fish Finder Source].
- *2: TZMAP9/13, or when TZTEFF (TZT9E/13E) , TZTXFF, DFF3, DFF3-UHD, DFF1UHD+, TZT12F/16F/19F with DI-FFAMP is selected for the [Fish Finder Source].
- *3: DFF3: 1.4 to 2.5; **2.0**.
- *4: DFF3-UHD (program version: 0252480-02.04 or later), TZT12F/16F/19F with DI-FFAMP. DFF3-UHD (program version: 0252480-02.04 or later) equipped with time delay transmission.
- *5: - TZMAP9/13, or when TZTEFF (TZT9E/13E) , TZTXFF, DFF1UHD+, TZT9F/12F/16F/19F (no DI-FFAMP) is selected for the [Fish Finder Source]: Min, **Max**.
 - DFF3-UHD: **Auto**, Man (0 to 10). For Man, adjustment slider bar appears.
 - TZT12F/16F/19F with CHIRP transducer and DI-FFAMP: **Auto**, 1 to 10. Adjustment slider bar appears.
 - DFF1-UHD: Off, Min, **Auto**.
 - DFF1, BBDS1, DFF3: 0 to 10. Adjustment slider bar appears.
- *6: Fish finder source other than TZTEFF, TZT2BB, BBDS1, DFF1, or other than TZMAP9/13.
- *7: Menu changes according to transducer. HF/MF/LF not shown with single freq. transducer.
- *8: Effective in auto mode only.
- *9: DFF3, DFF1-UHD, DFF3-UHD, TZT12F/16F/19F with DI-FFAMP.
- *10: DFF3, DFF3-UHD, TZT12F/16F/19F with DI-FFAMP and narrowband transducer.
- *11: DFF3, DFF3-UHD.
- *12: DFF3, DFF1-UHD.
- *13: TZMAP9/13, or when TZTEFF (TZT9E/13E) , TZTXFF, TZT9F/12F/16F/19F, DFF3-UHD, DFF1UHD+ is selected for the [Fish Finder Source].
- *14: DFF3-UHD (program no. 025480-02.04 or later).
- *15: TZMAP9/13, or when TZTEFF (TZT9E/13E) , DFF3-UHD, DFF1UHD+, TZTXFF is selected for the [Fish Finder Source].
- *16: No display for DFF3-UHD. No auto setting for built-in fish finder of TZT10X/13X/16X, DFF1UHD+, TZTEFF, or TZMAP9/13.
- *17: Displayed when Transmit Rate Mode is set to Manual.
- *18: Displayed when connected to ACCU-FISH™ compatible transducer.
- *19: Setting range for internal fish finder (setting range is different for network fish finder).
- *20: - BBDS1, DFF1, DFF3.
 - TZT9F/12F/16F/19F: **Off**, Demo 1 to Demo 4.
 - TZTXFF, or DFF1UHD+: **Off**, Demo 1, Demo 2.
 - TZMAP9/13, or when TZTEFF (TZT9E/13E) is selected for the [Fish Finder Source]: **Off**, Demo 2.

APPX. 1 MENU TREE

6

Sonar

User Settings

- TX Interval (**Fixed 1** to 9, Random 1 to 4, External SYNCH)
- Tx Pulse Length (1 to 10; **1**)
- Tx Power (1 to 10; **1**)
- Frequency Shift (81.5 to 85.5; **81.5**)
- Horizontal Beam Width (1 to 5; **1**)
- Vertical Beam Width (1 to 5; **1**)
- Near Gain (0.0 to 10.0; **0.0**)
- Far Gain (0.0 to 10.0; **0.0**)
- AGC Near (0.0 to 10.0; **0.0**)
- AGC Far (0.0 to 10.0; **0.0**)
- Noise Suppression (**0**, 0.5, 1, 1.5, 2, 2.5, 3, 3.5, 4, 4.5, 5, 5.5, 6, 6.5, 7, 7.5, 8, 8.5, 9, 9.5, 10)
- Noise Suppression (SHIP) (0.0 to 10.0; **0.0**)
- Noise Limiter (0 to 10, **0**)
- Signal Level (0 to 31; **0**)
- Echo Average (0 to 11; **0**)
- Interference Rejector 1 (**OFF**, Weak, Strong)
- Interference Rejector 2 (0 to 6; **0**)
- Smooth Echo Range (0 to 5; **0**)
- Smooth Echo Circular (0 to 4; **0**)
- Reset Default Page Settings

Sonar Settings

- Auto Tilt (**OFF**, ON)
- Auto Tilt Upper End*¹ (-5 to 60; **0**)
- Auto Tilt Lower End*¹ (-5 to 60; **0**)
- Auto Tilt Angle*¹ (1 to 5; **1**)
- Auto Tilt TX Count*¹ (1 to 5; **1**)
- SCAN SETTING 1/2
- Reset Scan Setting 1/2
- Reset Range 1/2 (**OFF**, ON)
- Reset Range Distance 1/2 (50 to 2,000; **50 m**)
- Reset Tilt 1/2 (**OFF**, ON)
- Reset Tilt Angle 1/2 (-5 to 60; **-5**)
- Reset Gain 1/2 (**OFF**, ON)
- Reset Gain Value 1/2 (0.0 to 10.0; **0**)
- Auto Retraction (**OFF**, ON)
- Auto Retraction Speed (5 to 18; **5 kn**)
- TX/STBY (**OFF**, ON)
- Heading Align (-179 to +180; **0**)
- Reset Default Page Settings

*¹:Availabe when [Auto Tilt] is set to [ON].

Program Key Setup

- Program 1 to 10
 - Nickname
 - Save

7

7

Radar

Radar Initial Setup

- Own Ship Icon (OFF, **ON**)
- Bearing Scale Mode (True, **Relative**)
- EBL Reference (True, **Relative**)
- Antenna Rotation (**Auto**, 24 RPM)
- Antenna Heading Align (-179.9 to +180.0; **+0.0°**)
- Main Bang Suppression (0 to 100; **50**)
- Enable Sector Blanking (**OFF**, ON)
- Start Angle (0 to 359; **0°**)*1
- End Angle (0 to 359; **0°**)*1
- Enable Sector 2 Blanking (**OFF**, ON)
- Start Angle (0 to 359; **0°**)*1
- End Angle (0 to 359; **0°**)*1
- Position from Bow (0 to 999, **6.0 m**)
- Position from Port (-99.0 to +99.0, **0.00 m**)
- Height from Surface (DRS: Under 3 m, **3 m - 10 m**, Over 10 m)*2
(IMO: 5 m, **7.5 m**, 10 m, 15 m, 20 m, 25 m, 30 m, 35 m, 40 m, 45 m, 50 m)
- Antenna Length (1.0 m, **1.2 m**, 1.8 m)*2
- Auto Tuning (OFF, **ON**)*3
- Tuning Source (**Range1**, Range2)*2,*3
- Manual Tuning (-50 to 50; **0**)*3,*4
- Radar Monitoring (Shows information about radar sensor.)
- Radar Optimization (Automatically adjust magnetron output and tuning for the connected radar.)
- ARPA Advanced Settings (Shows menu for setting up ARPA.)
- TX Channel (**Auto**, 1, 2, 3)*5
- Auto Acquire by Doppler (OFF, **ON**)*5
- Reset Default Page Settings

*1: Available when Sector Blanking 1 or Sector Blanking 2 is activated.

*2: Not available with DRS4DL+.

*3: Not shown with DRS6A/12A/25A-NXT.

*4: Available when Auto Tuning is OFF.

*5: Available with DRS6A/12A/25A-NXT.

User Settings

- Radar Source (Select the antenna host name.)
- Day Background Color (**Black**, Dark Blue, White)
- Night Background Color (**Black**, Dark Blue)
- Echo Color (**Multicolor**, Green, Yellow)
- Rings Interval (**Automatic**, 1 Ring, 2 Rings, 3 Rings, 4 Rings, 5 Rings, 6 Rings, 7 Rings, 8 Rings, 9 Rings)
- Show Range Buttons (**OFF**, ON)
- Show Range Slider (OFF, **ON**)
- Reset Default Page Settings

Watchman (5'00s, 10'00 s, **20'00 s**)

Trail

- Trail Color (**Blue**, Yellow, Green)
- Trail Length (0'15 s, 0'30 s, 1'00 s, **3'00 s**, 6'00 s, 15'00 s, 30'00 s, Continuous)
- Trail Shade (Single, **Multí**)
- Trail Mode (Relative, **True**)
- Reset Default Page Settings

Set Hardware To Factory Default

Reset Default Page Settings

CHIRP

Side

Scan*6

- CHIRP Side Scan Source (Select CHIRP side scan sensor.)
- Echo Color (**White**, Blue, Brown, Green, Tuna Hunter, Aqua Marine, Fury, Volcano)
- Show Range Buttons (OFF, **ON**)
- Show Range Slider (**OFF**, ON)
- Picture Advance (4/1, 2/1, **1/1**, 1/2, 1/4, 1/8, 1/16, Stop)
- Clutter (0 to 100; **20**)
- Transducer Draft ((0.0 to 99.9(m), **0.0 m**))
- Salt Water (OFF, **ON**)
- Bottom Level (-00.1 to +40, **0**)
- Transmit Rate (0 to 20, **20**)
- Transducer Mis-mount Correction (**OFF**, ON)
- Set Hardware to Factory Default
- Reset Default Settings

*6: Requires compatible transducer.

8

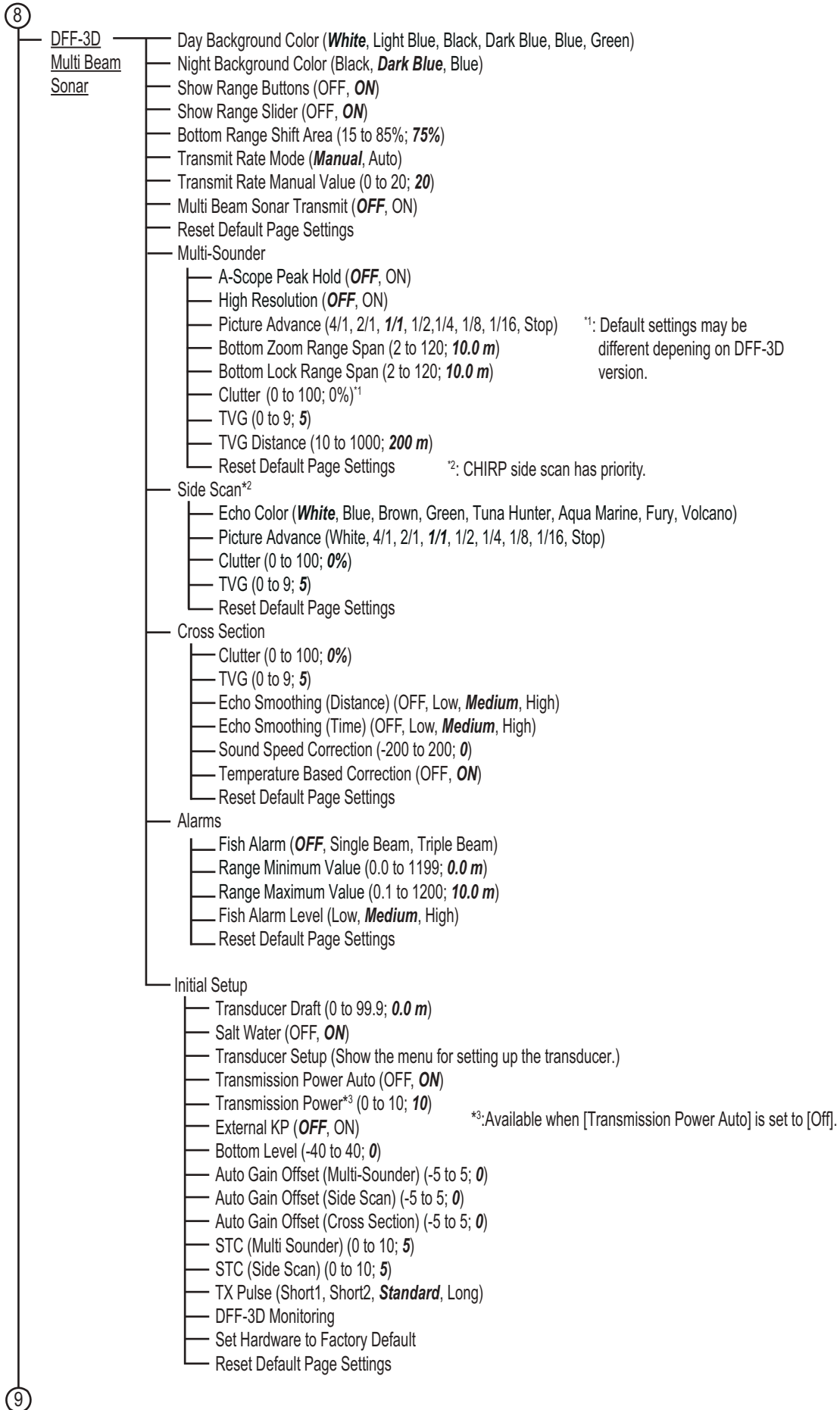

9

Weather

Sirius XM Weather*1

*1: Shown only when Sirius is available.

- Sirius XM Weather Radar (**US Now Radar**, Canadian Radar)
- Zone Forecast
- Marine Warnings
- Tropical Infos
- Weather Color Transparency (0 to 80; **40**)
- Sea Surface Temperature (SST)

- Auto SST Color Scale (OFF, **ON**)
- Minimum Value (-10°C to 50°C; **10°C**, 15°F to 120°F; **50°F**)
- Maximum Value (0°C to 50°C; **30°C**, 30°F to 120°F; **90°F**)
- Reset Default Page Settings

- Autodownload at boot (**OFF**, ON)
- Particule Trail Length (Short, Medium, **Long**, Very Long)
- Weather Color Transparency (0 to 80; **10**)
- Restrict Download Size (**OFF**, ON)
- Restricted Download Size in MB*2 (0.0 to 50.0; **5.0**)
- Duration of Animation (0'05s, 0'10s, 0'15s, 0'20s, 0'30s, **0'45s**, 1'00s, 2'00s, 3'00s)
- Tidal Update Interval (5'00s, **10'00s**, 15'00s, 20'00s, 30'00s, 1h00', 2h00', 3h00', 6h00', 12h00')
- Fish Mapping Settings*3

*2: Shown only when download size setting is set to ON.

*3: Shown only when Fish Mapping is available.

- SST Contours Min (-3°C to 32°C; **-3°C**, 26.60°F to 89.60°F; **26.60°F**)
- SST Contours Max (-3°C to 32°C; **32°C**, 26.60°F to 89.60°F; **89.60°F**)
- -30m Temp. Contours Min (-3°C to 32°C; **-3°C**, 26.60°F to 89.60°F; **26.60°F**)
- -30m Temp. Contours Max (-3°C to 32°C; **32°C**, 26.60°F to 89.60°F; **89.60°F**)
- SSH Anomaly Contours Min (-250 cm to 250 cm; **-250 cm**, -98 in to 98 in; **-98 in**)
- SSH Anomaly Contours Max (-250 cm to 250 cm; **250 cm**, -98 in to 98 in; **98 in**)
- Reset Default Page Settings

Reset Default Page Settings

Targets

- Display Target IDs (**OFF**, ON)
- Ignore AIS Targets Slower than... (0.0 to 9.9; **1 kn**)
- Target Icon Size (50 to 200, **100**)
- AIS Message Notification (OFF, **ON**)
- Collision Alarm (Off, **Risk Visualizer**, CPA/TCPA)
- CPA Alarm Value (0.01 to 99.99; **0.5 NM**)⁴
- TCPA Alarm Value (0.01 to 59; **10'**)⁴
- CPA Graphic Display (OFF, **ON**)
- Proximity AIS Target Alarm (**OFF**, ON)
- Proximity AIS Target Alarm Value⁵ (0.00 to 5.000⁶; **100m**)
- Buddies List (AIS & DSC) (Opens the buddies list.)
- Reset Default Page Settings

⁴: Valid when Collision Alarm is set to CPA/TCPA.

⁵: Valid when AIS Proximity Alarm is ON.

⁶: Setting range changes according to Range (Long) setting in Units menu.
 • NM: 0.001 to 5.000
 • KM: 0.001 to 9.000
 • Mile: 0.001 to 6.000

10

10

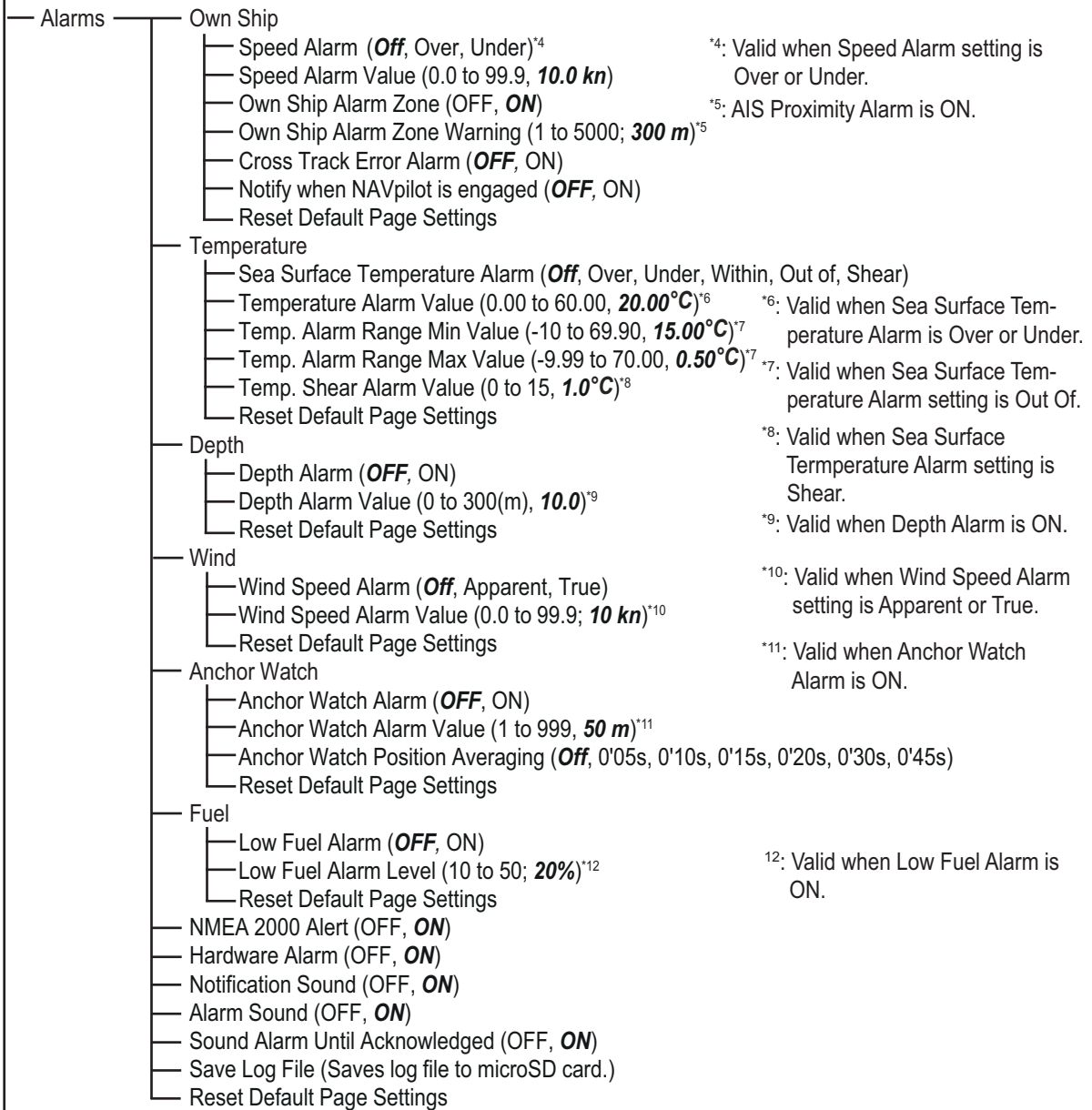

11

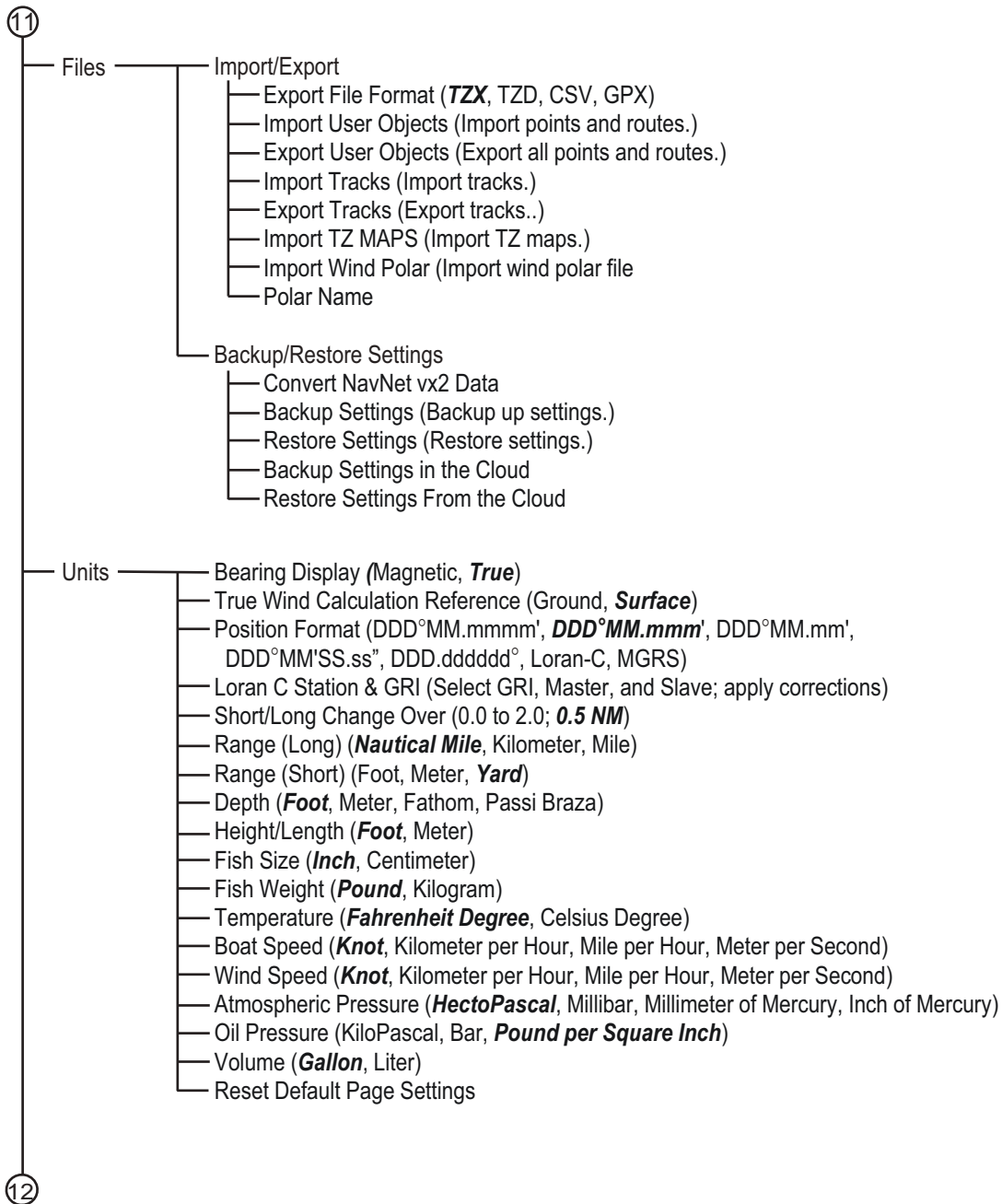

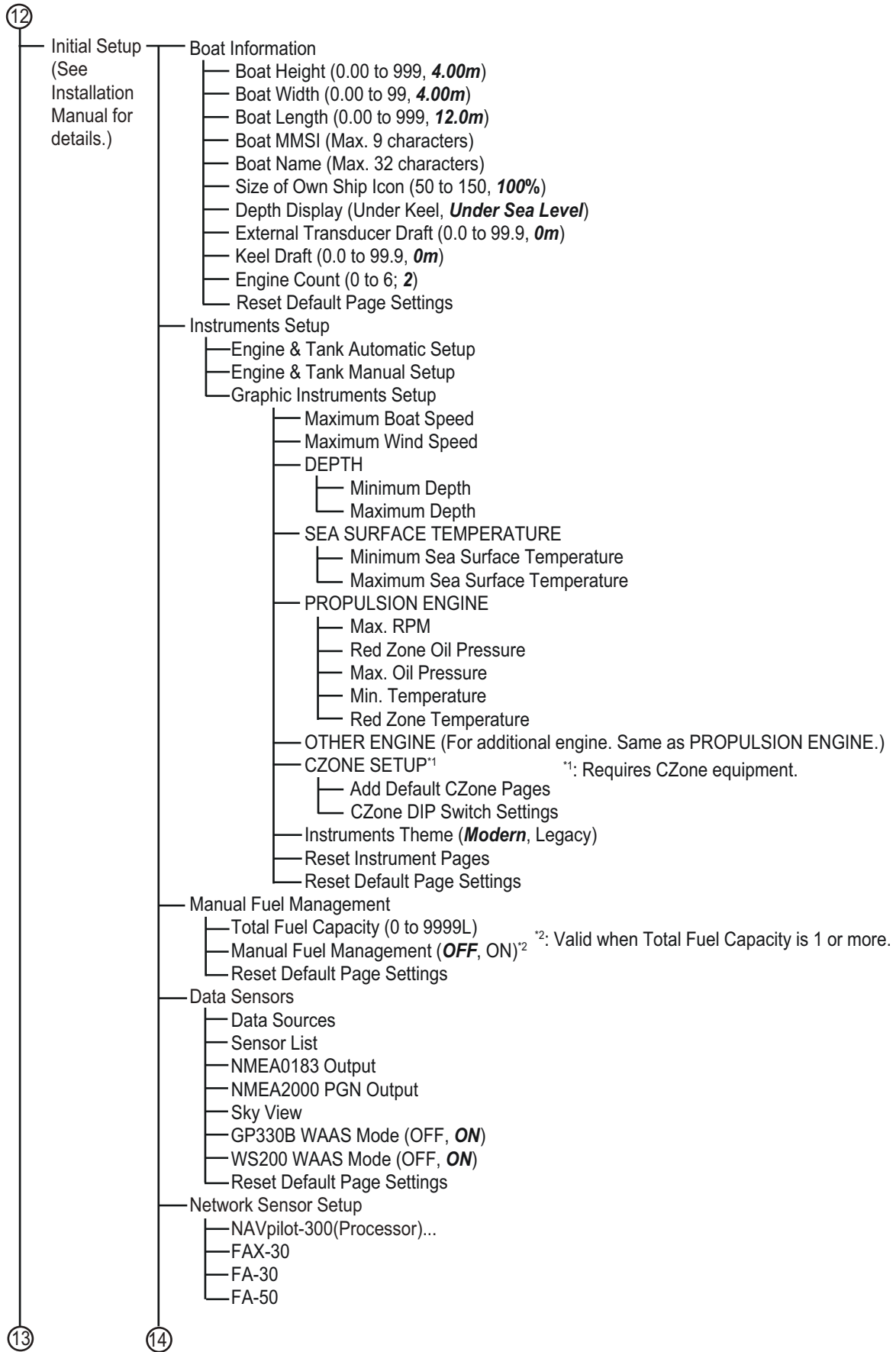

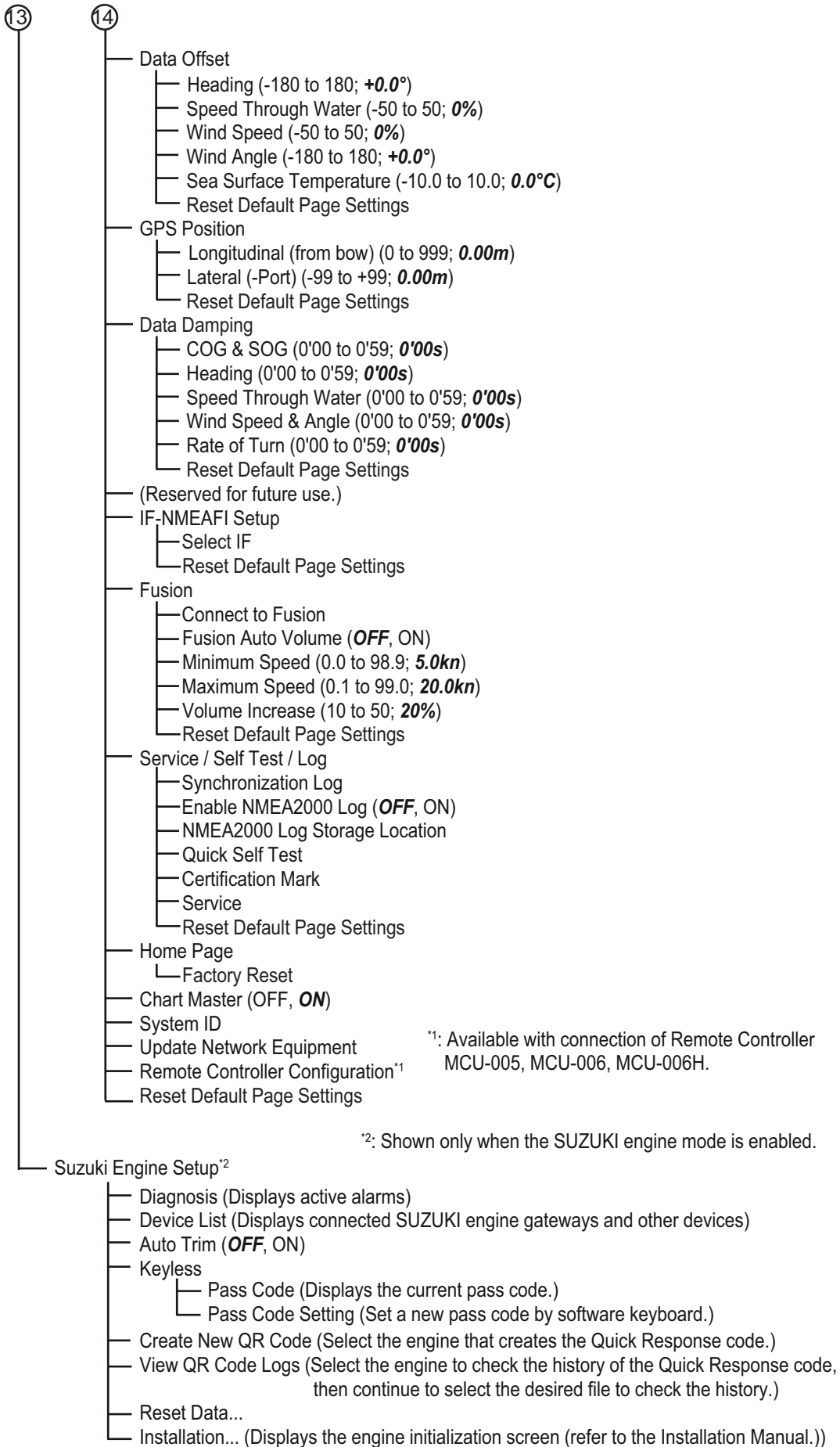

APPX. 2 TRANSDUCER LIST

The tables below show all available transducers, whether they are compatible with the functions listed, and connection port.

Standard transducers (CW narrow band)

Model	ACCU-FISH™	Bottom Discrimination	Port to be connected	Power Rating	
520-5PSD	Yes	Yes	XDR1	600 W	
520-5MSD	Yes	Yes			
525-5PWD	Yes	Yes			
525STID-MSD	Yes	Yes			
525STID-PWD	Yes	Yes			
520-PLD	Yes	Yes			
525T-BSD	Yes	Yes			
525T-PWD	Yes	Yes			
525T-LTD/12	Yes	Yes			
525T-LTD/20	Yes	Yes			
SS60-SLTD/12	Yes	Yes			
SS60-SLTD/20	Yes	Yes			
526TID-HDD	Yes	Yes		XDR1*	1 kW
TM260	Yes	Yes			
50/200-1T	Yes	Yes			
50B-6	No	No			
50B-6B	No	No			
200B-5S	No	No			

* : Connect with the matching box MB-1100 (optional supply).

CHIRP transducers (single frequency)

Model	ACCU-FISH™	Bottom Discrimination	Port to be connected	Power Rating
B75L	No	No	XDR1	300 W
B150M	No	No		
P95M	No	No		
SS75L	No	No		
TM150M	No	No		
B75H	No	No		
B75HW	No	No		
B75M	No	No		
B785M	No	No		
P75M	No	No		
SS75H	No	No		1 kW
SS75M	No	No		
TM165HW	No	No		
B175H	No	No		
B175HW	No	No		
B175L	No	No		

Model	ACCU-FISH™	Bottom Discrimination	Port to be connected	Power Rating
B175M	No	No	XDR1	1 kW
B175MW	No	No		
B285HW	No	No		
B285M	No	No		
M285HW	No	No		
SS175H	No	No		
SS175HW	No	No		
SS175L	No	No		
SS175M	No	No		
SS175MW	No	No		
TM185HW	No	No		
TM185M	No	No		
TM185MW	No	No		

Side Scan transducers

Model	ACCU-FISH™	Bottom Discrimination	Port to be connected	Power Rating
225T-TM904	No	No	XDR2/SIDE SCAN*	150 W
225T-SS904	No	No		
225T-PR904	No	No		
455T-TM903	No	No		
455T-SS903	No	No		
455T-PR903	No	No		

*: Connect directly to the XDR2/SIDE SCAN port.

Combined transducers (TZZ9E/13E only)

Model	ACCU-FISH™	Bottom Discrimination	Port to be connected	Power Rating
165T-50/200-SS260	No	No	XDR1*	1 kW
165T-50/200-TM260	No	No		

*: Connect directly to the XDR1 port.

APPX. 3 ALERT MESSAGES

The table below shows the alert messages that may appear.

Text	Meaning	Remedy
*** -Device Missing- ***	CZone devices can not be found. ** indicates the source Module Type/Name.	Check the connection with CZone devices.
*** -High Battery Capacity Alarm- **	An error is received from the CZone devices.	Refer to the operator's manual for CZone.
*** -High Battery Voltage Alarm- **	An error is received from the CZone devices.	Refer to the operator's manual for CZone.
*** -High Level Alarm- **	An error is received from the CZone devices.	Refer to the operator's manual for CZone.
*** -High Temperature Alarm- **	An error is received from the CZone devices.	Refer to the operator's manual for CZone.
*** -Low Battery Capacity Alarm- **	An error is received from the CZone devices.	Refer to the operator's manual for CZone.
*** -Low Battery Voltage Alarm- **	An error is received from the CZone devices.	Refer to the operator's manual for CZone.
*** -Low Level Alarm- **	An error is received from the CZone devices.	Refer to the operator's manual for CZone.
*** -Low Temperature Alarm- **	An error is received from the CZone devices.	Refer to the operator's manual for CZone.
*** -Very High Level Alarm- **	An error is received from the CZone devices.	Refer to the operator's manual for CZone.
*** -Very High Temperature Alarm- **	An error is received from the CZone devices.	Refer to the operator's manual for CZone.
*** -Very Low Battery Voltage Alarm- **	An error is received from the CZone devices.	Refer to the operator's manual for CZone.
*** -Very Low Level Alarm- **	An error is received from the CZone devices.	Refer to the operator's manual for CZone.
*** -Very Low Temperature Alarm- **	An error is received from the CZone devices.	Refer to the operator's manual for CZone.
"AIS Count 100%"	AIS data containing 1,000 or more targets is received.	This message disappears when the number of AIS targets becomes less than or equal to 999.
"AIS Count 95%"	AIS data containing 950 or more targets is received.	This message disappears when the number of AIS targets becomes less than or equal to 949.
"AIS SART Alarm"	AIS data (including AIS SART) is valid.	This message disappears when AIS data (including AIS SART) is lost. You cannot delete this message manually because this is an emergency warning.
"AIS: New Text Message"	An AIS safety message is received.	Tap [Delete Message] to clear the message.
"Anchor Watch Alarm"	Your ship has moved a distance greater than the value set for the anchor watch alarm.	The notification will disappear when the ship returns within the specified distance.
"Full Auto Tracking ^{*1} Activated"	Full auto tracking is activated.	—

Text	Meaning	Remedy
"Full Auto Tracking *1 Deactivated"	Full auto tracking is deactivated.	–
"Avoidance Route Cleared (Danger Found)"*1	Danger found in the avoidance route.	Take necessary measures to avoid the danger.
"Avoidance Route System Off"*1	The feature is turned off (from the menu).	–
"Avoidance Route System Pause"*1	The avoidance route system is paused for any of these reasons. <ul style="list-style-type: none"> • Latitude/longitude position, SOG/COG, or heading signal missing. • Applicable TZ MAPS has not been purchased, or the information is not saved on the microSD card. • Ship speed is 40 knots or higher. • The capacity for full auto tracking is reached. 	<ul style="list-style-type: none"> • Check applicable navigation sensors. • Purchase TZ MAPS for the area where this function will be used and save the TZ MAPS chart information to a microSD card. • Lower ship speed below 40 knots. • –
"Bird Mode Activated"	The bird mode is turned on.	–
"Bird Mode Deactivated"	The bird mode is turned off.	–
"Boundary Line Crossed"	Your ship has crossed a boundary line.	–
"Cannot intercept target at current speed"	The target cannot be intercepted at the current ship speed.	Raise the ship speed.
"Charge Indicator!"	Engine indicator error.	Refer to the operator's manual for the engine and contact the engine manufacturer.
"Check Engine!"	Engine error.	Refer to the operator's manual for the engine and contact the engine manufacturer.
"CPA/TCPA Alarm"	If the [Collision Alarm] is set for [CPA/TCPA Alarm], this message appears when a AIS target's CPA and TCPA are less than the threshold value. The status of the AIS target changes to "dangerous target".	Take evasive action immediately. Tap "CPA/TCPA Alarm" on the Status bar at the top of the screen to silence the audio alarm and erase the message. To cancel the CPA/TPA alarm, turn off the alarm using the following procedure. Home page→[Settings]→[Targets]→[Collision Alarm]→[Off].
"Demo Mode"	The demo mode is enabled started with the selected demo file.	–
"Depth Alarm"	The depth is lower than the value set for the depth alarm.	Take immediate evasive action to prevent grounding.
"DoS/DDoS attack detection error"	The network is overloaded. Risk of a cyber attack is detected, or there may be devices on the network that are operating abnormally.	<ul style="list-style-type: none"> • Disable the network connection. For LAN: unplug the cable. For wireless LAN: Disable the wireless LAN setting. • Identify the device that is causing the overload and disconnect it.
"DSC Distress Call"	A distress warning is received.	You cannot delete this message manually because this is an emergency warning.

APPX. 3 ALERT MESSAGES

Text	Meaning	Remedy
"DSC Position Report Received"	A non-distress DSC message is received.	This message is erased when a non-distress DSC message is lost.
"EGR System!"	EGR system (engine) error.	Refer to the operator's manual for the engine and contact the engine manufacturer.
"End of Route Notification"	Your ship has arrived at the final destination.	–
"Engine Comm Error!"	Engine error (undetectable condition).	Refer to the operator's manual for the engine and contact the engine manufacturer.
"Engine Emergency Stop Mode!"	Engine indicator (emergency stop mode) error.	Refer to the operator's manual for the engine and contact the engine manufacturer.
"Engine Shutting Down!"	Engine error (stop).	Refer to the operator's manual for the engine and contact the engine manufacturer.
"Fish detected - Bottom"	A fish school is detected within the range set for the bottom lock fish alarm.	–
"Fish Finder Connection Lost"	Connection with the selected fish finder is lost.	–
"Fuel Active Route"	The fuel is expected to run out during the route navigation.	Refill the fuel.
"Fuel Capacity Alarm for Active Route"	Not enough fuel remaining to reach final destination in active route.	Replenish the fuel supply.
"Heading Lost"	No heading data.	Check the connection with the heading sensor. Check the heading sensor.
"High Boost Pressure!"	The discharge pressure of the engine pump is too high.	Refer to the operator's manual for the engine and contact the engine manufacturer.
"In Alarm Zone"	Your ship has entered a boundary line.	–
"Low Coolant Level!"	Engine error (coolant level drop).	Refer to the operator's manual for the engine and contact the engine manufacturer.
"Low Fuel Alarm"	The fuel level is lower than or equal to the value (%) set for the low fuel alarm.	Refill the fuel.
"Low Fuel Pressure!"	Engine error (fuel pressure drop).	Refer to the operator's manual for the engine and contact the engine manufacturer.
"Low Oil Level!"	Engine error (oil level drop).	Refer to the operator's manual for the engine and contact the engine manufacturer.
"Low Oil Pressure!"	Engine error (oil pressure drop).	Refer to the operator's manual for the engine and contact the engine manufacturer.
"Low System Voltage!"	Engine error (voltage drop).	Refer to the operator's manual for the engine and contact the engine manufacturer.
"Maintenance Needed!"	Engine error (maintenance required).	Refer to the operator's manual for the engine and contact the engine manufacturer.
"Manual Demo"	The manual demo mode is enabled.	–
"Max Wind Speed Exceeded"	The wind speed matches the value set for the wind speed alarm.	–
"MOB"	A MOB mark is input.	–
"Multibeam Sonar B Voltage Abnormal"*1	The B voltage of the multibeam sonar is outside the specified value (32.4 to 39.6 V).	Have a qualified technician check the multibeam sonar connections.

Text	Meaning	Remedy
"Multibeam Sonar Disconnection Alarm"*1	Connection with the multibeam sonar is lost.	Check the connection with the multibeam sonar.
"Multibeam SONAR Fish Detected"*1	A school of fish is detected within the range set for the fish alarm of the multibeam sonar.	—
"NAVpilot Connection Lost"	Connection with the NAVpilot is lost.	Check the connection with the NAVpilot. Check that power is supplied to the NAVpilot.
"NAVpilot Disengaged"	Navigation by the NAVpilot is canceled.	—
"NAVpilot Engaged"	AUTO/NAV/WIND/TURN/FISH HUNTER/SABIKI is being performed from STBY on the NAVpilot or the TZT.	—
"Near Alarm Zone"	Your ship is near a boundary line.	—
"Neutral Start Protect!"	Engine error (Neutral Start Protect!).	Refer to the operator's manual for the engine and contact the engine manufacturer.
"NMEA 2000 Logging"	NMEA 2000 log is being recorded.	—
"No Chart Master Detected"	TZT are set for the chart master.	Set the chart master on only one TZT unit. Home page → [Settings] → [Initial Setup] → [Chart Master Device]
"Object Limit Reached"	The user object data has reached the upper limit.	Delete unnecessary user objects to make room. Check the number of used user objects. Home page → [Settings] → [General] → [DATA USAGE]
"Opening Grib File"	The GRIB file (weather information) stored in the TZT is being opened.	—
"Over Temperature!"	Engine error (overheat).	Refer to the operator's manual for the engine and contact the engine manufacturer.
"Position jump alert"	Ship position data error. Risk of a DoS attack (such as GPS spoofing) is detected.	Check information sources (e.g., other GPS sources, own ship's current position as predicted from past positions and heading, etc.) and remove any suspicious GPS sources. Also, check the follows. <ul style="list-style-type: none"> • The ship may be under attack due to jamming/spoofing of GNSS signals (GPS signals). Pay attention when navigating. • Try to change the direction of the GPS antenna. • Check if any suspicious equipment is installed on the ship. • Check the GNSS equipment for malfunction.
"Position Lost"	No positioning data.	Check for objects that may be blocking reception. Check the connection with the GPS antenna. Check the GPS sensor.
"Power Reduction!"	Engine error (power drop).	Refer to the operator's manual for the engine and contact the engine manufacturer.

Text	Meaning	Remedy
"Preheat Indicator"	Engine indicator error.	Refer to the operator's manual for the engine and contact the engine manufacturer.
"Previous SID Disable"	The previously detected chart master has been disabled.	–
"Proximity AIS Target Alarm"	If the [Proximity AIS Target Alarm] is turned on, this message appears when an AIS target is within the distance set.	Take evasive action immediately. To cancel the proximity AIS target alarm, use the following procedure. Home page → [Settings] → [Targets] → [Proximity AIS Target Alarm].
"Radar Azimuth Alarm"	Bearing pulse signal error.	Check the radar antenna. Check the connection with the radar antenna.
"Radar Connection Lost"	Connection with the selected radar sensor is lost.	Reconnect the radar sensor.
"Radar Headline Alarm"	Heading pulse signal error.	Check the reed switch and magnetron of the radar antenna. Check the connection with the radar antenna.
"Radar Trigger Alarm"	Trigger signal error.	Check the radar antenna. Check the connection with the radar antenna.
"Radar Video Alarm"	Video signal error.	Check the radar antenna. Check the connection with the radar antenna.
"Rev Limit Exceeded!"	The engine rotation speed has exceeded the upper limit.	Refer to the operator's manual for the engine and contact the engine manufacturer.
"Safe Helm Activated"	The safe helm function is activated. (The NAVpilot steering mode is temporarily switched to the manual mode.)	–
"Safe Helm Deactivated"	The safe helm function is deactivated.	–
"Scanning Drive"	A microSD chart or a USB flash memory is being loaded,	–
"Sea Surface Temperature Alarm"	The sea surface temperature matches the value set for the sea surface temperature alarm.	–
"Several Chart Master Detected"	Two or more TZT units are set for the chart master.	Set the chart master on only one TZT unit. Home page → [Settings] → [Initial Setup] → [Chart Master Device]
"SID not found ***"	SID is not found. ** is the system ID.	Start TZT with the chart master turned on.
"Sirius Disconnection Alarm"	Connection with the SiriusXM receiver is lost.	Check the connection with the SiriusXM receiver.
"Speed Alarm"	The ship speed matches the value set for the ship speed alarm.	–
"SST Shear detected"	Shear is detected. See subsection 2.12.2.	–
"Sub or Secondary Throttle!"	Engine sub-throttle error.	Refer to the operator's manual for the engine and contact the engine manufacturer.
"TARGET ALARM"	A target has entered the guard zone.	Take evasive action immediately. Tap the guard zone to cancel the alarm.
"Target Analyzer Requires 24NM Range or Less"	The radar sensor is DRS6A-NXT and the target analyzer is set to 24 NM.	Set the target analyzer within the configurable range (within 16 NM).

Text	Meaning	Remedy
"Throttle Position Sensor!"	Throttle opening sensor (engine) error.	Refer to the operator's manual for the engine and contact the engine manufacturer.
"Warning Level 1!"	Engine error (Warning Level 1).	Refer to the operator's manual for the engine and contact the engine manufacturer.
"Warning Level 2!"	Engine error (Warning Level 2).	Refer to the operator's manual for the engine and contact the engine manufacturer.
"Water Flow!"	Engine error (water flow).	Refer to the operator's manual for the engine and contact the engine manufacturer.
"Water in Fuel!"	Engine error (mixture of water in fuel).	Refer to the operator's manual for the engine and contact the engine manufacturer.
"Waypoint Crossing Notification"	Your ship arrived at the destination.	—
"Weather Update in Progress"	The latest weather data is being downloaded from the internet.	This message disappears after the weather data is obtained.
"XTE Alarm"	This alarm alerts you to course deviation.	The notification will disappear when the set course is recovered.
"You are logged as ***"	The data (setting data, points, routes, and tracks) saving on the cloud has been started using the My time zero cloud data service. The User name is displayed in **.	—
"Electric charge"*1	B voltage of capacitors in the transceiver unit have not charged to predetermined voltage within the specified time.	Tap the alarm bar to silence the buzzer, and turn the power off. Contact your dealer.
"No response from transceiver unit"*1	There is no reply from the transceiver unit.	Tap the alarm bar to silence the buzzer. Turn the power off of SONAR, then on again, or turn the transceiver power off from the breaker. If the same problem occurs, contact your dealer.
"Transducer not retracted"*1	The sonar transducer is not retracted within 20 seconds after pressing the key.	Tap the alarm bar to silence the buzzer. The cause may be tangled nets, bent shaft, or faulty in the raise/lower unit. Contact your dealer.
"Transducer not protruded"*1	The sonar transducer is not protruded within 20 seconds after pressing the key.	Tap the alarm bar to silence the buzzer. Turn the transceiver and processor unit of SONAR power off from the breaker. The cause may be faulty in the raise/lower unit. Contact your dealer.
"Transducer wrong position alarm"*1	The sonar transducer is stopped at an incorrect position.	Press key to return the sonar transducer to the correct position, then tap the alarm bar to silence the buzzer.
"Ship speed alarm"*1	Ship's speed exceeded the predetermined speed when the sonar transducer is being raised or lowered.	Tap the alarm bar to silence the buzzer, and reduce the ship's speed.

Text	Meaning	Remedy
"Automatic retract alarm"*1	Ship's speed exceeded the predetermined speed when the sonar transducer is being raised or lowered. The sonar transducer is automatically retracted.	Tap the alarm bar to silence the buzzer.
"TZ MAPS downloading, Route may not be optimal."*1	Downloading the TZ MAPS data. AI routes may not be optimized.	-
"TZ MAPS downloading, Avoidance Route may not be optimal."*1	Downloading the TZ MAPS data. Avoidance routes may not be optimized.	-
"Starting Weather Download"	Started to Download the weather data.	-
"Downloading Weather"	Downloading the weather data.	-
"Extracting Downloaded Data"	Extracting Downloaded Data.	-
"Synchronizing Weather Data"	Synchronizing Weather Data.	-
"Device XXXXX is connected." (XXXXX: indicates device name.)	A new device is connected.	Select [Allow] to allow connection to the device or [Deny] if an unidentified device is detected. If an unidentified device is detected, be aware of the security risk.

*1: Shown on the TZT9E/13E only.

Note: When a sonar-related error (TZT9E/13E only) occurs, the sonar icon and error code are displayed in the status bar at the top of the screen (see the figure below). Refer to the CSH-10 Operator's Manual for the details of the error, its meaning, and remedy.

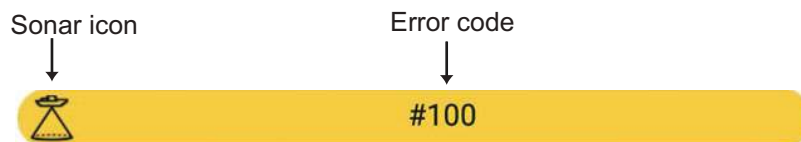

AI routing-related messages

Below are the messages that may appear above the final point icon during creation of an AI route and pop-up messages that may appear after creation ([Done] is tapped). (See subsection 5.2.4).

Message on icon	Message at completion of route	Meaning
No data	<ul style="list-style-type: none"> If you have purchased TZ MAPS for the relevant area: TZtouch cannot complete AI routing because the TZ MAPS vector chart is not installed. Connect to the internet and download the TZ MAPS vector chart. Tap [OK] to download the database. If you have not purchased TZ MAPS for the relevant area: No message is displayed, and the license purchase display is opened. 	The starting point/end point database has not been downloaded.

Message on icon	Message at completion of route	Meaning
On Load	<p>There is no TZ MAPS vector chart data installed for this area. TZtouch is not able to compute your AI routing until the TZ MAPS vector chart data is installed. Would you like to download TZ MAPS vector chart data?</p> <p>Tap [Cancel] to cancel route editing. Tap [OK] to continue.</p>	The starting point/any end point is set on land (including areas that become tidal flats at low tide). or too close to land.
Too Narrow		The starting point/end point is set to a position that is less than or equal to the width of the ship.
Too Far		The final point is set to be more than 500 NM away from the starting point.
No Route Found		The route could not be found because the starting point/any end point is surrounded by land or waterways no larger than the width of the ship.
Too Many Points		Route generation result exceeded 500 points.
Too shallow Note: Shown only when the [Strict Depth Compliance] is set to on.		The starting point/ any of the end points are set at water below the safety depth.

APPX. 4 RADIO REGULATORY INFORMATION

Wireless Interoperability

This product is designed to be interoperable with any wireless LAN product that is based on direct sequence spread spectrum (DSSS) and orthogonal frequency division multiplexing (OFDM) radio technology and to comply with the following standards.

- IEEE Std 802.11b Standard on 2.4 GHz Wireless LAN
- IEEE Std 802.11g Standard on 2.4 GHz Wireless LAN
- IEEE Std 802.11n Standard on 2.4 GHz Wireless LAN

Safety

This product, like other radio devices, emits radio frequency electromagnetic energy. The level of energy emitted by this device, however, is less than the electromagnetic energy emitted by other wireless devices such as mobile phones. This product operates within the guidelines found in radio frequency safety standards and recommendations. These standards and recommendations reflect the consensus of the scientific community and result from deliberations of panels and committees of scientists who continually review and interpret the extensive research literature. In some situations or environments, the use of this product may be restricted by the proprietor of the building or responsible representatives of the applicable organization. Examples of such situations include the following:

- Using this product onboard airplanes, or
- Using this product in any other environment where the risk of interference with other devices or services is perceived or identified as being harmful.

If uncertain of the policy that applies to the use of wireless devices in a specific organization or environment (an airplane, for example), ask for authorization to use this product before turning it on.

Export Regulation

Radio wave certification is necessary at the export destination. The Wireless LAN of this product operates in the 2.4 GHz band, which does not require a license in most countries. However, the conditions for use of the wireless LAN depend on the country or the area.

USA-Federal Communications Commission (FCC)

This device complies with part 15 of the FCC Rules. Operation is subject to the following two conditions:

- (1) This device may not cause harmful interference, and
- (2) This device must accept any interference received, including interference that may cause undesired operation. Any changes or modifications not expressly approved by the party responsible for compliance could void the user's authority to operate the equipment.

Caution: Exposure to Radio Frequency Radiation

- This equipment complies with FCC radiation exposure limits set forth for an uncontrolled environment and meets the FCC radio frequency (RF) Exposure Guidelines in Supplement C to OET65.
- This equipment should be installed and operated keeping the radiator at least 20 cm or more away from person's body.
- This device must not be co-located or operating in conjunction with any other antenna or transmitter.

Innovation, Science and Economic Development Canada (ISED)

This device contains licence-exempt transmitter(s)/receiver(s) that comply with Innovation, Science and Economic Development Canada's licence-exempt RSS(s). Operation is subject to the following two conditions:

- (1) This device may not cause interference.
- (2) This device must accept any interference, including interference that may cause undesired operation of the device.

Cet appareil contient un ou plusieurs émetteurs / récepteurs exempts de licence qui sont conformes à la norme « exempts de licence RSS (s) » Canadienne d'Innovation, Sciences et Développement économique. L'exploitation est autorisée aux deux conditions suivantes:

- (1) l'appareil ne doit pas produire de brouillage.
- (2) l'utilisateur de l'appareil doit accepter tout brouillage radioélectrique subi, même si le brouillage est susceptible d'en compromettre le fonctionnement.

Caution: Exposure to Radio Frequency Radiation

This equipment complies with ISED radiation exposure limits set forth for an uncontrolled environment and meets RSS-102 of the ISED radio frequency (RF) Exposure rules. This equipment should be installed and operated keeping the radiator at least 20 cm or more away from person's body.

Cet équipement est conforme aux limites d'exposition aux rayonnements énoncées pour un environnement non contrôlé et respecte les règles d'exposition aux fréquences radioélectriques (RF) CNR-102 de l'ISED. Cet équipement doit être installé et utilisé en gardant une distance de 20 cm ou plus entre le dispositif rayonnant et le corps.

To reduce potential radio interference to other users, the antenna type and its gain should be so chosen that the equivalent isotropically radiated power (EIRP) is not more than that required for successful communication.

SPECIFICATIONS OF MULTI FUNCTION DISPLAY TZT9E/TZT13E

1 DISPLAY FUNCTION

- | | | |
|-----|-----------------|--|
| 1.1 | Screen | |
| | TZT9E | 9.0-inch wide touch-panel TFT display, 1280 x 720 (HD) |
| | TZT13E | 12.8-inch wide touch-panel TFT display, 1920 x 1080 (FHD) |
| 1.2 | Max. Brightness | 1000 cd/m ² typical |
| 1.3 | View angle | 9.0-inch: 80° typical, 12.8-inch: 85° typical |
| 1.4 | Language | Bulgarian, Chinese, Danish, English (UK/US), Finnish, French, German, Greek, Italian, Japanese, Norwegian, Portuguese, Russian, Spanish, Swedish |

2 CONNECTABLE FISH FINDER/SONAR

DFF Series Network Fish Finder, TZT Series Built-in Fish Finder, Multi-beam Sonar DFF-3D, Scanning Sonar CSH-10

3 PLOTTER FUNCTION

- | | | |
|-----|---------------------------|---|
| 3.1 | Display mode | Course plot, NAV data (includes instrument and engine data) |
| 3.2 | Projection | Mercator |
| 3.3 | Useable area | 85° latitude or below |
| 3.4 | Memory capacity | Track: 100,000 points, Point/MOB: 30,000 points
Route: 200 courses w/500 points each
ARPA: 100 targets (for DRS-NXT series), AIS: 1,000 targets |
| 3.5 | Alarm | Anchor watch, Boundary, Cross track error, Depth*, Low fuel*, Sea surface temperature*, Speed, Wind speed*
(*: external data required) |
| 3.6 | GNSS receiver | |
| | Receiving frequency | 1575.42 MHz |
| | Accuracy | GPS: 2 m CEP, Galileo: 3 m CEP |
| | Position-fixing time | 30 s approx. (Average for 24 hours) |
| | Ship's speed range | 500 m/s max. (all satellites at -130 dBm) |
| | Location update frequency | Up to 10 Hz |

4 RADAR FUNCTION

- | | | |
|-----|------------------|---|
| 4.1 | Orientation mode | Head-up, North-up (heading data required) |
| 4.2 | Echo trail | 15/30 s, 1/3/6/15/30 min. or continuous (heading data required) |
| 4.3 | Alarm | Guard-zone, CPA/TCPA, Video, Azimuth, Heading line |

5 SOUNDER FUNCTION

- | | | |
|-----|-------------|---|
| 5.1 | Frequency | |
| | Fish Finder | CW: 50/200 kHz, CHIRP: 40 to 225 kHz |
| | Side scan | 230/455 kHz |
| 5.2 | Transducer | |
| | Fish Finder | CW: 600 W/1 kW, CHIRP: 300 W/600 W/1 kW |
| | Side scan | 150 W |

- 5.3 Depth range
 - Fish Finder 2 to 1200 m, Shift: 0 to 1200 m
 - Side scan 500 m (to each side)
- 5.4 Display mode ACCU-FISH™, A-scope, Estimation for bottom composition, Temperature graph
- 5.5 Alarm School of fish, School of fish for bottom lock

6 INTERFACE

- 6.1 Number of ports
 - LAN 1 port, Ethernet 100BASE-TX
 - NMEA0183 1 port (Output only)
 - NMEA2000 1 port
 - USB (Type-C) 1 port (For User data in/out and Maintenance)
 - SD card slot 1 port, micro-SDXC
- 6.2 Wireless LAN IEEE802.11b/g/n
 - Transmit Channel 1 to 11 channel
 - Transmit frequency 2.401 to 2.473 GHz
 - Output power 10 dBm max.
- 6.3 Bluetooth Ver.5.2
 - Transmit frequency 2.402 to 2.480 GHz
 - Output power 10 dBm max.
- 6.4 Data sentences NMEA0183
 - Output AAM, APB, BOD, DBT, DPT, GGA, GLL, GNS, GSA, GSV, RMB, RMC, RTE, TTM, VDM, VTG, WPL, XTE, ZDA
- 6.5 NMEA2000 PGN

Input	059392, 059904, 060160, 060416, 060928, 061184, 065240, 065280, 126208, 126464, 126720, 126983, 126985, 126992, 126996, 126998, 127237, 127245, 127250, 127251, 127252, 127257, 127258, 127488, 127489, 127493, 127498, 127503, 127505, 127506, 127508, 128259, 128267, 129025, 129026, 129029, 129033, 129038, 129039, 129040, 129041, 129291, 129538, 129540, 129793, 129794, 129795, 129797, 129798, 129801, 129802, 129808, 129809, 129810, 130306, 130310, 130311, 130312, 130313, 130314, 130316, 130576, 130577, 130578, 130817, 130818, 130820, 130822, 130823, 130826, 130827, 130828, 130845, 130846, 130880
Output	059392, 059904, 060928, 061184, 065287, 126208, 126464, 126720, 126984, 126992, 126993, 126996, 126998, 127250, 127251, 127257, 127258, 128259, 128267, 128275, 129025, 129026, 129029, 129033, 129283, 129284, 129285, 130306, 130310, 130312, 130313, 130314, 130316, 130821, 130822, 130823, 130827, 130841

7 POWER SUPPLY

- 7.1 Multi function display
 - TZT9E 12-24 VDC (10.8-31.2 V): 1.7-0.9 A
 - TZT13E 12-24 VDC (10.8-31.2 V): 2.4-1.2 A

Note: TZT9E/TZT13E uses the non-isolated power circuit.
- 7.2 Rectifier (option)
 - PR-62 100/110/220/230 VAC, 1 phase, 50-60Hz

8 ENVIRONMENTAL CONDITIONS

- 8.1 Ambient temperature -15°C to +55°C (storage: -30°C to +70°C)
- 8.2 Relative humidity 94% or less at +40°C
- 8.3 Degree of protection IPX6
- 8.4 Vibration IEC 60945 Ed.4

8 UNIT COLOR

N1.0

**SPECIFICATIONS OF MULTI FUNCTION DISPLAY
TZMAP9/TZMAP13**

1 DISPLAY FUNCTION

- 1.1 Screen
 - TZMAP9 9.0-inch wide touch-panel TFT display, 1280 x 720 (HD)
 - TZMAP13 12.8-inch wide touch-panel TFT display, 1920 x 1080 (FHD)
- 1.2 Max. Brightness 1000 cd/m² typical
- 1.3 View angle 9.0-inch: 80° typical, 12.8-inch: 85° typical
- 1.4 Language Bulgarian, Chinese, Danish, English (UK/US), Finnish, French, German, Greek, Italian, Japanese, Norwegian, Portuguese, Russian, Spanish, Swedish

2 PLOTTER FUNCTION

- 2.1 Display mode Course plot, NAV data (includes instrument and engine data)
- 2.2 Projection Mercator
- 2.3 Useable area 85° latitude or below
- 2.4 Memory capacity
 - Track: 100,000 points, Point/MOB: 30,000 points
 - Route: 200 courses w/500 points each
 - ARPA: 100 targets (for DRS-NXT series), AIS: 1,000 targets
- 2.5 Alarm
 - Anchor watch, Boundary, Cross track error, Depth*, Low fuel*, Sea surface temperature*, Speed, Wind speed*
 - (*: external data required)
- 2.6 GNSS receiver
 - Receiving frequency 1575.42 MHz
 - Accuracy GPS: 2 m CEP, Galileo: 3 m CEP
 - Position-fixing time 30 s approx. (Average for 24 hours)
 - Ship's speed range 500 m/s max. (all satellites at -130 dBm)
 - Location update frequency Up to 10 Hz

3 RADAR FUNCTION

- 3.1 Orientation mode Head-up, North-up (heading data required)
- 3.2 Echo trail 15/30 s, 1/3/6/15/30 min. or continuous (heading data required)
- 3.3 Alarm Guard-zone, CPA/TCPA, Video, Azimuth, Heading line

4 SOUNDER FUNCTION

- 4.1 Frequency
 - Fish Finder CW: 50/200 kHz, CHIRP: 40 to 225 kHz
 - Side scan 230/455 kHz
- 4.2 Transducer
 - Fish Finder CW: 600 W/1 kW, CHIRP: 300 W/600 W/1 kW
 - Side scan 150 W
- 4.3 Depth range
 - Fish Finder 2 to 1200 m, Shift: 0 to 1200 m
 - Side scan 500 m (to each side)
- 4.4 Display mode ACCU-FISH™, A-scope, Estimation for bottom composition, Temperature graph
- 4.5 Alarm School of fish, School of fish for bottom lock

5 INTERFACE

5.1 Number of ports

LAN	1 port, Ethernet 100BASE-TX
NMEA0183	1 port (Output only)
NMEA2000	1 port
USB (Type-C)	1 port (For User data in/out and Maintenance)
SD card slot	1 port, micro-SDXC

5.2 Wireless LAN

IEEE802.11b/g/n	
Transmit Channel	1 to 11 channel
Transmit frequency	2.401 to 2.473 GHz
Output power	10 dBm max.

5.3 Bluetooth

Ver.5.2	
Transmit frequency	2.402 to 2.480 GHz
Output power	10 dBm max.

5.4 Data sentences

NMEA0183	
Output	AAM, APB, BOD, DBT, DPT, GGA, GLL, GNS, GSA, GSV, RMB, RMC, RTE, TTM, VDM, VTG, WPL, XTE, ZDA

5.5 NMEA2000 PGN

Input	059392, 059904, 060160, 060416, 060928, 061184, 065240, 065280, 126208, 126464, 126720, 126983, 126985, 126992, 126996, 126998, 127237, 127245, 127250, 127251, 127252, 127257, 127258, 127488, 127489, 127493, 127498, 127503, 127505, 127506, 127508, 128259, 128267, 129025, 129026, 129029, 129033, 129038, 129039, 129040, 129041, 129291, 129538, 129540, 129793, 129794, 129795, 129797, 129798, 129801, 129802, 129808, 129809, 129810, 130306, 130310, 130311, 130312, 130313, 130314, 130316, 130576, 130577, 130578, 130817, 130818, 130820, 130822, 130823, 130826, 130827, 130828, 130845, 130846, 130880
Output	059392, 059904, 060928, 061184, 065287, 126208, 126464, 126720, 126984, 126992, 126993, 126996, 126998, 127250, 127251, 127257, 127258, 128259, 128267, 128275, 129025, 129026, 129029, 129033, 129283, 129284, 129285, 130306, 130310, 130312, 130313, 130314, 130316, 130821, 130822, 130823, 130827, 130841

6 POWER SUPPLY

6.1 Multi function display

TZMAP9	12-24 VDC (10.8-31.2 V): 1.7-0.9 A
TZMAP13	12-24 VDC (10.8-31.2 V): 2.4-1.2 A

Note: TZMAP9/TZMAP13 uses the non-isolated power circuit.

6.2 Rectifier (option)

PR-62	100/110/220/230 VAC, 1 phase, 50-60Hz
-------	---------------------------------------

7 ENVIRONMENTAL CONDITIONS

7.1 Ambient temperature	-15°C to +55°C (storage: -30°C to +70°C)
7.2 Relative humidity	94% or less at +40°C
7.3 Degree of protection	IPX6
7.4 Vibration	IEC 60945 Ed.4

8 UNIT COLOR

N1.0

INDEX

Numerics

- 2D/3D switch3-2
- 3D display
 - activating3-2
 - description3-1
 - exaggeration3-3

A

ACCU-FISH

- description6-17
 - fish size correction6-18
 - information6-18
 - setting6-17
 - showing icon on 3D display3-12
 - showing/hiding symbol6-18
- Advanced Wx data14-12

AIS

- buddies list15-8
- CPA/TCPA alarm15-7
- finding target on chart plotter display15-6
- ignoring slow targets15-3
- list15-5
- locating target on chart plotter display ...15-6
- lost target15-2
- nickname of target15-6
- proximity AIS target alarm15-2
- showing/hiding symbols15-1
- target data with pop-up menu15-4
- target details15-6
- target IDs15-4
- target symbols15-1

AIS list15-5

AIS transponder (FA-30, FA-50) setup ..15-10

Alarm sensitivity (fish finder)6-16

Alarms

- alarm menu2-17
- anchor watch2-20
- audio alarm silencing2-16
- aural alarm on/off2-22
- bottom lock fish alarm6-15
- CPA/TCPA7-38, 15-7
- depth2-19
- fish (fish finder)6-15
- fish (multi-sounder display)9-8
- proximity AIS target15-2
- speed2-19
- SST2-18
- XTE2-17

Alarms list2-22

Alert messagesAP-18

Anchor watch alarm

- position averaging2-21
- setting2-20

Antenna

- heading alignment7-42

- main bang suppression7-42
- position7-42
- rotation start, stop7-42
- sector blaning7-42

ARPA

- automatic target acquisition7-32
- clearing lost target7-38
- CPA/TCPA alarm7-38
- full auto tracking7-33
- manual target acquisition7-32
- showing/hiding display7-31
- stop tracking target7-35
- target data7-35

A-scope display6-6

Avoidance route5-25

B

Background color

- fish finder6-25
- radar7-24

Beam angle (multi-sounder display)9-6

Beam type selection (multi-sounder display) ...9-6

Beam width (multi-sounder display)9-7

Bird mode7-26

Bottom discrimination display6-6

Bottom level6-25

Bottom lock display6-4

Bottom lock fish alarm

- activating, deactivating6-16
- sensitivity6-16
- setting6-15

Bottom range shift area6-26

Bottom zoom display6-5

Boundaries

- adding point to4-34
- alarm for4-35
- creating4-26, 4-27
- default attributes4-28
- deleting4-37
- deleting a point, line4-34
- displaying at screen center4-36
- editing4-32, 4-33
- list4-29
- moving a point4-34
- points used4-36
- searching4-30
- showing, hiding4-28
- sorting4-30

Boundaries list4-29

Buddies list15-8

C

Catches list4-12

Chart information2-8

Chart object info2-7

INDEX

- Chart plotter menu 2-36
- Charts
 - adding 16-14
 - deleting 16-16
 - panning 2-4
 - range 2-3
 - updating 16-14
 - vector charts text and object information 2-14
 - viewing 16-14
 - zoom in, zoom out 2-3
- CHIRP ide scan display
 - echo color 8-4
- CHIRP sde scan display
 - TX rate 8-3
- CHIRP side scan
 - depth indication 8-5
 - display example 8-1
- CHIRP side scan display
 - displaying 8-1
 - layers menu 8-2
 - picture advance speed 8-5
 - range 8-4
 - TX and STBY 8-3
- Clutter (fish finder) 6-10
- Color erase 6-12
- Color range expansion 6-22, 6-26
- Community maps
 - activating, deactivating 2-42
 - creating chart objects 2-43
 - deleting chart objects 2-49
 - displaying chart object information 2-50
 - editing chart objects 2-48
 - moving chart objects 2-49
 - setting up display information for chart objects 2-47
 - undoing modification 2-49
- Controls 1-1
- CPA graphic display
 - AIS 15-9
 - radar 7-39
- CPA/TCPA alarm 7-38, 15-7
- Cross section display
 - depth indication 9-13
 - display example 9-5
 - echo smoothing 9-13
 - frequency indication 9-13
 - function availability 9-14
 - gain 9-14
 - grid 9-12
 - layers menu 9-12
 - speed of sound correction 9-13
 - TX and ST-BY 9-12
 - zoom 9-12
- CZone
 - control, operations from slide-out menu 13-17
 - control, operations from instrument display .. 13-16
 - DIP switch settings 13-15
 - modes, operation from instrument display... 13-17
 - modes, operation from slide-out menu... 13-19
 - modes, operations from data window.. 13-18
 - monitoring, data window..... 13-20
 - monitoring, instrument display..... 13-19
 - overview 13-15
 - page addition..... 13-15
 - page editing..... 13-15
- D**
- Data window
 - adding data box..... 1-24
 - changing contents 1-22
 - changing order of data boxes..... 1-22
 - data format (analog or digital) 1-25
 - deleting data box 1-25
 - description 1-21
 - satellite compass data..... 1-26
 - transparency 1-25
- Depth alarm..... 2-19
- Depth measurement..... 6-13
- Depth shading overlay
 - description 3-4
 - settings 3-5
- DI-FFAMP 6-21
- Display brilliance 1-12
- Display icons
 - description 1-14
 - editing..... 1-17, 1-18
 - removing 1-18
- Display selection
 - home screen 1-15
 - quick page 1-15
- DSC list 15-12
- DSC message
 - displaying 15-12
 - DSC list 15-12
 - going to position of 15-11
 - notification of 15-11
- Dual frequency display 6-4
- Dual range radar 7-25
- E**
- EBL
 - bearing measurement with 7-13
 - range measurement with..... 7-14
 - reference 7-14
- Echo average (radar) 7-17
- Echo color
 - CHIRP side scan display..... 8-4
 - radar display 7-23
 - side scan display 9-9
- Echo history 6-13
- Echo stretch 6-26
- Echo trail (radar) 7-19
- Echo trails
 - clearing 7-20
 - color 7-21
 - length 7-20
 - reference 7-20
 - shading 7-21
 - showing, hiding 7-20

- Edge swipe 1-18
- End of route notification 5-22
- Event icon 1-37
- Event marks
 - default settings 4-8
 - entering a comment 4-6
 - entering on chart plotter display 4-3
 - information 4-5
 - introduction 4-1
 - log catch 4-4
- examples, full screen 13-2
- examples, split screen 13-4
- Exporting
 - settings 11-4
 - track 11-3
 - user objects 11-3
- External KP 6-24
- F**
- False echoes
 - fish finder 6-30
 - radar 7-43
- FAX-30 (Facsimile Receiver) setup 16-10
- Files
 - export format 11-2
 - files menu 11-2
- Files menu 11-2
- Fish alarm
 - activating, deactivating 6-16
- Fish alarm (fish finder)
 - setting 6-15
- Fish alarm (multi-sounder display) 9-8
- Fish finder automatic operation 6-8
- Fish finder menu 6-23
- Fish mapping (SiriusXM)
 - data 14-27
 - features 14-22
 - settings 14-27
 - showing display 14-21
- Fish-It
 - operation 2-61
 - showing in pop-up menu 2-60
- Fleet list 2-58
- Fleet tracking
 - centering a fleet target 2-60
 - clearing fleet target symbols 2-57
 - fleet list 2-58
 - fleet target info 2-57
 - fleet target symbol on/off 2-56
 - setting up 2-56
 - sharing user objects 2-60
- Fuel level indicators 5-30
- Fuel management
 - entering fuel tank capacity manually 13-14
 - remaining fuel amount 13-14
- Full auto tracking 7-33
- Function availability
 - cross section display 9-14
 - multi-sounder display 9-8
 - side scan display 9-11
- Fuse replacement 17-2
- FUSION
 - display overview 12-1
 - operation bar 12-2
 - settings 12-3
- G**
- Gain
 - cross section display 9-14
 - fish finder 6-8
 - offset (fish finder) 6-25
 - radar 7-4
 - side scan display 9-10
- Gain offset (fish finder) 6-25
- General menu 16-1
- Grid (cross section display) 9-12
- Guard zone
 - activating, deactivating 7-18
 - setting 7-17
 - showing/hiding 7-18
- H**
- Heading line
 - Own ship icon (chart plotter) 2-5
 - radar 7-16
- Heaving 6-26
- Heaving correction 6-26
- Home icon 1-13, 1-33
- Home screen
 - display selection 1-15
 - editing display icons 1-16
- I**
- Importing
 - settings 11-4
 - settings 11-4
 - tracks 11-4
 - user objects 11-3
- Initial setup menu 16-5
- Instrument display 13-2, 13-4
 - 3-axis display 13-13
 - adding a display 13-12
 - adding indications 13-11
 - editing, indications 13-9
 - rearranging indications 13-8
 - removing a display 13-12
 - removing indications 13-9
 - renaming a display 13-12
 - showing 13-1
 - switching between displays 13-7
 - theme 13-13
- Interference
 - fish finder 6-12
 - radar 7-16
- L**
- Language 1-38
- Layers menu 1-19
- Laylines
 - data 5-31
 - enabling, disabling 5-30

INDEX

polar wind file	5-31
Log catch.....	4-4
Low fuel alarm.....	2-21

M

Magnetron replacement	17-2
Main bang suppression	7-42
Maintenance.....	17-1
MCU-005.....	1-4
MCU-006.....	1-6
Menu tree	AP-1
MicroSD cards	
care of	1-28
formatting	1-28
inserting.....	1-28
removing	1-28
MOB (Man OverBoard)	1-38
MOB mark	1-38
Multi beam sonar	
background color.....	9-1
cross section display example	9-5
menu	9-1
multi-sounder display example.....	9-3
range shift	9-2
side scan display example	9-4
TX rate	9-2
TX start, stop.....	9-1
Multiple echoes (radar)	7-43
Multi-sounder display	
beam angle	9-6
beam type selection	9-6
beam width.....	9-7
depth indication	9-7
display example	9-3
display mode	9-7
fish alarm.....	9-8
frequency indication	9-7
function availability	9-8
layers menu.....	9-6
picture advance speed	9-7
TX and STBY	9-6
My TimeZero	
creating	1-42
logging in to account	1-42

N

NAVpilot	
data box	2-39
enabling use.....	2-38
NAVpilot control box.....	2-38
settings.....	2-42
steering mode	2-39
steering to a point.....	4-24

O

Off center	7-15
Orientation mode	
chart plotter	2-4
radar	7-7
Orientation mode switch	

chart plotter	2-4
radar	7-7
Overlays	
depth shading.....	3-4
radar	3-6, 3-8
tidal currents.....	3-10
tide heights.....	3-8
Own ship icon.....	2-5
Own ship icon (chart plotter)	
COG vector	2-5
heading line	2-5
orientation	2-6
Own ship icon (radar).....	7-23

P

Photos	
deleting.....	2-55
editing photo information.....	2-54
importing	2-53
moving on screen.....	2-53
photo list.....	2-54
Picture advance speed	
CHIRP side scan display.....	8-5
fish finder.....	6-11
multi-sounder display	9-7
side scan display.....	9-10
PIN code	1-44
Points	
default settings	4-6
deleting.....	4-13
deleting collectively	5-14
deleting specific points	4-37
density	4-18
editing.....	4-14, 4-15
editing collectively	4-16
entering from external equipment.....	4-3
entering on chart plotter display	4-2
following with NAVpilot.....	4-24, 5-23
going to on-screen point.....	4-19
goto	4-19, 4-21, 4-23
goto point information.....	4-24
information	4-5
introduction.....	4-1
manual input.....	4-2
moving.....	4-12
moving to screen center	4-17
naming function.....	4-17
points list	4-9
points used display.....	4-8
registering from points list	4-3
registering points	4-3
restarting navigation to.....	4-25
searching.....	4-10
showing/hiding point names.....	4-17
sorting	4-9
stopping navigation to	4-26
Points list.....	4-9
Pop-up window.....	1-19
Power on/off	1-9

- Power switch 1-1, 1-9, 1-12
Proximity AIS target alarm 15-2
- Q**
- Quick page 1-15, 1-19
- R**
- Racon 7-45
Radar overlay
description 3-6
settings 3-7
Radio regulatory information AP-26
Rain clutter 7-7
Range
chart plotter 2-3
CHIRP side scan display 8-4
fish finder 6-8
radar 7-7
side scan display 9-9
Range and bearing measurement
chart plotter 2-10
radar 7-10, 7-15
Range measurement
chart plotter 2-7
fish finder 6-13
Range rings
bearing mode 7-9
description 7-8
interval 7-9
Remote control unit
group setting 1-7
MCU-005 1-4
MCU-006 1-6
Rez boost 7-29
Risk visualizer 5-24
Route Details window 5-19
Routes
auto zoom at arrival to go to point 5-22
color 5-33
continuing navigation at end of route 5-23
creating 5-2, 5-3
creating from points list 5-4
creating with current track 2-29
creating with past track 2-28
cruising speed for planning 5-34
deleting 5-14
deleting all 5-15
deleting points, route points 5-7
deleting selectively 5-14
density 5-15
description 5-1
detailed information 5-19
editing 5-11
end of route notification 5-22
extending 5-7
finding on chart 5-13
following 5-16, 5-17
following in reverse direction 5-20
inserting route points 5-6
moving route points 5-6
restarting navigation 5-20
route details window 5-19
routes list 5-7
routes menu 5-32
routes used 5-13
searching 5-8
showing, hiding 5-15
showing, hiding active route on radar 7-23
skipping a route point 5-21
starting navigation 5-18
steering with NAVpilot 5-23
stop following 5-21
thickness 5-33
waypoint arrival notification 5-22
waypoint switching mode 5-21
XTE lines 5-22
Routes list 5-7
Routes menu 5-32
RX band (fish finder) 6-25
- S**
- Safety instructions iii
SAR 5-27
SART 7-45
Satellite photo overlay 3-6
Sea clutter 7-6
Sector blaning (antenna) 7-42
Sector blanking 7-44
Sensor icons 1-14
Settings
exporting 11-4
Settings menu 1-33
Side scan display
depth indication 9-10
display example 9-4
echo color 9-9
frequency indication 9-10
function availability 9-11
gain 9-10
layers menu 9-9
picture advance speed 9-10
range 9-9
TX and ST-BY 9-9
Sidelobe echoes 7-44
Single frequency display 6-2
SiriusXM radio
controls 14-19
diagnostics 14-20
enabling 14-18
SiriusXM weather
advanced Wx data 14-12
animation radar 14-13
data availability 14-14
diagnostics 14-18
icons overview 14-14
setup 14-11
Wx radar 14-12
Slide-out menu 1-19
Soft cover 1-1

INDEX

- Software update 16-11
- Speed alarm 2-19
- SST alarm 2-18
- Stand-by (radar) 7-2
- System configuration xx
- T**
- Target analyzer 7-27
- Temperature graph 6-20
- Tidal current graph 3-11
- Tidal currents overlay
 - displaying 3-10
 - icon size 3-11
 - tidal currents graphic 3-11
- Tide graph 3-9
- Tide heights overlay
 - displaying 3-8
 - tide icon size 3-9
- Tide info overlay
 - tide graph 3-9
- Tideheights overlay
 - tide heights graphic 3-9
- TIMEZERO
 - exporting data to cloud 11-5
 - restoring data from cloud 11-5
- Touch screen operations 1-2
- Track
 - color 2-25, 2-28
 - creating route with current track 2-29
 - creating route with past track 2-28
 - deleting 2-34
 - deleting all 2-35
 - deleting selectively 2-32, 2-35
 - description 2-23
 - importing 11-4
 - interval 2-24
 - list 2-30
 - points used display 2-33
 - recording 2-23
 - searching 2-31
 - showing/hiding 2-23
 - thickness 2-28
- Track back 2-29
- Tracks
 - exporting 11-3
- Tracks list 2-30
- Transducer draft 6-24
- Transducer setup 6-24
- Transmission power 6-24
- Troubleshooting
 - chart plotter 17-3
 - fish finder 17-4
 - general 17-3
 - radar 17-4
- Tuning 7-4
- TVG 6-14
- Two-finger tap function 1-36
- TX and ST-BY
 - cross section display 9-12
 - radar 7-3
 - side scan display 9-9
- TX and STBY
 - CHIRP side scan display 8-3
- TX/Standby switch 7-3
- TZ iboat 2-51
- TZ weather
 - Data availability 14-14
 - Data download 14-5
 - Displaying 14-6
 - Setting 14-3
- U**
- Units menu 16-3
- User objects
 - exporting 11-3
 - importing 11-3
- V**
- Virtual image 7-43
- VRM
 - fish finder 6-13
 - radar 7-11, 7-12
- W**
- Watchman 7-19
- Waypoint arrival notification 5-22
- Waypoint switching mode 5-21
- Weather display
 - advanced Wx data 14-13
 - animation radar 14-13
 - Data description 14-16
 - introduction 14-1
 - selecting 14-1
 - SiriusXM 14-9
 - TZ weather setup 14-3
- Welcome screen 1-9
- Wireless LAN
 - connect to existing 1-40
 - creating network 1-41
- X**
- XTE alarm 2-17
- XTE lines 5-22
- Z**
- Zero line 6-27
- Zoom display selection (fish finder) 6-4

FURUNO Warranty Information

FURUNO Worldwide Warranty for Pleasure Boats (Except North America)

For purchases outside of the Americas and Caribbean, contact your local Furuno National Distributor.

FURUNO Warranty for North America

The Furuno USA Limited Warranty applies for products purchased in the Americas. Please visit FurunoUSA.com/warranty for more details.



Warranty Registration and Information

To register your product for warranty, as well as see the complete warranty guidelines and limitations, please visit www.furunousa.com and click on "Support". To expedite repairs, warranty service on Furuno equipment is provided through its authorized dealer network. If this is not possible or practical, please contact Furuno U.S.A., Inc. to arrange warranty service.

FURUNO USA Inc.
4400 NW Pacific Rim Blvd
Camas, WA 98607
Telephone: (+1) 360-834-9300
www.FurunoUSA.com



www.furuno.com

FURUNO Electric Company, January 1, 2025

Declaration of Conformity

[TZMAP9/TZMAP13/TZT9E/TZT13E]

Bulgarian (BG)	C настоящото Furuno Electric Co., Ltd. декларира, че гореспоменат тип радиосъоръжение е в съответствие с Директива 2014/53/ЕС, СИ 2017/1206. Цялостният текст на ЕС/УК декларацията за съответствие може да се намери на следния интернет адрес:
Spanish (ES)	Por la presente, Furuno Electric Co., Ltd. declara que el tipo de equipo radioeléctrico arriba mencionado es conforme con la Directiva 2014/53/UE, SI 2017/1206. El texto completo de la declaración de conformidad de la EU/UK está disponible en la siguiente dirección Internet:
Czech (CS)	Týmto Furuno Electric Co., Ltd. prohlašuje, že výše zmíněné typ rádiového zařízení je v souladu se směrnicí 2014/53/EU, SI 2017/1206. Úplné znění EU/SK prohlášení o shodě je k dispozici na této internetové adrese:
Danish (DA)	Hermed erklærer Furuno Electric Co., Ltd., at ovennævnte radioudstyr er i overensstemmelse med direktiv 2014/53/EU, SI 2017/1206. EU/UK-overensstemmelseserklæringens fulde tekst kan findes på følgende internetadresse:
German (DE)	Hiermit erkläre die Furuno Electric Co., Ltd., dass der oben genannte Funkanlagentyp der Richtlinie 2014/53/EU, SI 2017/1206 entspricht. Der vollständige Text der EU/UK-Konformitätserklärung ist unter der folgenden Internetadresse verfügbar:
Estonian (ET)	Käesolevaga deklareerib Furuno Electric Co., Ltd., et ülalmainitud raadioseadme tüüp vastab direktiivi 2014/53/EL, SI 2017/1206 nõuetele. EL/GB vastavusdeklaratsiooni täielik tekst on kättesaadav järgmisel internetiaadressil:
Greek (EL)	Με την παρούσα η Furuno Electric Co., Ltd., δηλώνει ότι ο προαναφερθέντας ραδιοεξοπλισμός πληροί την οδηγία 2014/53/ΕΕ, SI 2017/1206. Το πλήρες κείμενο της δήλωσης συμμόρφωσης ΕΕ/UK διατίθεται στην ακόλουθη ιστοσελίδα στο διαδίκτυο:
English (EN)	Hereby, Furuno Electric Co., Ltd. declares that the above-mentioned radio equipment type is in compliance with Directive 2014/53/EU, SI 2017/1206. The full text of the EU/UK declaration of conformity is available at the following internet address:
French (FR)	Le soussigné, Furuno Electric Co., Ltd., déclare que l'équipement radioélectrique du type mentionné ci-dessus est conforme à la directive 2014/53/UE, SI 2017/1206. Le texte complet de la déclaration UE/RU de conformité est disponible à l'adresse internet suivante:
Croatian (HR)	Furuno Electric Co., Ltd. ovime izjavljuje da je gore rečeno radijska oprema tipa u skladu s Direktivom 2014/53/EU, SI 2017/1206. Cjeloviti tekst EU/UK izjave o sukladnosti dostupan je na sljedećoj internetskoj adresi:
Italian (IT)	Il fabbricante, Furuno Electric Co., Ltd., dichiara che il tipo di apparecchiatura radio menzionato sopra è conforme alla direttiva 2014/53/UE, SI 2017/1206. Il testo completo della dichiarazione di conformità UE/RU è disponibile al seguente indirizzo Internet:
Latvian (LV)	Ar šo Furuno Electric Co., Ltd. deklarē, ka augstāk minēts radioiekārta atbilst Direktīvai 2014/53/ES, SI 2017/1206. Pilns ES/AK atbilstības deklarācijas teksts ir pieejams šādā interneta vietnē:
Lithuanian (LT)	Aš, Furuno Electric Co., Ltd., patvirtinu, kad pirmiau minėta radijo įrenginių tipas atitinka Direktyvą 2014/53/ES, SI 2017/1206. Visas ES/JK atitikties deklaracijos tekstas prieinamas šiuo interneto adresu:
Hungarian (HU)	Furuno Electric Co., Ltd. igazolja, hogy fent említett típusú rádióberendezés megfelel a 2014/53/EU, SI 2017/1206 irányszabványnak. Az EU/EK-megfelelőségi nyilatkozat teljes szövege elérhető a következő internetes címen:
Maltese (MT)	B'dan, Furuno Electric Co., Ltd., niddikjara li msemmija hawn fuq-tip ta' tagħmir tar-radju huwa konformi mad-Direttiva 2014/53/UE, SI 2017/1206. It-test kollu tad-dikjarazzjoni ta' konformità tal-UE/RU huwa disponibbli f'dan l-indirizz tal-Internet li ġej:
Dutch (NL)	Hierbij verklaar ik, Furuno Electric Co., Ltd., dat het hierboven genoemde type radioapparatuur conform is met Richtlijn 2014/53/EU, SI 2017/1206. De volledige tekst van de EU/VK-conformiteitsverklaring kan worden geraadpleegd op het volgende internetadres:
Polish (PL)	Furuno Electric Co., Ltd. niniejszym oświadcza, że wyżej wymieniony typ urządzenia radiowego jest zgodny z dyrektywą 2014/53/UE, SI 2017/1206. Pełny tekst deklaracji zgodności UE/UK jest dostępny pod następującym adresem internetowym:
Portuguese (PT)	O(a) abaixo assinado(a) Furuno Electric Co., Ltd. declara que o mencionado acima tipo de equipamento de rádio está em conformidade com a Diretiva 2014/53/UE, SI 2017/1206. O texto integral da declaração de conformidade da EU/UK está disponível no seguinte endereço de Internet:
Romanian (RO)	Prin prezenta, Furuno Electric Co., Ltd. declară că echipamentul radio menționat mai sus este în conformitate cu Directiva 2014/53/UE, SI 2017/1206. Textul integral al declarației de conformitate UE/RU este disponibil la următoarea adresă internet:
Slovak (SK)	Furuno Electric Co., Ltd. týmto vyhlasuje, že vyššie spomínané rádiové zariadenie typu je v súlade so smernicou 2014/53/EÚ, SI 2017/1206. Úplné EÚ/SK vyhlásenie o zhode je k dispozícii na tejto internetovej adrese:
Slovenian (SL)	Furuno Electric Co., Ltd. potrjuje, da je zgoraj omenjeno tip radijske opreme skladen z Direktivo 2014/53/EU, SI 2017/1206. Celotno besedilo izjave EU/ZK o skladnosti je na voljo na naslednjem spletnem naslovu:
Finnish (FI)	Furuno Electric Co., Ltd. vakuuttaa, että yllä mainittu radiolaitetyyppi on direktiivin 2014/53/EU, SI 2017/1206 mukainen. EU/UK-vaatimustenmukaisuusvakuutuksen täysimittainen teksti on saatavilla seuraavassa internetosoitteessa:
Swedish (SV)	Härmed försäkrar Furuno Electric Co., Ltd. att ovan nämnda typ av radioutrustning överensstämmer med direktiv 2014/53/EU, SI 2017/1206. Den fullständiga texten till EU/Storbritannien-försäkran om överensstämmelse finns på följande webbadress:

Online Resource

http://www.furuno.com/en/support/red_doc

Notice for radiated immunity

The test for the radiated immunity is performed up to 2.7 GHz only without the special condition of spot frequency being applied. There is a chance that this equipment may interfere with allocated services in the frequency range of 2.7 GHz to 6 GHz, particularly in harbors, rivers, lake banks, etc.